

# The Northville Record

WAYNE COUNTY, MICHIGAN ESTABLISHED 1869

Vol. 129, No. 29 Five Sections, 54 Pages, Plus Supplements

CHICAGO

Periodical FIFTY CENTS

## 2nd bond try to seek same \$61.5 million

By ROBERT JACKSON  
Staff Writer

Northville Public School District officials are a little closer to deciding when they will seek voter approval for a second bond issue.

The Northville Board of Education met with members of the citizens bond committee and members of Continuing Excellence for Northville Children on Monday to hash out a plan of action for bringing a \$61.5 million bond issue before district

voters

The bonds would be used to construct a new high school, convert the current high school into a middle school, provide existing building renovations and repairs, and fund new technology.

The board quickly tossed aside plans for an April election. School Superintendent Leonard Rezmierski said that an April election would pose too many problems, and wouldn't provide sufficient time to garner community support.

"A vote in April would literally be a sprint for us," he said. "The timeline for getting all the necessary paperwork into the state and treasury departments would be tight."

"We also believe that the election would be to close to the city's road millage election that is scheduled for March," he added. "And finally we don't feel we would have enough time to get information to the public."

The district lost a bond and enhance-

ment millage election in September by a relatively narrow margin.

Citizen bond committee members unanimously reconfirmed their original recommendation to the board to seek voter approval for a \$61.5 million bond. The committee met several times in December.

Other bond related issues for board consideration are:

- The board will be deciding in the next few weeks, whether to schedule an election in early summer - June was named

as a possible target. The latest the district would want to go is September, according to Rezmierski.

• Whether to keep all of the issues in one single question, or allow voters to pick and choose what portions they will approve. "Unbundling" the issues was recommended by the citizens technology committee at a recent committee meeting, but according to technology member Mark Vernachia, the committee doesn't have a

Continued on 6



PHOTO BY JOHN HEIDER

### Here goes nothin'

Karen Dye and her daughter Tara, 5, take advantage of the recent snowfall to get in some sledding near Northville High School. During this particular run, the pair only got

about halfway down the hill before toppling over. Fortunately, no harm was done and the daring duo were right back in the saddle ready for another try.

### HOW THE SCHOOLS STACK UP

Here's a breakdown of 1996 MEAP scores by school. The scores represent the percentage of students who scored in the satisfactory category on the test.

FOURTH GRADE	MATH		READING	
	%	Rank	%	Rank
Amerman	91.3	3	76.7	3
Moraine	96.4	1	81.8	2
Silver Springs	78.8	5	51.9	5
Thornton Creek	96.0	2	85.3	1
Winchester	89.2	4	73.5	4

SEVENTH GRADE	MATH		READING	
	%	Rank	%	Rank
Cooke	85.2	2	72.9	1
Meads Mill	87.5	1	62.9	2

## Test results prompt real estate inquiries

By ROBERT JACKSON  
Staff Writer

When the Northville Public Schools fourth and seventh grade Michigan Educational Assessment Program test results appeared in the newspaper last week, the district's phone lines began to light up.

"We always get calls when the results come out," said Superintendent Leonard Rezmierski. "The local real estate agents get a hold of them and that's when we begin to get phone calls from people interested in our schools."

The curious parties are usually homebuyers who are interested in the type of education provided by local schools. Fortunately for Northville, the yearly MEAP results continue to show steady improvement by the local schools, and that could translate to higher home sales.

For Rezmierski and school officials, however, the emphasis isn't on attracting homebuyers. Educators in Northville are interested in one thing - improving educational quality in schools.

So Rezmierski views this year's first crop of MEAP results as a positive step towards quality improvement. Last week the school district released the results from MEAP tests taken by fourth and seventh grade students. The results show that fourth graders improved in math and reading and seventh graders improved in reading. The district's overall ratings place it among the top three school districts in southeast Michigan.

The tests were taken Oct. 1-11, 1996.

Northville schools rated much higher than average on both fourth and seventh grade scores. District fourth graders scored 26 points

### Districts seek change in test date

By WENDY PIERMAN MITZEL & ROBERT JACKSON  
Staff Writers

Northville and Novi School officials, along with other districts around the state, are being asked to consider moving all state standardized testing to a two week period in February.

According to Rita Traynor, assistant superintendent for Novi Schools, that may not be a bad idea.

"I think people are going to say 'Hey, that's great.' But that's just my observation," she said.

"It seems to me to be more logical. That way you're only concentrating for two weeks, not the fall and the spring at the (various) grade levels," she explained.

Traynor said she and the principals of the schools, along with some other staff, will talk about the issue and submit a letter of recommendation to the state by Jan. 27.

"That sounds like a good idea to me," added Ann Newton, Novi School Board trustee. "Anything they can do to consolidate and speed along the process and get the tests graded and returned in a

Continued on 6

higher than the statewide average in reading and 30 points higher in math.

At the seventh grade level dis-

Continued on 6

### PAUL FOLINO • 1929-1997

## Community mourns loss of a favorite son

### Ex-councilman remembered as scrappy, big-hearted

By ROBERT JACKSON  
Staff Writer

Paul Folino was a fighter his entire life.

The former Northville city councilman spent the better part of three decades fighting to keep this small city a quaint, inviting place to live while at the same time striving to promote the growth of business and commerce in the downtown area.

He always fought the good fight, said friend and current councilman Chuck Keys, "there was never a moment that Paul wasn't fight-

ing for the good of this community."

Folino's fight ended early Saturday morning, when he died in his sleep at Angela Hospice in Livonia after a six-month bout with cancer. He was 67.

Funeral services for the lifetime Northville resident were held Wednesday at Our Lady of Victory Catholic Church, where Folino was a parishioner. He was buried at Rural Hill Cemetery. Arrangements were made by Casterline Funeral Home in Northville.

Surviving are his wife, Mamie,

daughters Teresa and Paula, Folino Downey, son-in-law Gary Downey, brother Steve, and sister Jennie Watson.

Folino had been in and out of hospitals since undergoing surgery to remove a cancerous tumor from his stomach in October. Family members and close friends prepared for the worst at the beginning of December when the popular Northville native slipped in and out of a coma.

"Everyone was thinking he wouldn't make it to Christmas, but

Continued on 7



Paul Folino in a 1981 photo.

## Candlelight procession pays tribute to slain leader

By RANDY COBLE  
Staff Writer

"I have a dream that my four little children will one day live in a nation where they will not be judged by the color of their skin but by the content of their character."

Martin Luther King Jr. spoke those words in the shadow of the Lincoln Memorial in August 1963. The man is dead but his dream lives on.

For many in America, Monday was just another day. For a few, including some in Northville, Jan. 20 was a day to remember.

Continued on 17



### Beanie bunch

No, it wasn't an invasion of the Beanie Babies, though the cuddly little creatures did appear to be taking over. Last week, Richard Tabor's fourth grade class at Amerman Elementary School pooled all their Beanie Babies after a student discovered that class members owned 300 of them in their personal collections. Showing off the furry piles are classmates (from left) Sarah Manley, Heather Zinser and Nicholas Mizera.

Photo by SUE SPILLANE

### Inside

- Business . . . . . 1D
- Classifieds . . . . . 4D
- Community Calendar . . . . . 2A
- Editorials . . . . . 18A
- Letters . . . . . 19A
- Library Lines . . . . . 12A
- Mill Race Matters . . . . . 20A
- Movies . . . . . 7B
- Obituaries . . . . . 16A
- Our Town . . . . . 1B
- Police News . . . . . 4A
- Sports . . . . . 8B

NEWS/SPORTS . . . 349-1700  
ADVERTISING . . . 349-1700  
CLASSIFIEDS . . . 348-3024  
HOME DELIVERY . . . . 349-3627  
FAX NUMBER . . . . 349-1050

© 1997 HomeTown Newspapers™  
All Rights Reserved

In today's issue



A special section . . .

# PRICE SLICER

Community Calendar

Got an event you want people to know about? We'll be glad to include it in the Community Calendar. Submit items to the newspaper office, 104 W. Main, Northville 48167...

THURSDAY, JANUARY 23

SENIOR PINOCHLE: Area seniors are invited to play pinochle from 12:30-4:30 p.m. at the Senior Center, 215 W. Cady in the Scout Building.

GREAT BOOKS DISCUSSION GROUP: The group meets from 7:30 to 9:30 p.m. at the Livonia Civic Center Library, 32777 Five Mile, east of Farmington...

FRIDAY, JANUARY 24

OES: The Orient Chapter, No. 77, Order of the Eastern Star, meets at 7:30 p.m. at the Masonic Temple.

SUNDAY, JANUARY 26

SINGLE PLACE SUNDAY MORNING GATHERING: Single Place will meet from 10-10:45 a.m. in the library lounge at First Presbyterian Church, 200 E. Main...

SINGLE PLACE BRUNCH: Single Place will meet at 12:30 p.m. for brunch at Northville Crossing Restaurant, 18900 Northville Rd. The group is organized for the purpose of providing friendship, caring and sharing...

MONDAY, JANUARY 27

SENIOR PINOCHLE: Area seniors are invited to play pinochle today and Thursday from 12:30-4:30 p.m. at the Senior Center, 215 W. Cady in the Scout Building.

SENIOR BRIDGE GROUP: Area seniors are invited to play bridge today and Wednesday from 12:15-3:30 p.m. at the Senior Center, 215 W. Cady in the Scout Building.

KIWANIS: The Northville Kiwanis Club meets at 6:30 p.m. at VFW Post 4012, 438 S. Main.

BUSINESS AND PROFESSIONAL WOMEN: The Northville Business and Professional Women meet at 6 p.m. at the Holiday Inn, Laurel Park, Livonia...

BOARD OF EDUCATION: The Northville Public School Board of Education meets at 7:30 p.m. at Old Village School, 405 W. Main St.

NORTHVILLE MASONIC ORGANIZATION: The Northville Masons meet at 7:30 p.m. at the Masonic Temple, Main near Center Street.

TUESDAY, JANUARY 28

NYA ADVISORY COUNCIL: The Northville Youth Assistance Advisory Council meets at 8:30 a.m. in Cooke Middle School, room 2.

SENIOR VOLLEYBALL: Area seniors are invited to play volleyball and other indoor sports at 9:30 a.m. at the Northville Community Center, 303 W. Main...

NORTHVILLE ROTARY: The Northville Rotary Club meets at noon in the Ball Fellowship Hall at the First Presbyterian Church of Northville.

F.E.M.A.L.E.: The Novi Chapter of Formerly Employed Mothers at the Leading Edge meets at 7 p.m. at the Providence Mission Health Center, 39500 W. Ten Mile Rd...

VFW: Veterans of Foreign Wars Northville Post 4012 meets at 8 p.m. at the post's home building, 438 S. Main.

CITY PLANNERS: The Northville Planning Commission meets at 8 p.m. at Northville City Hall, 215 W. Main.

EAGLES AUXILIARY: The auxiliary of Fraternal Order of Eagles No. 2504 meets at 8 p.m. at 113 S. Center.

SUNDAY, FEBRUARY 2

SINGLE PLACE SUNDAY MORNING GATHERING: Single Place will meet from 10-10:45 a.m. in the library lounge at First Presbyterian Church, 200 E. Main...

SINGLE PLACE BRUNCH: Single Place will meet at 12:30 p.m. for brunch at Northville Crossing Restaurant, 18900 Northville Rd. The

group is organized for the purpose of providing friendship, caring and sharing for all single adults. Everyone is welcome; just come in and ask for Single Place.

MONDAY, FEBRUARY 3

SENIOR PINOCHLE: Area seniors are invited to play pinochle today and Thursday from 12:30-4:30 p.m. at the Senior Center, 215 W. Cady in the Scout Building.

SENIOR BRIDGE GROUP: Area seniors are invited to play bridge today and Wednesday from 12:15-3:30 p.m. at the Senior Center, 215 W. Cady in the Scout Building.

KIWANIS: Northville Kiwanis meets at 6:30 p.m. at VFW Post 4012, 438 S. Main.

ATHLETIC BOOSTERS: The Northville High School Athletic Boosters meet at 7 p.m. in the Forum at the high school.

MOTOR CITY SPEAK EASY TOASTMASTERS CLUB: The Motor City Speak Easy Toastmasters Club of Northville meets from 7 to 9 p.m. at the First United Methodist Church, 777 W. Eight Mile...

NORTHVILLE MASONIC ORGANIZATION: Northville Masons meet at 7:30 p.m. at the Masonic Temple.

NORTHVILLE CITY COUNCIL: The Northville City Council meets at 7:30 p.m. at City Hall, 215 W. Main.

TUESDAY, FEBRUARY 4

NYA COMMISSION: The Northville Youth Assistance Commission meets at 8 a.m. Please call the NYA Office at 344-1618 for location.

SENIOR VOLLEYBALL: Area seniors are invited to play volleyball and other indoor sports at 9:30 a.m. at the Northville Community Center, 303 W. Main...

NORTHVILLE ROTARY: The Northville Rotary Club meets at noon in the Ball Fellowship Hall at the First Presbyterian Church of Northville, 200 E. Main.

MIDWEST RADIO CONTROL SOCIETY: The Midwest Radio Control Society meets from 7 to 9 p.m. at the Community Center, 303 W. Main. A youth program is also available...

First baby gets gifts to drool over

The early bird might get the worm, but Northville's first baby gets a whole nest of goodies. The first new arrival of 1997 might have missed out on qualifying for a tax deduction for 1996...

- 10 half gallons of milk from Guernsey Farms Dairy; A \$50 savings account in the name of the child from Community Federal Credit Union; A \$50 gift certificate from Art Source; A bottle of champagne from Good Time Party Store and Deli.

itself could have taken place anywhere. The exact time of birth must be verified by an attending physician.

- All announcements must be received by The Northville Record by noon Friday, Jan. 31. Send information to: First Baby Contest, 104 W. Main, Northville, MI 48167. The winner will be announced in the Feb. 6 edition of The Northville Record.

- Here's a rundown on what we're giving away in this year's Northville Record First Baby contest: A Lamaze infant development system, phase I from Ultimate Toys & Gifts; A children's step stool from The Sawmill; Dinner for the proud mom and dad at MacKinnon's in Northville; A \$50 gift certificate from Baby Baby, consignment clothes; A baby's birthday cake from Northville Gourmet & Wine Shoppe; A 14-K gold baby bootie with charm and genuine birthstone from Northville Diamond Jewelers; Birth announcements from Stampeddler Plus; A photo album, a first-year sticker calendar and a bunny from Hallmark;

Pebble Creek Golf Club. Join us for our EVERY FRIDAY Fish Fry \$5.95 FREE. Piece of Pie with a Fish Dinner expires 1-31-97. 24095 Currie Road, South Lyon (810) 437-5411.

UNIQUE SPA. Relaxation A + Massage. Special 20% OFF w/coupon Expires 1-31-97. 8023 W. Grand River, Brighton Exit 145 I-96 West 810-220-0400

Insulation Special. 6" R-14 Fiberglass Blown in Attic Insulation, 1,000 Sq. Ft. - \$389. JONES INSULATION 348-9880

When You Insure Your Home and Car With Us, You'll Save \$\$\$!. Auto-Owners Insurance. Life Home Car Business. The "No Problem" People. C. HAROLD BLOOM INSURANCE 108 W. Main, Northville 349-1252

COMPUTERIZE Inc. IBM COMPATIBLE COMPUTERS. CD ROM, DIGITAL DISPLAY CASE - MSX OR DESKTOP, 3.5" or 5.25" FLOPPY DRIVE, SERIAL/PARALLEL PORTS, 4 MEG RAM - 50 RAM ADD \$50, 104 KEY WINDS STYLE KEYBOARD, SINGLE COLOR MONITOR 200P NON-RT, 514 VHS CASO 1 MEG RAM PC, 256K PEELTED CACHE MOTHERBOARD, 180 MEG HARD DRIVE 1.2 GIG ADD \$50, 3 YEAR WARRANTY PARTS AND LABOR. PENTRUM-75 \$850, PENTRUM-100 \$875, PENTRUM-120 \$900, PENTRUM-133 \$950, PENTRUM-150 \$1000, PENTRUM-166 \$1150, PENTRUM-200 \$1450, PENTRUM-200 200 \$1800. 15076 MIDDLEBELT, LIVONIA 313-427-0102. Mon.-Fri., 10-8 • Sat., 10-6 • Closed Sun.

THE NORTHVILLE RECORD. Published Each Thursday By The Northville Record 104 W. Main Street Northville, Michigan, 48167. Periodical At Northville, Michigan. Subscription Rates: Inside Counties \$26 one year, Outside Counties (In Michigan) are \$32 per year, prepaid. Out of state, \$35 per year, \$100 per year for foreign countries. HomeTown Newspapers™. A Subsidiary of Suburban Communications Corp. Postmaster, send address changes to: The Northville Record, Post Office Box 470, Howell, MI 48844. POLICY STATEMENT. All advertising published in HomeTown Newspapers™ is subject to the conditions stated in the applicable rate card, copies of which are available from the advertising department, The Northville Record, 104 W. Main Street, Northville, Michigan, 48167. (810-349-1700). HomeTown Newspapers™ reserves the right not to accept an advertiser's order. HomeTown Newspapers™ ad-takers have no authority to bind this newspaper and only publication of an advertisement shall constitute final acceptance of the advertiser's order. Postmaster, send address changes to: The Northville Record, Post Office Box 470, Howell, MI 48844. Publication Number USPS 396880.

Wanted. QUALITY HOME FURNISHINGS AND DECORATIVE ACCESSORIES. Since we moved and expanded, business is booming!! If you're not using it, sell it!! SPECIAL FREE PICKUP. Offer good thru Thurs. Feb. 6th. Call today for appointment. CONSIGNMENT Interiors. HIGHLAND LAKES SHOP. CENTER OPEN 7 DAYS 347-4731

Fair Friendly Recommended. collex COLLISION EXPERTS. "Doing nice things for people and the cars they drive." \$75.00 Interior Detailing FREE With Repair (mention this ad). Now Open. LIVONIA Warren Macomb Sterling Hgts Rochester Hts. 24820 How Road (Corner Auto Service & More) (810) 342-4300. 12717 Warren (313) 255-9199.

HEALTH NOTE by Dennis E. Engerer, P.T. STRETCHING THINGS A BIT. Stretching is a very important part of any exercise program because it is the best way to improve flexibility. And, it is flexibility that enables us to operate up to the full range of motion for which our muscles and joints were designed. The trick to stretching is to not overdo it. When a muscle stretches farther than it is capable of going, a phenomenon known as the stretch reflex kicks in and the brain tells the muscle to contract. The idea, then, is to stretch as far as possible without triggering the stretch reflex. That is, stretching movement should not continue past the point of feeling tension. Every stretch pushes back the point at which the stretch reflex is stimulated. Stretching is effective only when you stretch properly. Stretching can increase one's physical fitness, optimize one's learning, practice and performance of many types of skilled movements, and reduce one's risk of joint sprain and muscle strain. Stretching can also reduce muscular soreness and tension as well as reduce the risk of back problems. To schedule a consultation, call Northville Physical Therapy & Rehabilitation Inc. at 349-3816, or see us at 332 E. Main Street, Suite A. P.S. Stretching also stimulates the production of fluids that lubricate connective-tissue fibers to reduce the friction that causes adhesions. 349-3816 Northville Physical Therapy is conveniently located at 332 E. Main Street, Suite A.

REMEMBER, ONLY YOU CAN PREVENT FOREST FIRES. A Public Service of the USDA Forest Service and Your State Forester.

OPEN HOUSE. Wednesday, January 29th 4:00 p.m. - 7:30 p.m. COME JOIN US! For an evening of fun for your children while parents learn about our incredible child care center. Our owner, director and teachers will be on hand to answer any questions. Kiddie Academy CHILD CARE LEARNING CENTERS 24300 Karim Blvd. - Novi S.W. Corner Grand River & Haggerty (810)426-6789. OPEN FROM 6:30 AM TO 6 PM MONDAY - FRIDAY.

For Quick Results Call GREEN SHEET CLASSIFIED (810) 348-3022 NRRN

Recycle HOMETOWN™

# Visioning session focuses on plans for future of twp.

By RANDY COBLE  
Staff Writer

What kind of a community do we want Northville Township to become? How do we take our town there?

Those were the fundamental questions township decision-makers considered during a special joint meeting last week. Members of the community's various boards, commissions and committees came together on Jan. 16 at the invitation of the new board of trustees.

Elected in November, members of the board called the meeting to discuss a vision for the future and set a tone for their four-year term. Attending were members of the township's planning commission, zoning board of appeals, parks and recreation commission, beautification commission, economic development corporation and insurance committee.

Topping the list of issues for everyone: development.

Dealing with the development of the multitude of vacant land here is unquestionably going to be one of the biggest issues facing Northville Township for decades to come. The question decision-makers tackle everyday is what kind of a community do we want to be?

The answer in the township's case, includes these highlights:

- A largely residential community with a "semi-rural" character, maintained with efforts to save trees and natural open space area.
- Only enough shopping centers to satisfy the needs of township

residents. Try to keep out things that draw crowds from outside of the community, developments like malls or sports stadiums.

• Since businesses pay a lot more property taxes than homes do, having them in town means lower taxes for residents. Keep non-residential areas to a minimum and keep them on the borders of the township where possible.

Transferring those goals from the pages of the township's master plan for land use and zoning ordinances is the tough part.

Our system of law places a lot of stock in the rights of a property owner, and a community has only a limited ability to regulate how an owner gets to develop his or her land.

Striking the balance between the rights of a landowner and a community can be tough. One goal of the meeting was to help outline the parameters within which township decision-makers can work when it comes to development plans.

Another was to set a tone a professionalism early in the new board's tenure.

For example, copies of the township's policies on ethics and sexual harassment were distributed.

Also high on the board's list is improving communications with township residents in general through such devices as Supervisor Karen Woodside's roundtable meeting on Saturday morning with leaders of civic groups and homeowners organizations.



Photo by JOHN HEIDER

## Booming business

A pair of enterprising 13 year olds, Tom Keller (left) and Dan Meyers, work in the bitter cold clearing off some of the recent snowfall along Springfield Drive in Northville Township recently. The pair have an established business in the neighborhood and charge \$10 per property. A recent warming trend couldn't have helped the cause.

# Youth Assistance program seeks volunteers for new course

By LEE SNIDER  
Editor

All that Northville Youth Assistance volunteers need is a caring attitude, and NYA is putting out the call for just those types.

NYA matches community youths with adult mentors who provide friendship and support. The agency is getting ready to start another mentor training course next month, and is urging community members to come forward and join their ranks.

"Only about four people have

signed up so far, but we need substantially more than that to hold the training session," NYA Director Mary Ellen King said. "Almost 100 kids were referred to us last year. The need is increasing."

Most, but not all, of NYA's youths are products of single-parent homes. They get referred to NYA through the police, the courts, the schools and other institutions that think the young people could benefit from adult role model companionship.

The next training session begins

Wednesday, Feb. 26, and runs for five consecutive Wednesdays. The sessions will be taught by counselor Virginia Kennedy at Northville High School, and will take place from 6:30-9:30 p.m.

Upon completion of the course, NYA volunteers are assigned their own youthful companions, and are asked to spend a few hours a week with them.

Mentors and their youths often do simple activities together, like reading, hiking or going bowling. The quality time fills a void in the

youths' lives, and gives the young people a sense of being appreciated by an adult outside of the family.

Commitments run for at least one year.

According to King, NYA has instituted a new program whereby volunteers are sometimes assigned to the parents of NYA children.

"We've got this one single parent who works full-time and attends school - she's overwhelmed by all the responsibilities," King claimed.

"Her volunteer comes into the house and offers support and encouragement, teaches her patience."

King also said volunteers are needed to help on fund-raising and public relations projects for NYA.

Those interested in finding out more about Northville Youth Assistance can call King at 344-1618.

NYA is a joint services, and is funded by both Northville Township and the City of Northville.

## Clarification

An article in the Jan. 16 Northville Record stated, "The (Michigan) Department of Management and Budget handles state land sales and it did not respond to requests for information from The Northville Record." The phrase "before presstime" should have been added to that sentence.

A spokesperson for the Department of Management and Budget did respond to The Record but not in time for her information to be included in the article.

Come on down to the

# MILFORD ICE CARVERS

Spectacular  
1997

Monday thru Sunday  
January 20th-26th  
Celebrate a Winter Weekend

On Main Street in Historic Downtown Milford featuring  
Over 100 Creative Ice Sculptures Carved  
by Professional Carvers

Sanctioned by NICA (National Ice Carvers Association)

**Monday-Thursday**  
Commissioned Ice Sculptures Carved on Main Street

**Friday**  
Commissioned Ice Sculptures Completed  
Hector & Jimmy's "Beach Party"  
Carving Competition On The Patio @ 7:30 pm  
Come down and listen to the band and judge the competition.  
Prizes for best "beach wear" over your long johns!

**Saturday**  
Amateur Carving Contest - 8:30 am  
Professional 2 Man/4 Block Competition  
Cold Buff Euchre Tournament - "A Euchre Tournament On Ice"  
Figure Skating Demonstrations  
Putt Putt On Ice  
Senior Citizens & Handicap Drive-By Tour  
11am 1,000 pound Baked Alaska, sponsored by  
The Appeteaser and "Haagen-Daz"

**Sunday**  
Professional One Man Single Block  
Chili Cookoff at Great American Pizza

Take I-96 to the Milford Exit #155  
North 5 miles to Milford

More Info? Call 685-7129

Sponsored by the Milford Business Association, Huron Valley Chamber of Commerce & HomeTown® Newspapers

# Winter Clearance Sale

Thursday - Friday - Saturday - Sunday  
January 23 - 24 - 25 - 26

Special Sale Hours  
Thursday 10 am - 7 pm  
Friday and Saturday 10 am - 9 pm  
Sunday 11 am - 7 pm

## Huge Savings Up To 75% Off

Incredible savings at over 50 name brand outlet shops!

I-96 at Exit 133 (M-59) • Howell  
Call toll free 888-545-0565

Winter hours through February 28  
Mon - Thurs: 10 am - 7 pm, Fri & Sat: 10 am - 9 pm, Sun: 11 am - 5 pm  
A joint venture between Fru Con Development Corporation and Howard & Rice

**Police News**

# Alleged employee-thief faces court date

A Meijer employee's extracurricular activities got her into hot water with police recently.

The woman, 26, allegedly admitted to systematically bilking the store for more than \$3,000 in cash over the last few months. Store detectives say they caught the woman stealing \$85 in cash on Sunday, Jan. 12.

According to township police the woman, 26 years old and a Detroit resident, admitted to filing credit card refund requests from customers as cash refunds and then pocketing the money. She's been doing it two to three days a week since November. Investigators say she'll face a court hearing on fraud charges soon.

**FRAUD II:** Another Detroit woman was arrested for fraud of a different type at Home Depot last week.

Store employees said the woman, 47, wrote a bad check for an \$89 kitchen cabinet. The cashier allegedly recognized the woman from previous attempts to use bad checks.

When questioned the woman showed fake identification, police said, but eventually admitted to using checks for other people's

closed accounts. The woman, police added, claimed to not know how she got them.

She faces a court hearing on Feb. 5 and was released on bond after being booked. Livonia police are investigating the woman for allegedly passing bad checks at the Target store too.

**SENIOR THIEF:** A Plymouth man allegedly used his wife's purse to steal \$38 worth of goods from Meijer on Jan. 13.

The man, 67, put a variety of items inside the purse, which his wife wore at her back, store detectives said.

Taken were items like tobacco, film and vitamins. The man was booked and released at the scene and faces a court hearing soon.

**BATTERIES NOT INCLUDED:** Employees at The Home Depot saw a man run out of the store carrying a cordless drill and saw on the afternoon of Jan. 15.

The man ran to an older model Ford F-150 pickup, which had two other men inside, and then the vehicle sped away, store employees said. One of them claimed to recognize the man from past returns to the store.

**GENERATOR SWIPED:** Someone stole a portable generator out of a construction trailer on the under-development property near Six Mile and Haggerty during the night of Jan. 14-15.

The generator is valued at \$1,200 and it has been listed as stolen in the law enforcement computer network.

**DRUNK DRIVER:** A Birmingham man was arrested for operating a vehicle while under the influence in the early hours of Sunday morning.

A police officer said he saw the man's 1995 BMW make a left turn from Haggerty onto Six Mile at about 3 a.m.

The BMW was not in the turn lane, the officer said, and swerved as it drove towards the I-275 onramp in Livonia.

When stopped the man, 33, allegedly admitted to drinking at a bar in Birmingham that night. Testing later at police headquarters showed his blood alcohol level to allegedly be .21 percent, more than twice the legal limit of .10 percent.

The man was held until he sobered up, then was released on bail and faces a court hearing

soon.

**JEEP DAMAGED:** Someone tore the plastic window of the door to a 1996 Jeep Wrangler belonging to a Victor Drive man during the evening of Jan. 16.

The Jeep was parked in the man's driveway at the time of the incident. Damage to the vehicle is estimated at \$250.

**MAILBOX SMASHED:** A Waterfall Road man's mailbox was hit by a vehicle of some kind during the morning of Jan. 17, causing it and the post it was sitting on to be demolished.

The man, 62, said the incident must have taken place between 10-11 a.m. that morning. Damage is estimated at \$100.

If you have any information about these or any other illegal incidents you can call Northville city police at 349-1234 or Northville Township police at 349-9400.

# Burglary suspect could do hard time

By RANDY COBLE  
Staff Writer

Northville Township police say a Southfield man led them on a high-speed chase last week after he was caught red-handed burglarizing a home in Blue Heron Pointe.

Investigators say Johnathon Patrick Rose is a professional criminal who's responsible for a string of burglaries all over this area in recent months, including half a dozen in Northville Township. If that's true his career could be sidetracked for several years.

Rose, 27, stands accused of six felony counts of burglary and is also charged with being a habitual criminal, also a felony offense. If convicted he could receive a sentence of life imprisonment.

Three felony convictions already appear on Rose's record, a fact that led to the habitual offender charge, according to township Detective Fred Yankee. Investigators say he's made a habit of

breaking into homes in the township since August.

He usually steals jewelry and little or nothing else from the homes he hits, according to police, and the last one that was his target was a condo in the Blue Heron Pointe complex on Beck Road on the afternoon of Jan. 13.

A Livonia police surveillance team tracking Rose allegedly saw him break into a home there, then come out several minutes later and get into a red Dodge Neon. The car, according to township officers, proceeded southbound on Beck Road and accelerated to speeds of 100 miles an hour as Rose tried to elude police.

He was arrested soon afterwards by Livonia police and was arraigned in 35th District Court on Jan. 16 before Judge Ron Lowe. Rose entered a not guilty plea on Rose's behalf and bond has been set at \$500,000 cash.

Rose remains behind bars awaiting trial.

**BRIGHTON CHRYSLER**  
CHRYSLER Plymouth CHRYSLER JEEP-EAGLE  
Jeep Eagle Dodge Dodge Trucks

## AUTO SHOW SPECTACULAR

**'97 DODGE INTREPID**  
Auto., air, 3.5L, sport package.  
**\$17,999\***  
or **\$191/Mo.**  
Stk. #97440



**'97 DODGE RAM**  
Auto., air, V8, sliding rear window.  
**\$17,188\***  
or **\$119/Mo.**



**'97 PLYMOUTH NEON 4 DOOR**  
Auto., air, cassette, rear defroster.  
**\$11,673\***  
or **\$114/Mo.**  
Stk. #97177



**'97 DODGE CARAVAN**  
Auto., air, 7 pass., V-7, rear defroster.  
**\$16,794\***  
or **\$161/Mo.**  
Stk. #97364



**'97 EAGLE TALON**  
Auto., air, rear def., cassette.  
**\$15,197\***  
or **\$135/Mo.**  
Stk. #97333



**'97 DODGE STRATUS**  
Auto., air, tilt, cruise.  
**\$14,498\***  
or **\$134/Mo.**  
Stk. #97396



**Only 18 Minutes from Ann Arbor!**

\*Plus tax, title & destination. \*\*24 mo. closed-end lease, 12,000 miles per year. 13¢ per mile overage. Option to purchase at lease end determined at lease inception. Monthly payments by 24 for total of payments. Lease price includes 10% of MSRP cash down, destination and acquisition fee. All payments & tax/license fee. First no payment sec deposit. Pretests included where applicable. Subject to credit approval. Payments expire 1/30/97.

**BRIGHTON CHRYSLER**  
CHRYSLER Plymouth PLYMOUTH-DODGE-JEEP-EAGLE  
Jeep Eagle Dodge Dodge Trucks  
9827 E. GRAND RIVER, BRIGHTON  
1-800-DODGE CITY 810-229-4100  
HOURS: MON. & THURS. 9-9, TUES., WED., FRI. 9-6, SAT. 9-3

January 2nd  
**GRAND OPENING**  
ALL WALLPAPER DISCOUNTED 30% OR MORE  
WALLPAPER REMOVAL • SALES  
ONE STOP SHOPPING: WALLPAPER • BORDERS • SUPPLIES  
IN-HOUSE INSTALLERS  
PERSONAL SERVICE FROM EXPERIENCE  
HOURS: M-F 9-6, SAT 10-3  
WE CARRY MOST MAJOR BRANDS  
We Stock Nursery & Juvenile Papers Over 20 Years In The Business!  
**COLBY WALLPAPERING**  
(313) 722-2932  
FAX (313) 722-1774  
2535 S. WAYNE RD. • WESTLAND  
11 Bldg. N. of Nordale Hardware on Det. Michigan Ave. & Cherry Hill

**1996 SPA CLOSEOUT**  
Serious Savings on all '96 Spas. Choose from 25 in stock.

**SAVE \$1000**  
\$6499 Reg. 7499

**SAVE \$1000**  
\$6499 Reg. 7499

**SAVE \$1000**  
\$5299 Reg. 6299

**SAVE \$450**  
\$2499 Reg. 2949

**Coleman & Spas**  
Now you can relax.

Visit our booth (#340) at the Novi Spring Home & Garden Show at the Novi Expo Center Jan. 30th - Feb. 2nd.

**BERKLEY**  
2750 W. 12 Mile Rd.  
398-4577

**POOLS A CO. CO.**  
Family Owned & Operated

**UTICA**  
48270 Van Dyke Highway  
739-5333

Mon., Tues., Thurs., Fri. 11-7  
Sat. 11-4

**You're always in touch with your money.**

**ActionBank On Line Services**  
Now bank anywhere, any time. Pay your bills, transfer funds, and check balances from your personal computer or touch-tone phone. Old Kent's new ActionBank On Line Services make banking easy. It's not rocket science.

**Free 60 Day Trial Offer**  
Find out how to get an ActionBank 60 day free trial offer. Get free checking for 60 days, too. Call or come by your nearest Old Kent office.  
**1-800-OLD KENT**

**OLD KENT**

New or upgraded accounts only. Offer applies to monthly maintenance fees and per debit charges. Service charges, such as NSF and check printing charges, will still apply.

**REMEMBER, ONLY YOU CAN PREVENT FOREST FIRES.**

A Public Service of the USDA Forest Service and Your State Forester.

# Rocky's heats up chili fest, takes home 1st-place honors

## Northville eatery sweeps annual competition

By JAN JEFFRES  
Staff Writer

If you want to stir up a batch of great chili, you've got to roast the red peppers first.

That's the advice from Rocky's of Northville. The eatery holds the distinction of walking away with all three awards - Judges' Choice, Peoples' Choice and Best-dressed Booth - in Novi's annual Chilly Willy Festival Chili Cook-off last weekend.

"It takes roasting to bring out the mild flavor of the peppers. It mellows out the peppers," explained John Campbell, general manager of Rocky's.

A creation of Chef Charles "Rocky" Rachwitz, the "mildly hot" concoction featured beef, papayas (and cantaloupe, served up in a bowl made of bread).

Decorating the booth were a stuffed coyote bagged by Rachwitz in the Yukon, a taxidermy-treated turkey, a Western saddle with silver and assorted cowboy-type accouterments.

"I cannot remember when the same restaurant took all three top awards. Usually the Judges' Choice and Peoples' Choice are different," said Novi Parks and Recreation Supervisor Marilyn Troshak.

Coming in second with the

Judges was Mr. B's, followed by Guernsey's in third place.

Rachwitz spent the entire day prior to the Jan. 18 festival whipping up the delectable six-gallon batch.

"Rocky is a very talented chef. Because of his experience, his expertise in the area, he was able to pull off something different," Campbell explained.

"I think it was something that pleased the mainstream."

Campbell was complimentary about all the chili served up by the competing restaurants, but his palate was particularly impressed by the offering of the Doubletree Hotel's Oak Grill.

While he didn't win any awards, Chef Eric Pietila spent two days cooking up 12 gallons of chili featuring meat from game animals such as those found in the Southwest: wild boar, venison, buffalo, wild duck and rattlesnake. Other ingredients included Juniper-smoked bacon, chocolate, Habernero peppers, Jack Daniels, heaps of fresh herbs, 12 different types of peppers, four types of tomatoes, his own fresh venison consomme and some achiote seed paste.

Pietila said the only meat readily identifiable, by sight at least, was the white-colored servings of rat-

tlesnake.

"I just wanted to make something truly different, typifying the flavor of the west. I try to get the public experiencing wild game," he said.

While Pietila agreed with Campbell that his chili might have been too exotic for the average American, the adults - and kids - lapped up eight gallons of the stuff, enjoying what the chef called "a slow, subtle burn."

Of course, there's more to the Chilly Willy Festival than eating, at least for some people.

Finger-nipping cold made few interested in the Sno-ball Softball Tournament, which ended up getting canceled.

However, with all that good packing snow, the sculpture contest went on.

The Fraser family took first place, followed by the Rhea family. In the Super Score-O, Greg Burkhardt won a family four-pack to a Detroit Vipers game.

First place in the Euchre Tournament went to Tom and John Crutchfield, while second place honors went to Ryan and Scott Pfeiffer.

Each team took home a four-person pass to Waterford Oaks Park's mega-snow slide, "The Fridge."



**Ladies leaping**

Photo by JOHN HEIDER

Instructor Kelly Borcherts (left) leaps into the air along with other Early Dance Class attendees at the Northville Community

Center on Monday. Borcherts and her class of 3- to 5-year-olds learn how to coordinate beginning dance movements.

**OPEN YOUR DOOR TO A HIGH SCHOOL FOREIGN EXCHANGE STUDENT.**

Several countries to choose from, Scandinavian, European, South American, Asian or one of the New Independent States from the former Soviet Union.

August arrival. Call today! Call 1-800-SIBLING today. American Intercultural Student Exchange! A nonprofit tax exempt educational foundation.

**TIMBER CREEK RESTAURANT**

Happy Hour Specials  
Mon-Fri. 4-7 p.m.

Early Bird Specials  
Monday Through Thursday

Tuesday Night Crab Night  
Wednesday Night Prime Rib

18730 Northville Rd., Just @ of 7 Mile Northville • 810/449/6770

**NOTICE OF ADOPTION ORDINANCE NO. 18.563 AMENDMENT TO ZONING ORDINANCE OF THE CITY OF NOVI**

THE CITY OF NOVI ORDAINS:

PART I. That Ordinance No. 84-18, known as the Zoning Ordinance of the City of Novi, is hereby amended by the amending of the Zoning Map as indicated on ZONING MAP NO. 561, attached hereto and made a part of this Ordinance.

PART II. CONFLICTING PROVISIONS REPEALED. Any Ordinance or parts of any Ordinance in conflict with any of the provisions of this Ordinance are hereby repealed.

PART III. WHEN EFFECTIVE. The provisions of this Ordinance are hereby declared to be necessary for the preservation of the public peace, health and safety and is hereby ordered to take effect fifteen (15) days after final enactment. It shall be published within fifteen (15) days of adoption. The effective date of this Ordinance is January 28, 1997.

MADE AND PASSED by the City Council of the City of Novi, Michigan this 13th day of January, 1997. Copies of the Ordinance Amendment may be purchased or inspected at the office of the City Clerk, Novi, Michigan, weekdays between 8:00 a.m. and 5:00 p.m., local time.

KATHLEEN McALLEN, MAYOR  
TONNI BARTHOLOMEW, CLERK

To rezone a part of the NW 1/4 of Section 23, T.1N., R.8E., City of Novi, Oakland County, Michigan, being parcels 22-23-151-012, -017 and -022 more particularly described as follows:

PARCEL 22-23-151-012  
Beginning at a point distant South 1137.46 feet along the west line of Section 23 (nominal C/L of Novi Road) and S70°45'00"E 681.47 feet from the NW corner of Section 23; thence S70°45'00"E 415.24 feet; thence S53°39'00"W 381.18 feet; thence N36°19'00"W 312.40 feet; thence S53°34'00"W 224.82 feet; thence N87°58'32"W 48.24 feet; thence N53°34'00"E 409.04 feet to the point of beginning. Containing 2.24 acres.

PARCEL 22-23-151-017  
Beginning at a point distant South 1137.46 feet along the west line of Section 23 (nominal C/L of Novi Road) and S70°45'00"E 1096.71 feet from the NW corner of Section 23; thence S70°45'00"E 242.38 feet; thence S53°39'00"W 396.82 feet; thence N36°20'30"W 200.00 feet; thence N53°39'30"E 259.83 feet to the point of beginning. Containing 1.40 acres.

PARCEL 22-23-151-022  
Beginning at a point on the easterly right-of-way line of Novi Road, said point being South, 1137.46 feet along the west line of Section 23 (nominal C/L of Novi Road) and S70°45'00"E 63.55 feet from the NW corner of Section 23; thence South 437.67 feet along said easterly right-of-way line; thence S87°58'32"E 254.34 feet; thence N53°34'00"E 409.04 feet; thence N70°45'00"W 617.92 feet to the point of beginning. Containing 3.67 acres.

FROM: I-1 LIGHT INDUSTRIAL DISTRICT  
TO: 1-2 GENERAL INDUSTRIAL DISTRICT  
TC-1 TOWN CENTER-ONE DISTRICT

ORDINANCE NO. 18-563  
CERTIFICATE OF ADOPTION

I, Tonni Bartholomew, Clerk of the City of Novi, do hereby certify that the above Ordinance was approved and adopted by the Council of the City of Novi, at a Regular Meeting thereof, duly called and held on the 13th day of January, 1997, and was ordered to be given publication in the manner prescribed by law.

(1-23-97 NR, NN) TONNI BARTHOLOMEW, CLERK

**It's Girl Scout Cookie Time!**

Call Huron Valley Girl Scout Council  
1-800-49-SCOUT

**BIG DEALS ON BIG TV'S**

**TOSHIBA** 30" Super Tube Color TV. Front surround sound remote control. 700 lines of horizontal resolution. audio video monitor jacks. #CF30F40. **\$599\***

**TOSHIBA** 50" Projection Stereo TV. Dual tuner picture in picture. front surround sound, universal remote control TV-VCR-cablebox, 800 lines of horizontal resolution. audio video monitor jacks. #TP50F60. **\$200 US savings bond from Toshiba. \$200 instant cash-back from Walters.**

**TOSHIBA** 35" Cinema Series Stereo Console TV. Dual tuner picture in picture, Dolby surround sound-with 4 channel DSP, 43 watts total audio output, 800 lines of horizontal resolution, audio video monitor jacks, VCR storage compartment. #CN35F95. **\$200 instant cash-back from Walters.**

**TOSHIBA** 61" Cinema Series Stereo Console TV. Dual tuner picture in picture, Dolby pro-logic surround sound-with 4 channel DSP, 68 watts total audio output, 800 lines of horizontal resolution, audio video monitor jacks. VCR storage compartment. #TP61F90. **\$200 instant cash-back from Walters.**

**ZENITH** 46" Projection Stereo TV. Dual tuner picture in picture, soundtrac volume control, surround sound, 800 lines of horizontal resolution, universal remote control TV-VCR-cablebox plus extra z-trak remote control, audio video monitor jacks. #PVY466SMK. **\$1699\***

**SONY** 32" Trinitron Stereo TV. Front surround sound, universal remote control TV-VCR-cablebox, advanced on screen control system, audio video monitor jacks. #KV32S20. **\$797\***

**GE** 46" Projection Stereo TV. Picture in picture, matrix surround sound, universal remote control TV-VCR-cablebox, audio video monitor jacks. #46GW944. **\$1299\***

**MITSUBISHI** 35" Stereo TV. Picture in picture, surround sound, universal remote control TV-VCR-cablebox, audio video monitor jacks. #CS35307. **\$1399\***

**MITSUBISHI** 40" Picture Tube Stereo TV. Picture in picture, surround sound, universal remote control TV-VCR-cablebox, audio video monitor jacks. #CS40307. **\$2799\***

**MITSUBISHI** 45" Projection Stereo TV. Picture in picture, surround sound, universal remote control TV-VCR-cablebox, audio video monitor jacks. #VS4543. **\$1999\***

**RCA** 32" Color Trak Plus Stereo TV. Very high performance picture tube, universal remote control TV-VCR-cablebox, on screen display, audio video monitor jacks. #F32S25B. **\$647\***

**RCA** 35" Color Trak Plus Stereo TV. Picture in picture, universal remote control TV-VCR-cablebox, on screen display, audio video monitor jacks. #F35F73MB. **\$997\***

**RCA** 52" Home Theatre Projection Stereo TV. Matrix surround sound, universal remote control TV-VCR-cablebox, on screen display, audio video monitor jacks. #F527208A. **\$1799\***

**WALTER'S HOME APPLIANCES**

ALL STORES OPEN DAILY: 10AM - 8:30PM • BRIGHTON & LIVONIA STORES OPEN SUNDAY 12PM-5PM

**Walter's HOME APPLIANCE**

FREE DELIVERY ON MOST MAJOR APPLIANCES WLT 0164-97

<b>BRIGHTON</b> 8180 West Grand River 1/4 Mile north of I-96 (810) 229-5000	<b>CANTON</b> 39915 Michigan Avenue 1/4 Mile east of I-275 (313) 728-9600	<b>DEARBORN</b> 21747 Michigan Avenue 1 Mile west of Southfield (313) 563-1900	<b>LIVONIA</b> 34224 Plymouth 1/2 Mile west of Farmington Rd. (313) 427-7310
--	--	---	---



PAUL FOLINO • 1929-1997

# Plain speaker inspired interest in local government

## Current leaders tell of influence on their lives

By ROBERT JACKSON  
Staff Writer

Chuck Keys had nothing to do one Monday night several years ago.

His wife Mary was preparing to go out for the evening and Chuck was complaining about being bored.

Mary had a solution. "She told me that I should just go to the city council meeting and visit my friend Paul (Folino)," Chuck said.

Keys had met Folino weeks earlier when Chuck and Mary attended a few council meetings to complain about a problem with the local electric company.

"We had been to a few city council meetings to complain about a hole the electric company left when they were digging up cables, and then we returned to complain about the damage to our sod," Mary recalled. "At that meeting Paul told us that he would make a motion to give us what we wanted if we promised to attend more city council meetings."

"He said that being a councilmember was as lonely as being the Maytag repairman," she added. "Looking back on it, that was Paul's way of getting us involved with our community."

Keys ended up taking Mary's advice, and he attended that council meeting instead of sitting in front of the television. The

rest, as they say, is history. Chuck and Paul struck up a strong friendship and Folino kept trying to convince Keys to run for a spot on the city council. Before he knew it, Keys found himself campaigning for office. He was elected as a city councilman in 1993.

"I learned a lot from Paul. He seemed to know everything and everybody. That's the way he was," Keys said. "He really cared about this city and the people who live here."

Parks and Recreation Director Traci Sincoc has a similar story to tell. "Paul has always been recreation's biggest supporter and fan," she said. "He was totally committed to kids and recreation in this community."

Sincoc said that she wouldn't be a member of the local Rotary Club were it not for Folino.

"He was always inviting me to come to the meetings and join Rotary," she said. "He always told me that there was a place for me in the Rotary Club, and finally I agreed to join."

Sincoc will serve as the organization's president next year and she said she plans to dedicate her tenure to Folino's memory. "He brought me into Rotary and that has always been special to me," she said. "What he has done for me and the community means a lot."



Photo by JOHN HEIDER

Hundreds of mourners attended funeral services for the late councilman on Wednesday.

## Ex-councilman described as fighter right to the end

Continued from 1

Paul kept on fighting," Keys said. "That's what he's been all of his life - a fighter. He was that way until the very end."

Born in Northville on Feb. 8, 1929, Folino never strayed from the community he loved. He graduated from Northville High School in 1947 and starred on the football team.

"His favorite high school story was how he played in the inaugural football game under the lights at Ford Field," said Parks and Recreation Director Traci Sincoc. "He was always telling that story. He was proud of the fact that he was one of the first to play at that field."

He started working at Northville Downs when he was 16-years-old, and his first job at the track was as a gate guard. Within a couple years he was an usher and finally a box seat seller, according to Margaret Zayti, Downs executive manager.

"He was with us for 50 years, and there were very few days that he ever missed working," she said.

He and Mamie ran a successful downtown candy store in the late 1950s, and by the late 1960s Folino was operating a successful insurance business in Northville. In 1973 he decided to seek elected office, running for and winning a spot on the city council.

For the next 23 years he not only served on the city council

but he was the president of the Chamber of Commerce, a member of the Parks and Recreation Commission, and a member of the Northville Historical Commission and the city Beautification Commission.

He was also a longtime member of the Northville Rotary Club, the 35th District Council Advisory board, and acted as city council liaison to the Library and Senior Citizens Housing Commissions.

As a Housing Commission member he was instrumental in creating the proposal that led to the development of the senior citizens complex now known as Allen Terrace.

"Paul was deeply committed to this community. He always knew what was going on because he was actively involved," Keys said Saturday. "That is his legacy. He served Northville because he cared about what happened here."

His many years of service and his contributions to the community earned him Citizen of the Year honors in 1993 from the Northville Chamber of Commerce.

"Paul was president and on the chamber board for many years. He made me feel so at home when I first came aboard as the chamber executive director, and he was always a strong and loyal member," said Chamber of Commerce Executive Director Laurie Marrs.

He spent more than 20 years



File photo

Councilman Paul Folino (standing, second from left) outlasted most of his cohorts in terms of service on the city's elective body. Here Folino is seen with his colleagues on the council in a 1982 photograph.

as a city councilman, and according to City Manager Gary Word, Folino embodied the character of Northville and always fought for what he believed was best for the community.

"His heart was always with the community, and regardless of whether you agreed with his point of view or not, you always knew that all he wanted was the best for (Northville)," Word remarked.

Former City Manager Steve Walters, now the city manager of

Plymouth, arrived in Northville at the same time Folino was first elected to the council in 1973.

"I was hired in as city manager in October and the city held its elections in November," Walters remembered. "The thing I recall about Paul is that he always loved Northville and whatever he did on council was for the betterment of the city and its residents."

Walters added that one of Folino's greatest contributions to Northville came after he lost his

election bid for mayor in 1977, and was off the city council for four years.

"At that time he became heavily involved in the chamber of commerce and became the chamber president," Walters said. "That's when he began pushing for the repaving and beautification of Main Street."

"He was very active in the bond campaign and he was always proud of that because he took it as a personal project to better the city."

Folino was reelected to city council in 1981 and served until he was defeated in his second bid for mayor in 1995.

"He approached things from the perspective of having lived in Northville all of his life, and that's a lot different from the loyalty that comes when someone moves into a community and lives there for awhile," Walters added.

"With Paul, there was never any question about it. Northville always came first."

### WHAT THOSE WHO KNEW HIM SAY ABOUT PAUL FOLINO

Paul Folino touched many lives in Northville through his long and active involvement in local affairs. Here's what some community members had to say about the lifelong resident and former councilman:

"Paul will be missed. He was one of those people that embodied the character of Northville. His heart was always with the community, and regardless of whether you agreed with his point of view or not, you always knew that he wanted the best for this community. I always respected him for that." - Gary Word, Northville city manager

"Paul was deeply committed to this community. He always knew what was going on because he was actively involved. That is his legacy. He served Northville because he cared about what happened here." - Chuck Keys, Northville City Council member

"He was a very dedicated person. He always worked hard for the interest of the track, and for the community. He was very proud of the fact that he was a Northville councilman. He loved

this community and that showed in everything he did." - Margaret Zayti, Northville Downs executive manager

"He made me feel so at home when I first came aboard as the chamber executive director, and he has been a strong and loyal member. I will remember his great sense of humor that was always evident in everything he did. He will be greatly missed by everyone." - Laurie Marrs, chamber of commerce executive director

"We'll miss him. Paul was on the Parks and Recreation Commission for many years, and he was committed to kids and recreation in Northville. He was our biggest supporter and fan, and he dedicated a lot of his time and energy to the recreation effort for our communities." - Traci Sincoc, director of Parks and Recreation

"He was a constant, upbeat supporter of what was best for his community. He took great interest in people and you could always depend on him to support a good cause." - State Sen. Robert Geake



Folino was given a plaque for his many years of service after stepping down from the Northville City Council in December 1995.



Marching in the annual Victorian Festival parade.



A high school graduation picture from 1947.

# Donation made in honor of local recipient

By LEE SNIDER  
Editor

Before selling their Main Street home last summer, longtime Northville residents Joe and Mary Keese held a going away sale.

"First, we gave the neighbors what they wanted, then we sold the rest," Joe said. "We sold some of our home furnishings, and moved to Ann Arbor in July."

The sale proved both profitable and worthwhile, as the Keeses later donated \$1,000 of the money they made to the Transplantation Society of Michigan.

Joe said the donation was prompted by his acquaintance with Dr. John Romanik, the former Maybury Sanatorium pediatrician who received a transplanted heart in 1995.

"Our experience with John and Carol (his wife) was wonderful," Joe added. "They're really fine people."

Romanik, who treated TB children at Maybury until the facility closed in 1969, received his new heart in October 1995. Prior to the operation, he was hooked up to a device that provided a continual infusion of intravenous medica-

tion.

He was on and off the transplant list for several years before the call came in that a donor heart was available for him. The organ had belonged to a young physician who lived near Grand Rapids and who died unexpectedly of an aneurysm.

Last year, the Romaniks arranged to meet the family of the donor, traveling to west Michigan to have dinner with them. Romanik said the experience was a highly emotional one.

"It's enough to make a big man cry," he remarked. "I met my donor's wife and three kids. Then

we took a trip out to Arizona to meet his two brothers. I walked up to them ... I couldn't call them anything but 'brother.'"

The names of donors are kept confidential, but the Transplantation Society will act as a contact point between the two parties if the families of both donor and recipient agree to meet. Romanik said he intends to remain in touch with the donor's wife and children.

Since his operation, Dr. Romanik, who is now retired, has been a vocal supporter of the transplantation program. He said there is a crying need for people to

become donors.

"1996 was a dryer year (for donations) nationwide," he said. "You'd think that, with all the publicity surrounding Mickey Mantle and Larry Hagman, donations would have been up. But the need is greater than ever."

Becoming a potential donor is easy. Just call or write to the Transplantation Society of Michigan, 2203 Platt Road, Ann Arbor, MI 48104, phone number 1-800-482-4881. The Society will mail you a simple form to complete and return.

Essential to participating is noti-

"Our experience with John and Carol (his wife) was wonderful. They're really fine people."

-Joe Keese  
former Northville resident

fying a next-of-kin of your intention to donate in the event of untimely death.

## Used book drop-off dates set

Area residents may drop off books and videos for the Friends of the Northville District Library's Feb. 8 and 9 used book sale.

Donations will be accepted from 10 a.m. to noon Saturday, Jan. 25, at the library's loading dock, accessed through the police department's parking lot off Wing Street.

## Brave or crazy, man sleeps outdoors

By RANDY COBLE  
Staff Writer

My, but it's good to know that in this age of creature comforts and there stands a man who laughs in the face of luxury and takes delight in overcoming adversity.

Chuck Totten's one of them. On Saturday night, while most of us huddled indoors and under the covers to escape the cold, he was braving below-zero temperatures in a tent in the backyard of his mother's house on Horton Street in Northville.

Why?

To see if his new sleeping bag, the one he's going to take with him while winter camping, was up to snuff.

"I figured I should try it out here instead of in the woods," Totten, who now lives in Royal Oak, explained.

The evening of Jan. 18-19 sure provided an acid test. Counting the wind chill, the thermometer hit as low as 30 degrees below zero that night.

"My wife thought I was nuts," Totten said. "I just hoped the neighbors didn't think I was crazy."

Chuck's wife, Nancy, declined to take part in the bag trial, which turned out to be a success.

"I was pretty warm," Totten, who hit the rack that night wearing a lot of warm clothing, said.

"It was just the back of my neck that got a little cold."

"I was trying to remember all of the information I've seen about frostbite. I thought we might need it," Chuck's mother, Carolyn, joked.

Let the detractors have their fun. Chuck, who has an avowed dislike of newfangled conveniences like microwave ovens, said he enjoyed getting back to nature for a night - well, sort of.

"Camping is peaceful. You really get to feel the outdoors," Totten explained.

"I heard the police going up and down Eight Mile Road all night long, though" he added.

No cellular contracts,  
no credit checks,  
and no monthly bills.

(Which, in the  
Midwest, could really  
come in handy.)

START THE NEW YEAR WITH AMERITECH PICK UP & GO CELLULAR.

IT KEEPS YOU CONNECTED WHEN YOU NEED IT THE MOST.



Pagers as low  
as \$39 with  
mail-in rebate.



Only from Ameritech Cellular. The one with proven call quality.

For more information on this special offer call 1-800-MOBILE-1, or check our listings to find the location nearest you.

Ameritech

YOUR LINK TO BETTER COMMUNICATION\*

Use of Ameritech Pick Up & Go Cellular service is subject to the terms and conditions provided to you at the point of sale. \$30 minimum in services available. Pick Up & Go Cellular service is non-refundable. Not responsible for loss, theft or unauthorized use of Pick Up & Go Cellular service. Your current address is good for 60 days after your most recent deposit. As long as you use your phone on a pay-as-you-go basis, your phone will remain active. If 2 year minimum pay-as-you-go contract required. Paying after may not be available at all locations. ©1997 Ameritech Corp.

### HIGHEST OVERALL CUSTOMER SATISFACTION AMONG CELLULAR USERS

AVAILABLE ONLY AT YOUR AMERITECH LOCATIONS

- AMERITECH CELLULAR CENTERS
  - Ann Arbor (313) 620-8079
  - Bloomfield Hills (810) 838-1573
  - Brighton (810) 220-4045
  - Dearborn (313) 277-4111 (313) 377-0434
  - Eastpointe (810) 777-0107
  - Farmington Hills (810) 484-8530
  - Flint (810) 733-0061
  - Harbortown (313) 250-5007
  - Lakeside (810) 566-8100
  - Lathrup Village (810) 557-8855
  - Novi (810) 413-1774
  - Plymouth (313) 451-0720
  - Port Huron (810) 385-0280

- Rochester (810) 608-0750
- Royal Oak (810) 549-7000
- Southgate (313) 285-8906
- Troy (810) 588-0780
- Warren (810) 558-5432
- Westland (313) 427-5700
- ABC WAREHOUSE
  - 16 Locations to Serve You
- ADVANCED COMMUNICATIONS
  - Lansing Village, Detroit, Roseville (810) 552-8700
- AIR AMERICA
  - Royal Oak (810) 280-2222
- AIRPAGE COMMUNICATIONS
  - 1 Detroit Area Locations (810) 547-7777
- ALL TIME AUDIO
  - Fairhaven, Farmington, St. Clair (810) 725-6884
- AUTO ADD ON CELLULAR & GLASS CENTERS USA
  - (313) 453-1700

- AUTO ALARM AUTHORITY
  - Detroit Area Locations (313) 242-0370
- AUTO AMERISTAR
  - 8 Locations to Serve You 1-800-217-STAR
- BEEPER EXPRESS
  - 9 Metro Detroit Locations to Serve You (810) 388-9191
- CHAMPION COMMUNICATIONS
  - 1 Locations to Serve You (810) 288-7735
- CYBER-NET TECHNOLOGIES
  - Grand River & E Main (313) 794-3300
- DISCOUNT VIDEO
  - Lake Orion (810) 623-4543
- EXPRESS PAGING
  - Taylor (313) 226-8000
- FINISHING TOUCHES MOTORING
  - Birmingham (810) 647-2236
- GENERAL CELLULAR SALES
  - Rochester Rd., Troy (810) 524-8232
- HAWTHORNE HOME ELECTRONICS AND APPLIANCE
  - Rochester, Birmingham
- HENDERSON GLASS
  - 25 Locations to Serve You 1-800-507-7550
- JEROME DUNCAN FORD
  - Stirling Heights (810) 977-0280

- MEGABYTE COMPUTERS
  - Warren (810) 756-0000
- METROCELL
  - Michigan's Largest Dealer 1-800-LEATHER 1
- METRO 25
  - 1-800-3METRO-25
- MIDWEST AUTOTEL
  - West Bloomfield (810) 960-3737
- MIDWEST ELECTRONICS
  - Call for Location Near You 1-888-4 MIDWEST
- PAGE COM
  - Dearborn (313) 582-0040
- PAGEONE
  - Clinton Twp. (810) 750-0000
- PAGE TEC, INC.
  - 20 Locations to Serve You 1-888-PAGETEC
- PAGE TEL
  - Call for nearest location. 1-888-211-7243
- PAGING PLUS
  - Flint & Oak Park (810) 968-7243
- PALCO ELECTRONICS
  - Southgate/Dorchester (313) 283-1313

- PREMIER CELLULAR
  - Livonia (810) 442-7100
- QUICK PAGE, INC.
  - Warren Hgts., Waterford (810) 414-8888
- RADIO, KNOBS, SPEAKERS & THINGS
  - (810) 838-RINST
- RAPID PAGE, INC.
  - Hazel Park (810) 542-3331
- SKYNET COMMUNICATIONS
  - Clinton Twp., New Baltimore 1-800-SKYNET 9
- SOUND SECURITY
  - Warren, St. Clair Shores (810) 776-7000
- STAR 1 COMMUNICATIONS
  - 4 Metro Detroit Locations 1-800-OK-STAR-1
- STATE COMMUNICATIONS
  - 6 Metro Detroit Locations (313) 511-7777
- TRM GROUP
  - Auburn Hills (810) 377-0400
- U.S. WIRELESS
  - Clinton Township (810) 263-5700
- WOW! COMMUNICATIONS
  - 6 Metro Detroit Locations 1-800-VIR-CALL

\*Ameritech Paging available only at these locations.  
Call 1-800-MOBILE-1

DO NOT ENTER

Great pioneers don't hesitate. MDA research pursues every possible avenue.

MDA®  
Muscular Dystrophy Association

1-800-572-1717

People help MDA... because MDA helps people.



# McCotter not happy over committee assignments

The chairman of the Wayne County Commission has appointed 14 commissioners to various standing and special committees for the 1997-98 legislative term.

And at least two commissioners - both from western Wayne County - aren't happy with Chairman Ricardo Solomon's decision in not returning them to committees.

Thaddeus McCotter, R-Livonia, and Bruce Patterson, R-Canton, criticized Solomon and accused him of playing partisan politics.

"He couldn't stand our anti-tax position and the fact that we're both Republicans," said McCotter, who represents Wayne County Northville and Northville Township.

But Solomon denied he played partisan politics with the positions, claiming that he appointed people based on their interests, dividing the committee positions between the suburban and Detroit representatives.

Solomon had to decide who would serve on eight standing committees out of 15 commissioners. "Inevitably, some people will be disappointed," Solomon said.

"These appointments were not done on a partisan basis. I looked for committees that people were interested in and tried to give representation to all the areas of the county."

"I thought I did a very good job dividing up the appointments between Detroit, downriver and the western suburbs."

McCotter had learned on Jan. 8 that he will not chair the Committee on Economic Development anymore. Instead he will serve as vice chair of that group. Robert Blackwell, D-Detroit, will chair the committee.

McCotter was the only commissioner chairing a standing committee during the last session who was not reappointed as a chairman.

That committee oversees the county-owned property near Five Mile and Sheldon Road in Northville Township that is expected to be developed as a Planned Unit Development. He also was not reappointed to the Committee on Roads, Airports and Public Services.

McCotter believes his position in supporting the Canton Downtown Development in December resulted in his loss of those committee positions.

"I'm convinced that this was the bill due for the DDA. I lost the chairmanship, but I would do it again."

Solomon said he chose to use McCotter to chair a special Legal Affairs committee, a position Solomon said has plenty of responsibility.

"He is an attorney and he will provide an oversight of legal contracts. It is a major responsibility and I hope he will treat it as such. It is an appropriate appointment for him."

Two other Wayne county commissioners - both Democrats - received key positions on standing committees.

Michelle Plawecki, D-Dearborn Heights, will continue as the chair of the Committee on Roads, Airports and Public Services. Kay Beard, D-Westland, was reappointed as vice chair of Ways and Means.

McCotter believes that Solomon wants to run for county executive and is looking for ways to drum up Democrat support by trying to minimize the Republican influence on the commission and on the committees.

"But that won't work," McCotter said. "If anything, it is a testament to Bruce and I of the work we do for western Wayne County."

Patterson was selected to three committees, down from four during his previous term.

"The chairman has the ability to

make these appointments," Patterson said.

"I thought I had a pretty good relationship with the chairman. Judging from the comments he has made at many open and closed meetings."

"It appears to be a partisan power play, and it will affect the residents of western Wayne County."

Out of 15 commissioners, Solomon had to outline 50 appointees to serve on eight standing committees: five seven-member committees and three five-member groups. Except for the chair and

the vice chair, commissioners were appointed to three, four or five committees.

Solomon pointed out that McCotter is on Legislative Research, vice chair of Economic Development, and is on the Committee on Environment, Drains and Sewers.

Patterson sits on Roads, Airports and Public Services; Ways and Means, and is vice chair of Public Safety and Judiciary.

Solomon called McCotter's comment about Solomon possibly running for county executive "out of place."

"My job is to be the chairman and to do the best job I can," Solomon said.

"If you do a comparison of last year and this year, many of the commissioners are on different committees."

"If you look at a committee that has a Detroit chair, there is a suburban vice chair. If you look at a committee that has a suburban chair, there is a Detroit vice chair."

Patterson had hoped for a reappointment to the Committee on Environment, Drains and Sewers, since he has more landfills in his district than other commissioners.

"But that's all right. I'll just work harder," Patterson said.

Committee members have an advantage in getting more detailed information and reports on a timely basis than the commission members who are not committee members, Patterson said.

Plawecki was pleased she retained her chairmanship, but was disappointed because she was removed from Economic Development, and that McCotter was removed from the airport committee and lost his chairmanship of Economic Development.

Plawecki said she would attend

committee meetings, if necessary, for crucial issues. Committee appointments are important for commissioners, Plawecki said.

"It helps you see things before it goes to the committee-of-the-whole. You find out more about it, and you can change your vote at a full board."

In addition to serving as vice chair of Economic Development and as a member of the Environment, Drains and Sewers, and Legislative Research committees, McCotter was also chosen to head up a special committee on legal affairs.



## At Your Metro Detroit Lincoln-Mercury Dealers Big Savings On Versatility & Capability.

**Standard Features:** • 3.0-liter OHC V-6 engine • Dual air bags • Multi-point electronic fuel injection • Front-wheel drive • Tilt steering column • Power rack-and-pinion steering • Rear window washer/wiper • Solar tint glass • Electronic AM/FM stereo cassette • Front cornering lamps • Side window deloggers • Childproof lock on sliding door • GS Preferred Equipment Package 692A: • Power windows/locks • Dual power mirrors • 7-passenger seating • Luggage rack • 8-way power driver's seat • Aluminum wheels • Remote keyless entry • 4 captain's chairs • Rear seat heat/airconditioning controls

**\$279<sup>1</sup>** Or **\$1,000<sup>2</sup> Cash Back**  
On A Purchase Or  
**RED CARPET LEASE**

Per Month, 24-Month Lease

24-Month/24,000-Mile Red Carpet Lease	
First Month's Payment*	\$279
Down Payment	
(Net of Lease Cash Rebate)	\$775
Refundable Security Deposit	\$300
Cash Due at Signing	\$1,354



1997 Mercury Villager GS

\*97 Villager GS with PEP 692A MSRP \$24,195 excluding title, tax and license fee. Lease payments based on average capitalized cost of 89.94% of MSRP for Villager for 24-month closed-end Ford Credit Red Carpet Leases purchased in the Detroit Region through 11/30/96. Some payments higher, some lower. See dealer for payment/terms. Lessee may have option to buy vehicle at lease end at price negotiated with dealer at signing. Lessee responsible for excess wear/tear and mileage over 24,000 at \$15/mile. Credit approval/insurability determined by Ford Credit. Actual security deposit will vary depending on taxes and other fees. For special lease terms and \$1,000 Lease Cash Rebate, take new retail delivery from dealer stock by 4/2/97. Total amount of monthly payments is \$6,696. See dealer for complete details. For \$1,000 cash back on a purchase or Red Carpet Lease of a 1997 Villager, take new retail delivery from dealer stock by 4/2/97. \*Excludes tax and other fees. Always wear your safety belt and seat children in the rear seat.

**Standard Features:** • Dual air bags • 5.0-liter V-8 engine • Sequential multi-point electronic fuel injection • Tilt steering wheel • CFC-free air conditioner • Solar tint glass • 100,000-mile tune-up interval\*\* • Illuminated entry system • 4-wheel disc anti-lock brakes • Preferred Equipment Package 655A: • Anti-theft alarm • Running boards • 6-way power sport bucket seats • Remote keyless entry

**\$349<sup>3</sup>**

Per Month, 24-Month Lease

- All-wheel drive
- Standard V-8
- Running boards

24-Month/24,000-Mile Red Carpet Lease	
First Month's Payment*	\$349
Down Payment	\$1,650
Refundable Security Deposit	\$350
Cash Due at Signing	\$2,349



1997 Mercury Mountaineer

See Your Metro Detroit Lincoln-Mercury Dealer Now.

\*\*97 AWD Mountaineer with PEP 655A MSRP \$31,080 excluding title, taxes and license fee. Lease payments based on average capitalized cost of 90.81% of MSRP for Mountaineer for 24-month closed-end Ford Credit Red Carpet Leases purchased in the Detroit Region through 11/30/96. Some payments higher, some lower. See dealer for payment/terms. Lessee may have option to buy vehicle at lease end at price negotiated with dealer at signing. Lessee responsible for excess wear/tear and mileage over 24,000 at \$15/mile. Credit approval/insurability determined by Ford Credit. Actual security deposits will vary depending on taxes and other fees. For special lease terms, take new retail delivery from dealer stock by 4/2/97. Total amount of monthly payments is \$8,376. See dealer for complete details. \*Excludes tax and other fees. Always wear your safety belt and secure children in the rear seat. \*\*Under normal driving conditions with routine fluid/filter changes.

Visit us on the Internet at <http://www.lincolnm Mercury.com/detroit>

**LIVING VALUES...**

A spring to attain a goal is reaching up. In Girl Scouting, we develop our girls' full potential by encouraging them, often step by step, to accomplish what they set out to do. Small steps to big achievements.

Helping a friend, a neighbor or a member of the community is reaching out. Our young girls turn into responsive and responsible women because we inspire the self-confidence and ethical values that are indispensable in today's world.

Join us and see for yourself the fun, the adventure and growth awaiting you. Call Huron Valley Girl Scout Council today.  
1-800-49-SCOUT





Photo by JOHN HEIDER

Some lucky ticketholder will drive away on this Harley Davidson on May 28. It is on display at Woolly Bully's Restaurant. Owner Mark Roman (left) is joined by Northville Township Police union President Mike Wildt (seated) and Detective Fred Yankee.

### Pride of department to be raffled off

Would like to own a Hog? Want to help out a good cause? If so, make your plans now to get in on a special raffle being put on courtesy of the Northville Township Police Officers Association. The raffle's grand prize is a genuine 1996 Harley-Davidson FLTTP Police Special motorcycle, a vehicle worth tens of thousands of dollars. With the money members of the township police unions will set up a benevolence fund. The fund, according to POA president Michael Wildt, will be used to help the families of police officers should they ever be in need and to support youth activities in Northville. Tickets are \$20 apiece but only 2,500 will be sold. You can buy tickets from any union member or at Woolly Bully's restaurant on Seven Mile Road. The Harley is on display at the eatery now, courtesy of Woolly Bully's owner Mark Roman. The winning ticket will be drawn at Woolly Bully's at 7 p.m. May 28. The bike, which has 3,400 miles on it, was used last year by the township police department for patrol work. The union organization purchased it for the raffle. For more information or for tickets contact Wildt at 349-9400.

### Education Notes

Registration for continuing education classes at Schoolcraft College continues through Feb. 5. Persons registering will find 37 new classes among the 250 offered during the winter semester. Examples of new classes include Internet II - The Great Beyond; How to Achieve Excellent Customer Service; Creative Thinking; Divorce, Taxes and You; Winter Soups and Stews; Jazz Revisited; Dream Interpretation: A Path to Self-Knowledge; Your Two-Year Old; and The Eldercare Connection: Resources for Caregivers. Students ages 60 or older may enroll in classes at reduced rates, with proof of age. As an added service, students may order their textbooks by mail. Simply mail, fax or drop off a duplicate of your class schedule by Jan. 24 and Continuing Education will package and have your books ready for pickup on Jan. 31. For a \$5 fee, your books will be shipped to your home. Persons may register by mail through Jan. 17 by visiting the registration office in the McDowell Center Jan. 27, 28 and 29, or they may register the first week of classes, Feb. 3, 4 and 5 at the registration office. Faxed registrations are accepted any time during this period. Registration forms are available in the winter class schedule. For registration information, call (313) 462-4448. To fax registrations, dial (313) 462-4572.

**Babysitting Skills**  
Learn the skills and secrets of becoming a successful babysitter and resolve to begin your own business in the new year. Schoolcraft College is offering the six-week course, The Babysitter's Club, beginning Feb. 1. Young people who are in the sixth grade or older are eligible for this class which will prepare them to be the babysitter parents choose and children love. Students will learn child care essentials such as feeding, entertaining with a flair and emergency techniques. These include infant and child CPR and first aid. Upon successful completion of the course, students will receive an American Red Cross certification. The course will be held on Saturdays beginning Feb. 1, from 11 a.m. to 1 p.m. The fee is \$65. For registration information, call (313) 462-4448 or fax (313) 462-4572.

## Minimum wage law back before Lansing lawmakers

By TIM RICHARD Staff Writer

Two major labor issues are back before the Michigan Legislature, despite the time lawmakers spent debating them in 1995-96.

First, minimum wage. The House passed an election season hike in the minimum wage, but it died in the Senate Labor Committee, chaired by Mike Rogers, R-Brighton.

Reason: House Bill 4180 hiked the restaurant server's minimum wage, which is pegged at 75 percent of the base minimum, or \$2.52. Business argued that servers, with tips, were making far more than the minimum, and that no hike for servers was necessary.

This year, Sen. Loren Bennett, R-Canton, introduced Senate Bill 1 to raise the minimum wage from \$3.35 to \$5.15 an hour. It would mirror the federal minimum wage change enacted by Congress last year. His bill reportedly didn't touch the server's \$2.52 minimum.

SB 1 was denounced immediately by the National Federation of Independent Business when it went to its first hearing before the Senate Labor Committee last week.

"Most businesses in the state already pay above the minimum wage in order to attract and retain quality workers," said Charles Owens, NFIB state director. "However, small businesses currently exempted under federal law should have the flexibility to determine wage levels that the current Michigan law provides."

"Small business owners believe the marketplace, not the government, should determine the wages and prices of business and commerce."

Federal law doesn't apply to firms with less than \$500,000 in gross receipts that aren't in interstate commerce.

**WORKERS' COMP**  
Second issue is workers' compensation reform.

Last May Rogers got his SB 895, aimed at cutting fraud in workers' compensation, through the Senate on a 21-16 party-line vote, but it died in the House Labor Committee.

Rogers said his bill would halt fraud and "wouldn't cost injured workers a penny."

"If that's all it did," replied Democrat Ken DeBeausaert of Macomb County, "we could come to an agreement." But DeBeausaert said Rogers' SB 895 tried to

overturn two court decisions, rewrite workers comp eligibility standards, retroactively terminate benefits for those paid under the old standard - and generally was rammed through by the GOP majority without giving Democrats time to study the measure.

And so workers' comp is back as an issue.

The Small Business Association of Michigan is making its reform a 1997 legislative priority. "Recent court rulings are threatening to drive costs even higher and drive away employers," said SBAM's Ann Parker, director of government affairs.

SBAM is calling on the Legislature to "end abuses and close loopholes that drive up workers' compensation costs."

She cited several Court of Appeals and Supreme Court rulings that have approved claims for workers who:

- Are able to return to work but who refused to do so because they chose to live in other states.
- Who developed mental problems from ordinary events of employment.

SBAM, with 8,000 members, also said benefit should be calculated on a regular work week, not on overtime or bonuses.

Got an opinion? Write to your state senator, State Capitol, Lansing 48909. If writing about the minimum wage, refer to SB 1. No bill numbers are available yet on workers' compensation.

MESC was created by law in 1936 to administer unemployment benefits and to provide employment counseling. Engler's order transferred the agency from the old Labor Department to the new Jobs Commission.

**Glazed HoneyBaked Turkey Breast** With Any Ham Purchase

**\$14.99**

HoneyBaked® Products score big at SuperBowl parties. Yes, everybody loves the quality, taste and convenience of The HoneyBaked Ham® and Turkeys. Its Good!

Offer valid through March 1, 1997. Coupon cannot be used with any other special offer. Limit one turkey per ham.

Ann Arbor 3446 Washenaw, (313) 677-8500  
Birmingham 31190 Southfield Rd., (810) 540-0404  
Dearborn Hts. 23300 Ford Rd., (313) 274-9600  
Detroit 3741 Fenkel, (313) 862-8622  
East Lansing 2843 E. Grand River, (517) 333-3900  
Flint 3320 Miller Rd., (810) 733-8686  
Grand Rapids 3756 - 28th St. SE, (616) 957-3430  
Livonia 15303 Merriman, (313) 525-2994  
Roseville 29888 Gratiot Ave., (810) 775-7900  
Sterling Hts. 44871 Hayes, (810) 566-4700  
Taylor 23143 Eureka Rd., (313) 374-2600  
Troy 1081 E. Long Lake Rd., (810) 689-4890  
W. Bloomfield 33270 West 14 Mile Rd., (810) 851-2400

## Happy Valentine's Day

The Northville Record

ENTER TO WIN A GREAT VALENTINE'S DAY PACKAGE!

Chocolate Heart Valentine filled with Chocolates courtesy of Sanders Sales Inc.	Massage and Pedicure courtesy of Visions Salon	\$25 Gift Certificate courtesy of Centre Street Market
Perm and Haircut courtesy of Diamond Cuts Salon	Dinner for 2 up to \$50 value courtesy of Rocky's of Northville	1 Dozen Long Stem Roses courtesy of Flowers & More
Hotel Package courtesy of Radisson Suites Hotel Farmington Hills	14 kt Ladies Bracelet w/Pink Hearts \$175 value courtesy of Northville Diamond Jewelers	

MAIL ENTRIES TO NOV NEWS/NORTHVILLE RECORD 104 W. MAIN ST. NORTHVILLE, MI 48167 OR TO DROP OFF AT OFFICE

Name: \_\_\_\_\_  
Address: \_\_\_\_\_  
Phone: Home: \_\_\_\_\_ Work: \_\_\_\_\_

Prizes given by random drawing. HomeTown Newspapers employees/families are not eligible to win prizes. All entries must be received by 5 pm Jan. 31, 1997. Original Entry Blanks only No Photo Copies.

### (Prostate Cancer)

Affects one out of eight men

It's not an easy subject for men to discuss -- but one that can't be ignored. That's why the Providence Cancer Center is pleased to announce the creation of a free monthly informational series to address prostate cancer issues. It is open to prostate cancer survivors and interested family and friends.

"Advances in Prostate Cancer Treatment" will be presented in two sessions, by William McLaughlin, MD, Medical Director, Department of Radiation Oncology at Providence Hospital; and Associate Chairman and faculty member at the University of Michigan.

Thursday, January 30 and Thursday, February 27  
6:30 pm - 8:00 pm

Brass Pointe Restaurant  
Farmington Hills  
(Located at: Northeast corner of Orchard Lake and Ten Mile roads)

To register, please call 810-424-5543

SANDRA BULLOCK CHRIS O'DONNELL

In war they found each other... In each other they found love...

IN LOVE AND WAR

AMC ABBEY 8 STARTS FRIDAY, JANUARY 24 AMC BEL AIR 10  
AMC LAUREL PARK AMC MAPLE 3 AMC SOUTHFIELD CITY AMC SOUTHLAND 4  
AMC STERLING CTR-10 AMC WONDERLAND AMC WOODS 6 GENERAL CINEMAS NOVI TOWN  
SHOWCASE WESTLAND SHOWCASE DEARBORN SHOWCASE PONTIAC SHOWCASE BIRMINGHAM  
SHOWCASE HILLS STAR GRATIOT AT 15 MILE STAR ROCHESTER HILLS WHITE STAR WEST RIVER

www.loveandwar.com • NO PASSES OR COUPONS ACCEPTED

# SUBURBAN FORD DEALERS

## NOW'S A GREAT TIME TO SAVE WHEN YOU LEASE!

NOW LEASE A '97 FORD CONTOUR GL For As Low As

# \$198

First Month's Payment \$198.04  
Refundable Security Deposit \$225.00  
Down Payment (net of RCL cash) \$1725.00  
Customer Cash Due at Signing\* \$2148.04

A MONTH (1) WITH A 24 MONTH LOW MILEAGE (2) RED CARPET LEASE

INCLUDES \$1400 RCL CASH BACK

OPEN SATURDAYS TO SERVE YOU BETTER

Varsity Ford Ann Arbor 3480 Jackson Road (313) 996-2300  
Atchinson Ford Belleville 9800 Ballville Road (313) 697-9161  
Brighton Ford Brighton 8240 W. Grand River (810) 227-1171  
Palmer Ford Chelsea 222 S. Main (313) 475-1301  
Holly Ford Holly 15242 N. Holly (810) 634-4411

Skalnek Ford Lake Orion 941 S. Lapeer (810) 693-6241  
Hines Park Ford Milford 130 S. Milford Road (810) 963-6587  
Arrants Ford Ortonville 968 M-15 (810) 627-3730  
Briarwood Ford Saline 7070 Michigan Ave. (313) 429-5478  
Gene Butman Ford Ypsilanti 2105 Washenaw (313) 482-8581

\*Closed Saturday

**Library Lines**

**LIBRARY HOURS:** The Northville District Library winter/spring hours are Monday-Thursday, 10 a.m.-9 p.m.; Friday-Saturday, 10 a.m.-5 p.m.; Sunday, 1-5 p.m.

For more information, please contact the library at (810) 349-3020 during open hours.

**LIBRARY LOCATION/ADDRESS:** The Northville District Library is located one block south of Main Street and two blocks west of Center. The library's address is: Northville District Library, 212 W. Cady St., Northville, MI 48167-1560.

**LIBRARY BOARD MEETING:** The next meeting of the Northville District Library Board will take place on Thursday, Jan. 23, at 7:30 p.m. in the library's meeting room. Among the items on the agenda is the public evaluation of Northville District Library's Interim Director, Julie Herrin.

The meeting is open to the public and all are welcome to attend.

**TOT STORYTIME:** For 2- and 3-year-olds. Join us for stories and songs. Each child must be accompanied by one adult. There is a limit of 10 children. Registration begins Feb. 10. Sessions run as follows:

Mondays at 11 a.m.: Feb. 24, March 3, and March 10.  
Wednesdays at 11 a.m.: Feb. 26, March 5, and March 12.

**VALENTINE TEA PARTY FOR KIDS:** Join us for the second annual Northville District Library "Tea Party." Enjoy stories, games, crafts, and sweet treats. Designed for children in kindergarten-second grade.

The program will be held on Wednesday, Feb. 5, from 4-5:15 p.m. Registration begins Friday, Jan. 24. Enrollment is limited.

**VALENTINE STAMPING PROGRAM:** Come to the Northville District Library on Tuesday, Feb. 4, from 3-5 p.m. for a fun free program. We'll provide over 50 Valentine's stamps, ink, markers and a limited supply of paper products. Feel free to bring additional stationery from home. All ages are welcome to attend this free program.

**AMERICAN HEART ASSOCIATION PROGRAM:** Come to the Northville District Library and attend a free program sponsored by the American Heart Association. Registered dietitians will present and discuss everyday usage of the guidelines of the American Heart Association program.

This informative program will be given twice on Thursday, Feb. 6, from 3-4 p.m. and 7-8 p.m. The program is free and all are welcome to attend.

**BOOK DISCUSSION GROUP:** Join us at the Northville District Library every second Monday for a book discussion group. Our next program will be on Monday, Feb. 10, beginning at 7 p.m. The featured book is *Praying for Sheetrock* by Melissa Faye Green. The program is free and all are welcome to attend.

**FAMILY COMMUNICATION PROGRAM:** The Northville District Library sponsors a program offered by Hegira, a mental health organization, on Tuesday, Feb. 11, at 7 p.m. The program is "Parenting the Middle School Child." The program is free and all are welcome to attend.

**FRIENDS OF THE NORTHVILLE DISTRICT LIBRARY:** Area residents will have an opportunity to donate books and videos on Saturday, Jan. 25, for the Friends' upcoming used book sale. Friends will be at the library's loading dock from 10 a.m. to noon to accept contributions (receipts will be available). The dock is accessed through the police department's parking lot off Wing Street.

The sale is planned for Saturday and Sunday, Feb. 8 and 9, in the library's meeting room. The Friends do not accept textbooks, encyclopedias or magazines.

Bette Cahill, chair of the Friends' gift book program, recently reported to the group's board of directors that \$1,925 was donated in 1996 to honor and memorialize friends and relatives through the purchase of new books. Since the inception of the program in 1987, \$8,150.43 has been contributed.

The library is seeking volunteers to help shelve and process books on weekdays.

If you can help out sometime between 10 a.m. to 3 p.m., tell Julie Herrin, interim director (810) 349-3026. You don't have to be a Friend with a capital "F" to be a library volunteer.

# Cross country ski trails throughout area offer many winter recreation opportunities

## Maybury among parks with great routes

Looking for a quick winter getaway in southeast Michigan? Try cross-country skiing on more than 60 miles of cross-country ski trails at six Department of Natural Resources State Parks and Recreation areas.

The trails, which provide passage through beautiful scenic landscapes, make a great day or afternoon trip away from the suburbs and the city.

"We have 10 miles of wonderful cross-country skiing on groomed and tracked trails. We're one of the closest ski areas to the metro area," said Jim Nawrot, manager of Ski Venture, Maybury State Park's ski equipment rental com-

pany. "As long as there's snow, we're ready for skiing."

Cross-country skiing is a fun outdoor activity at any state park or recreation area.

Skiers will find a variety of groomed and ungroomed trails, including some along rivers and lakes, at the following southeast Michigan State Parks and Recreation areas:

- Maybury State Park, Northville - Ten miles of easy to difficult groomed trails travel along wooded areas. Ski equipment is available for rent at the warming house, which also features a snack bar and crackling fire in the fireplace. For more information, call (810)

349-8390 or (810) 348-1190.

- Bald Mountain Recreation Area, Lake Orion - Eight miles of easy to difficult groomed trails travel along wooded areas, lakes and streams. For more information, call (810) 693-6767.

- Highland Recreation Area, Milford - Sixteen miles of easy to difficult trails traverse wooded and hilly terrain. For more information, call (810) 685-2433.

- Pinckney Recreation Area, Pinckney - Six miles of easy to difficult trails take skiers along wooded, hilly areas. For more information, call (313) 426-4913.

- Proud Lake Recreation Area, Milford - Twenty miles of easy to

moderate trails through the woods give picturesque views of the river. Ski equipment is available for rent. For more information, call (810) 685-2433.

- Waterloo Recreation Area, Chelsea - Seven miles of easy trails travel through wooded landscapes. Trails are located near the Gerald E. Eddy Geology Center. For more information, call (313) 475-8307 or (313) 475-3170.

A \$20 annual motor vehicle permit or \$4 daily entrance permit is required for entry into any Michigan State Park.

For more information on cross-country skiing or other winter activities, call the Department of Natural Resources Parks and Recreation Division at (517) 373-9900.

# Your information superhighway.



## RESA board recognized

More than 4,200 men and women serve Michigan communities as school board members. This January, as a part of School Board Recognition Month, RESA - the Regional Educational Service Agency - is honoring its five dedicated board members. RESA's board members are elected by school districts in Wayne County.

Among the five elected to a six-year term on the RESA board is Northville Township resident James Petrie, a RESA trustee.

Each year, RESA board members contribute many hours in education-related meetings, setting priorities for budgets and speaking out for the interests of school children.

## Blood drive coming to church

First Presbyterian Church of Northville will conduct a blood drive on Saturday, Feb. 1, from 9 a.m.-3 p.m.

The community needs your help. The Southeastern Michigan Red Cross Blood Services must supply 1,000 pints of blood each day to hospital patients in our five-county area. As of Jan. 10, the lack of available blood has forced some hospitals to cancel surgeries in an

effort to stretch existing supplies.

The main purpose of this blood drive is to replenish the depleted blood supply. Most blood collected by the American Red Cross is processed into several components, so your donation will help three or four patients.

Join the Northville Girl Scouts for this important event. To schedule your appointment, call Julie Johnson at 349-6206.

Your Ameritech Yellow Pages is here. And when you need information fast, Ameritech Yellow Pages is the best place to get it. There's no easier way to find all the information you need. See Page 2 for a list of new shopping features. Check out Ameritech's new Golf Guide, Auto Guide, Internet Guide, and more.

Just think of us as your information superhighway.



YOUR LINK TO BETTER COMMUNICATION®  
Guides available in select Detroit Metro area directories

©1996 Ameritech Corp

**Buying or Selling A Car?**  
**Let the Green Sheet Classified**  
**Give You Auto Assurance!**

## Spring Home & Garden Show

**IDEAS, IDEAS AND MORE IDEAS FROM OVER 300 EXHIBITORS**

Kitchens • Baths • Doors • Windows • Yard/Garden Remodeling • Arts & Crafts • Furniture • Electronics Appliances • Heating & Cooling • Decorative Accessories

**GET A JUMP ON THE HOME IMPROVEMENT SEASON WITH SPECIAL SHOW DISCOUNTS!**

• Garlic Guru Tom Reed presents "Cooking and Better Living with Garlic" and other ideas for using the "stinking rose" as seen on Home & Garden Television.

• BIA's Remodelers Council presents the ABCs of Remodeling seminars

• WXYT's "Ask the Handyman" Glenn Haeg and "Money Talk" Rick Bloom on February 1 & 2

• Treasure Chest contest with daily prizes

• Metropolitan Detroit Landscape Association members' gardens

• Demonstrations on decorating, home repair and remodeling

**SHOW OPENS JANUARY 30TH AT 2:00PM**

Thurs. & Friday 2:00 p.m. - 10:00 p.m.  
Saturday 10:00 a.m. - 10:00 p.m.  
Sunday 10:00 a.m. - 7:00 p.m.

Regular Admission: Adults \$6.00; Seniors \$4.00; Children 6-12 \$3.00; Children under 6 FREE

NOVI EXPO CENTER JAN. 30 - FEB. 2 I-96 AND NOVI ROAD

# Sex offender registry to become law in state

By RANDY COBLE  
Staff Writer

Should you have the right to know if a convicted sex offender is living in your town, on your street, or maybe next door to your house? Public opinion polls show that most but not all people say yes. Wherever you come down on this one, the bottom line is that very soon you'll have that right, courtesy of the state of Michigan.

Gov. John Engler is expected to sign legislation passed by the state legislature last month that will make police lists of convicted sex offenders available to the public. That includes people convicted of everything from child molestation to rape.

The new bill is an amendment to a law passed in 1994 requiring persons convicted of certain felony sex crimes to register their new addresses with the Michigan State Police whenever they move. Both the law and the amendment are modeled after "Megan's Law."

Seven-year-old Megan Kanka was raped and murdered several years ago by a man living next door to her New Jersey home. The offender was a convicted sex offender.

After her death Megan's parents led the fight to get the law which bears her name passed. They say that police and the public should know when sex offenders, many of whom repeat their crimes, move into town.

Gerry Law agrees. Law, R-Plymouth, is the state representative from Michigan's 20th District, which includes Northville Township and the Wayne County section of Northville. He voted for the law in 1994 and the amendment in December.

Also voting in favor of the new bill was Rep. Nancy Cassis, R-Novi, who represents the Oakland County area of Northville.

"People want to know if these people are living next door to them or on their streets or in their neighborhoods where their kids play," Law said. "The statistics are clear that these are not usually isolated incidents. The vast majority of the people who commit these type of crimes do it repeatedly."

That's true, but requiring sex offenders to register isn't the right solution to the problem, says the American Civil Liberties Union. The organization's Michigan branch opposed the law and the

## Genetic material also to be kept on file

By RANDY COBLE  
Staff Writer

Besides their names and addresses, police will soon keep genetic samples of convicted sex offenders on file as well.

Deoxyribonucleic acid, more commonly known as DNA, is the basic building block of life. DNA strands carry all of a person's genetic information and they're just like fingerprints: everyone's DNA is different.

Michigan has had laws on the books about DNA rights since 1990. They require anyone con-

victed of serious felony sex crimes to give a DNA sample to law enforcement officials.

All samples stay on file permanently with the Michigan State Police crime lab in Lansing. Local, county and state police can use the samples to hunt for suspects in criminal cases.

The list of those who have to provide DNA samples will soon grow, Gov. John Engler is expected this week to sign a bill written by Rep. Gerry Law, R-Plymouth, that includes those convicted of kidnapping and murder. That bill

was part of a five-law anti-crime package passed last month by the Michigan Legislature.

Also included in the package was the new law making police lists of convicted sex offenders public. The new DNA sample requirement also extends to juveniles convicted of serious sexual offenses, in addition to kidnapping and murder.

Law wrote the legislation after close consultations with police. The idea is to give the law enforcement community a better chance of catching those who

commit such offenses.

"Many of these people do not get rehabilitated but they do get out of prison. If they commit another crime someday, then police have a better shot at finding the evidence they need to prove it. We've never had that missing link before," Law said.

The American Civil Liberties Union (ACLU) opposed Law's bill.

Creating a national DNA law enforcement databank is an idea now under consideration, Law said, to help track offenders who commit crimes in different states.

amendment. Nationally, the ACLU is waging legal battles in several state and federal courts to have such laws overturned.

The group offers several arguments against forced registration, including:

- Such laws are unconstitutional. The Fifth Amendment says that no one can be punished twice for the same offense. Mandatory registration of someone who's done the time for his crime amounts to "double jeopardy."

John Roberts, executive director of the ACLU's Massachusetts branch, put it this way in a written statement: "Once you do your time your punishment should be over, and this really continues to punish people."

Another opponent of sex offender registration is Melvin L. Watt, a Congressional Democrat from North Carolina who opposed a federal version of Megan's Law in March.

"Its underlying assumption is that once you have committed one crime of this kind, you are presumed guilty for the rest of your life," Watt said.

"That, my friends, is contrary, whether we like it or not, to the constitutional mandates that govern our nation."

• Second, while they sound good the only real effect a law like this will have is to drive those convicted of sex crimes "underground" once they get out of prison. That reduces the chances that they'll try to "go straight" and makes it

harder for police to catch them when they don't.

Michigan state Rep. David Gubow partially agrees. A Democrat from Huntington Woods, Gubow supported the 1994 reg-

istry law but opposed making the list public.

"The idea of registration is a good one. Law enforcement can watch them. But this bill raises the question of whether they

would register or not. It will have a chilling effect," Gubow said. "These people have done their time. They've won the right to go back to society."

• Other ACLU objections include

the possible danger of vigilantism and the fact that even many supporters of the law say it will do little to stop sexual crimes.

Law says that may be true but adds that it isn't the point of the statute.

"We're talking about only those people who've been convicted of serious felony offenses, sexual crimes involving children or force. My argument is that once you're convicted of these horrendous crimes we have to keep track of you," Law said.

If, and when, Engler signs the new bill you can contact the Michigan State Police to review the list of offenders, including their names, addresses and places of residence.

A related legal question is also brewing. So far six states (Michigan is not one of them) have passed "indefinite detention" laws. Those laws not only allow but require law enforcement officials to keep sex offenders who are still considered dangerous behind bars even if they've served their full prison sentences.

## Applications taken for 1997 Art Market

Plans are under way for the 1997 Art Market sponsored by the Northville Arts Commission and held in conjunction with the Northville Victorian Festival.

The 11th annual Art Market will be held Saturday, Sept. 13, from 10 a.m.-7 p.m. and Sunday, Sept. 14, from 11 a.m.-6 p.m. Seventy-five to 100 artists, including creators of fine art and folk art, will be displaying their work.

This juried, outdoor, art fair attracts artists from the entire Midwest area.

Cash prizes of \$500 (first place) and \$250 (second place) will be awarded and some artists will be selected to demonstrate for the public.

Artists interested in obtaining an application for submitting their work for the juried process may call (810) 349-6104.

## Plans for All-Nighter already under way

Northville High school was among the first schools to organize a senior All Night Party, giving seniors a safe alternative for celebrating graduation night.

This year, senior parents are preparing for the party by scheduling committee meetings and starting to plan the decorations. The theme is a secret and will be revealed to the seniors at the graduation breakfast.

Volunteers are still needed along

with donations of materials or money.

Please call Patty Zielinski at 347-4616 or Mary McBride at 348-7104.

Senior parents are urged to send a \$30 payment for a ticket of a night of fun and excitement for their senior child to: Pam Wampler, 44961 Steeple Path, Novi, MI 48375, (810) 344-8847.

The price of the ticket goes up to \$35 after March 1.

# WE, THE BUSINESS OWNERS, IN ORDER TO BECOME BETTER MANAGERS, ACCOUNTANTS, SALESPEOPLE, RECEPTIONISTS, REPAIRMEN AND WHATEVER ELSE WE HAVE TO BE TODAY, DO HEREBY DECLARE OUR RIGHT TO DO ANYTHING WE HAVE TO DO TO STAY IN CONTROL OF OUR BUSINESSES.

## WE, THE HUNTINGTON, SAY "NO PROBLEM."

At Huntington Banks, we believe it's your right to control your business — and your business's money — any way that you want.

That's why we're offering so many ways for you to stay in control. Like business loans, credit lines, cash management solutions and merchant bankcard services. We can even help you import or export products, make tax deposits and set up retirement plans.

It's your business. It's your money. Isn't it time you took control of it? See a Huntington Personal Banker or Business Specialist today.



**Huntington Banks**

Take control of your money.™

## Recycle HOME TOWN Newspapers

# SILVERDOME • NOW THRU SUNDAY

## For the Best Summer of your Life!

# CAMPER TRAVEL RV SHOW

**\$1.00 off!** (one regular adult admission only)

**DAILY SEMINARS**

- 1/22 - Wed. 7pm "Camping in Michigan's Upper Peninsula" - 8pm "Living Alaska"
- 1/23 - Thur. 6pm "Alaska: The RV Way" - 7pm "Preparing for Full-time or Extended Rving" - 8pm "Southwest Adventure" - 1/24 - Fri. 6pm "Understanding Your Automatic Transmission" - 7pm "Camping in Michigan's Upper Peninsula" - 8pm "Living Alaska"
- 1/25 - Sat. 1pm "Southwest Adventure" - 2pm "Camping in Michigan's Upper Peninsula" - 3pm "Preparing for Full-time or Extended Rving" - 4pm "Living Alaska" - 5pm "Camping in Michigan's Upper Peninsula" - 6pm "Understanding Your Automatic Transmission" - 7pm "Alaska: The RV Way" - 8pm "Living Alaska" - 1/26 - Sun. 12:00 noon "Preparing for Full-time or Extended Rving" - 1pm "Alaska: The RV Way" - 3pm "Living Alaska"

**ALL NEW 1997 MODELS**

- 25 of Michigan's finest Dealers!
- The best place to see the top Manufactures' 1997 RVs!
- Exclusive show only prices!
- Great financing!

**"DON'T MISS"**

- The Antique Camper complete with 1916 telescoping apartment, Model T Runabout and historian, David Woodworth.

**SILVERDOME JAN. 22-26**

Discount Coupons Also At:  Presenting Sponsor: 

**SHOW HOURS:**

- WED - FRI. 3:00 - 9:30 PM
- SAT 11:00 AM - 9:30 PM
- SUN 11:00 AM - 6:00 PM



The annual daddy/daughter dance gives everyone the chance to role play.

# Dads and daughters invited to dance night away in town

## Annual rec event set for Feb. 14

By RANDY COBLE  
Staff Writer

Dads, you can probably count on getting at least one dance with your daughter on her wedding day. No guarantees until then, unless you attend next month's daddy/daughter dance, that is.

Yes, it's that time again. Northville's 14th annual daddy/daughter dance will be held Valentine's Day weekend at the Community Center on Main Street, courtesy of the friendly folks at the Parks and Rec department.

The dance is open to fathers and their daughters ages 5-12. The cost is \$15 per couple, \$4 for each additional daughter. You can regis-

ter for the dance by mail using the form found in the Rec Department's winter catalog. In-person registration can be done at the Rec offices in the Community Center, located next door to city hall.

There will actually be two separate dances: the first on Friday, Feb. 14, from 7-9 p.m. and the second from 3-5 p.m. on Saturday, Feb. 15. The deadline for registering for either dance is Feb. 7. Call 349-0203 for more information.

Two sets of daddies and daughters will win dinner out, courtesy of Rocky's of Northville on Seven Mile. The names of Friday night's winners will be drawn at random a day or two beforehand so that they can go to dinner before the dance. Saturday's winners will be selected during the event itself so they can head to Rocky's afterwards.

A disc jockey will be on hand to spin the platters at the dance and a professional photographer will be present as well offering a special deal. Daddies and daughters can have their pictures taken together

and get one five-by-seven copy and four wallet size prints for just \$10. Cookies and punch will be served and Toots the Clown will make the dance too, offering all kinds of entertainment, including face painting.

Hey, wait a minute: what about moms and sons who want to shake a leg?

Don't worry, the Rec department's got you covered with a spring fling hoedown in April.

Open to mothers and sons, ages, prices and registration methods for the hoedown are the same as for the daddy/daughter dance. You must register by April 11 and the dance will be held on Friday, April 18.

Those attending are asked to come dressed in cowboy and cowgirl duds. Toots, the DJ and the photographer, will be at the hoedown. One couple will win dinner for two courtesy of Genitt's, while another couple will win the same courtesy of the Sundowner.

# dignity



Chris Gardner credits the devoted staff at Fairfax Manor "for regaining a quality of life I thought I'd lost forever. I finally found people who really care about my Jack and me."

*Our mission is to provide meaningful experiences and gratification to the residents at Fairfax Manor, and their families, emphasizing the dignity and value of each loved one entrusted to our care.*



Specialists in Alzheimer's and memory loss care.  
1900 Prospect Road, Superior Township, MI

For more information or to receive an application please call 313-483-6662 or fax to 313-483-6663

- Fairfax Manor offers your loved one:
- Personalized Care
  - A Homelike "Family" Environment
  - Activities
  - An Expert Staff
  - Small Group Outings
  - Twenty-seven Acres of Scenic Wooded Countryside
  - No Entrance Fee

# The Northville Record

# SAVE 30%

Subscribe now for only \$18<sup>00\*</sup>

What a great deal! Rush me one year (52 issues) of The NORTHVILLE RECORD for only \$18.00. I save 30% off the street sale price of \$26.00.  
\*Offer good for new subscribers only.  
\*Offer good until May 31, 1997

Name \_\_\_\_\_  
Address \_\_\_\_\_  
City/State/Zip \_\_\_\_\_  
Phone \_\_\_\_\_

Mail to: THE NORTHVILLE RECORD, Circulation, P.O. Box 470, Howell, MI 48844

West Addition  
Open House  
Sunday, February 23

# Welcome To Our New Addition!

"We're proud to announce the newest member of the St. Mary Hospital family."

Our West Addition will open soon featuring a new maternity center, new women's center and new surgical suites!

Our new **Miracle of Life Maternity Center** has been designed for your comfort. Our complete single room private birthing suites with open visiting policy and accommodations for someone to stay overnight, will make your stay feel like home. All with the back-up of a full-service hospital.

Adjacent to the Maternity Center is our new **Marian Women's Center**, providing specialized



health services for women of all ages. Our classes, support groups and diagnostic testing ensure that you receive the best care possible in a friendly, comfortable environment.

Spacious new surgical suites with comfortable family waiting areas and state-of-the-art technology are also housed in the West Addition. A central processing area and support system increases efficiency, saving precious time and resources.

We're committed to providing you with family-centered care, and the West Addition is part of that commitment. That's why **St. Mary Hospital is your hospital.**



**St. Mary Hospital**  
36475 Five Mile Road  
Livonia, MI 48154

Affiliated with William Beaumont Hospital

Physician Referral Service  
1-888-464-WELL

Maternity Center Tours  
(313) 655-3314

Visit St. Mary via Internet  
<http://www.stmaryhospital.org>

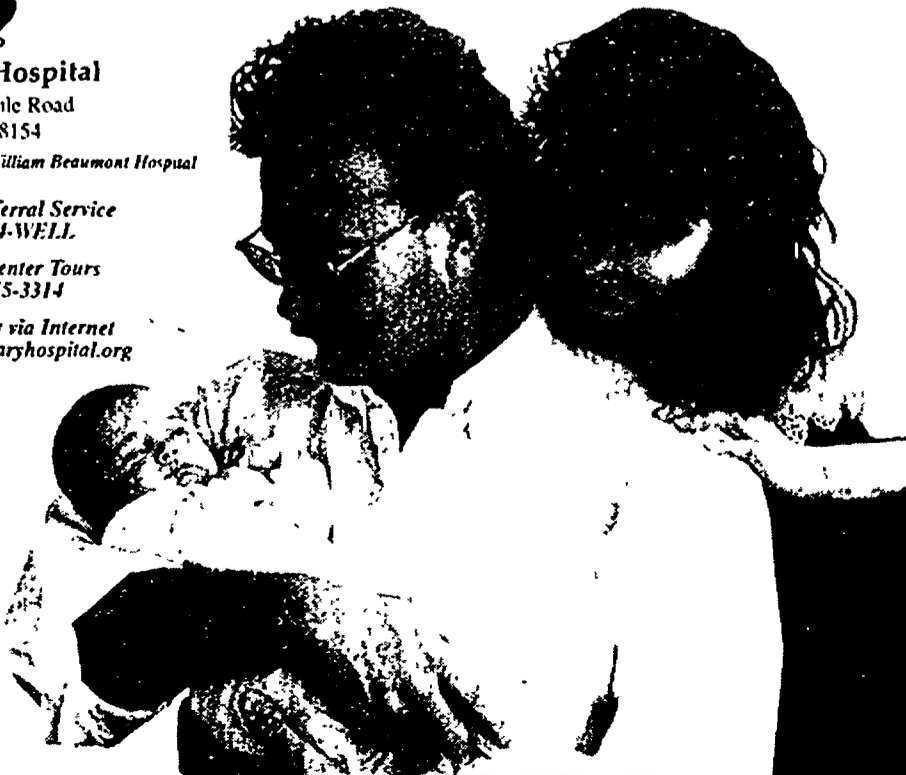

# CLASSIC INTERIORS FURNITURE

## ANNUAL SUPER BOWL SALE!

**SAVE 40% OFF EVERYTHING IN THE STORE!**  
MAKE YOUR PURCHASE OVER \$3,000.00 & **WE'LL PAY YOUR 6% SALES TAX**

**- OR -**  
**2 YEARS INTEREST FREE FINANCING**  
AT REGULAR DISCOUNT SAVINGS

- PENNSYLVANIA HOUSE
- BOB TIMBERLAKE
- KING HICKORY
- HEKMAN
- ATHOL
- SUPERIOR
- RESTONIC
- BUTLER
- SLIGH
- THOMASVILLE
- NICHOLS & STONE
- LEXINGTON
- CONOVER
- HITCHCOCK
- HOWARD MILLER
- I.M. DAVID
- CRAFTMARK
- DINAIRE
- HARDEN
- BRADINGTON-YOUNG
- HOOKER
- CANAL COVER
- STIFFEL
- JASPER CABINET
- CHARLESTON FORGE

# CLASSIC INTERIORS FURNITURE

Mon., Thurs., Fri.  
9:30 - 9  
Tues., Wed., Sat.  
9:30 - 6:30  
Open Sun. 1-5

20292 MIDDLEBELT, LIVONIA  
(South of 8 Mile)

**(810) 474-6900**

• All Discounts Are Off Manufacturers Suggested Retail Prices  
• All Previous Sales Excluded  
• Offer Not Valid in Conjunction With Any Other Promotional Discounts.





**Obituaries**

**LEONARD F. FRITZ**

Leonard F. Fritz died Jan. 16, 1997, at his residence in Northville. He was born March 27, 1922, in Northville to Ambrose and Lillian (Lang) Fritz and was 74 when he died.

Mr. Fritz was a lifelong member of the Northville community. He retired from Northville Post Office in 1982, and was a member of Northville's V.F.W. Post 4012.

He is survived by his daughters, Carol Rowland of Kalamazoo and Jean Fritz of Indiana; son, Leonard of Royal Oak; sisters, Josephine Childers of Wixom and Mrs. Mickey Honsinger of Central Lake; brother, Linwood of Florida; two grandchildren and two great grandchildren.

He was preceded in death by his wife, Helen, in August 1989.

Services were held on Jan. 20 at Casterline Funeral Home with Dr. Douglas W. Vernon, First United Methodist Church of Northville, officiating. Interment was in Glen Eden Memorial Park, Livonia.

**RICHARD A. BUCKLEY**

Richard A. Buckley of Brighton, formerly of Northville, died Dec. 23, 1996, at Sun City West, Ariz. He was 56. Mr. Buckley was born

May 14, 1940, in Northville to the late Allen and Laura (Trufant) Buckley.

Mr. Buckley had been employed at Ford Motor Co. as a manager. In October 1996, he moved from Brighton to Arizona.

He is survived by his wife, Julie (Roberts); daughter, Kimberly Greer of Grand Rapids; sons, Timothy A. Buckley of Brighton, Richard A. Buckley Jr. of Howell, John M. Taylor of Hartland, and Robert Taylor of Brighton; and two grandchildren.

Visitation will be held from 5 to 8 p.m. on Thursday, Jan. 23, at Casterline Funeral Home in Northville.

A memorial service will follow at 8 p.m. with Rev. Lloyd Brasure of Northville officiating. Memorials to the National Kidney Foundation or the American Diabetes Association would be appreciated.

**ROBERT W. CARR**

Robert W. Carr of Novi died Jan. 16, 1997, at St. Joseph Mercy Hospital in Ann Arbor. He was 69. Mr. Carr was born July 17, 1927, in Pinckney, Mich., to Roger and Edith (Smith) Carr.

Mr. Carr moved to the community from Ohio in 1962. He main-

tained several positions at *The Detroit News* before retirement: copy editor, entertainment and column writer. His memberships included The Newspaper Guild and St. Paul's Evangelical Lutheran Church of Northville.

He is survived by his wife, Joyce (Ortendahl); sons, Thomas of Mesick, Daniel and Steven of Ypsilanti; daughter, Cynthia Ward of Ypsilanti; and five grandchildren.

Services were held on Monday, Jan. 20, at St. Paul's Lutheran Church with Pastor Lawrence Kinne officiating. Interment was in Pinckney Cemetery.

Arrangements were made by Casterline Funeral Home in Northville.

Memorial contributions to St. Paul's Lutheran Church, 201 Elm St., Northville, MI 48167 would be appreciated by the family.

**ROBERT L. JAMESON**

Robert L. Jameson of Northville died Jan. 9, 1997, in St. Mary Hospital, Livonia, Mich. He was 74. Mr. Jameson was born June 20, 1922, in Woodward, Okla., to Frank and Opal (Sivers) Jameson.

Mr. Jameson was a retired sales representative. He was a member of the First Presbyterian Church of

Northville and Northville's Masonic Lodge No. 186.

His survivors are his sons, Jamie of Beverly Hills, John of Northville, and Richard of East Lansing; brother, John of Kansas; six grandchildren and two great grandchildren.

He was preceded in death by his wife, Frances, in December 1984.

Services were held on Monday, Jan. 13, at Casterline Funeral Home with Rev. Kent Clise and Rev. James Russell, First Presbyterian Church, officiating. Interment was in Rural Hill Cemetery in Northville.

Memorials to the Michigan Wildlife Foundation would be appreciated.

**MARY P. SULLIVAN**

Mary P. Sullivan died Jan. 19, 1997, in Sarasota, Fla. Miss Sullivan was 92. She was born March 15, 1904, in Sydney Mines, Canada, to John and Sarah (MacNeal) Sullivan.

Miss Sullivan was a resident of the area until 1981, when she moved to Sarasota, Fla. She retired in 1977 as the office manager with G.A. Brown & Associates, which was a manufacturer's representative for the J.P. Stevens Co. She worked for 24 years before her retirement. She was a member of the Women's City Club in Sarasota, Fla., and the Pi Omicron National Sorority.

Surviving Miss Sullivan are her brother, Patrick E. of Hobe Sound, Fla.; sisters, Cecelia Staffan of Livonia and Veronica Rose of Northville; and nieces and nephews.

She was preceded in death by two sisters, Patricia Gugel and Hildegard Forsythe; and by five brothers, Augustus, William, Thomas, Frederick and Richard.

A 10:30 a.m. mass will be held Thursday, Jan. 23, in Holy Family Catholic Church in Novi. Father John Budde will officiate. Interment will take place in Holy Sepulchre Cemetery in Southfield.

Memorial contributions to a charity of choice in memory of Miss Sullivan would be appreciated.

**EDNA L. DOWNER**

Edna L. Downer formerly of Northville, died Friday, Jan. 17, in Charlotte, Mich. She was 85. Mrs. Downer was born Aug. 12, 1911, in Ovid, Mich., to Anthony S. and Lucy (Morse) Jorae.

Mrs. Downer graduated from Ovid High School in 1927, and completed County Normal School in Ypsilanti. She taught school in Chelsea, Manchester, and Wayne County rural schools. Mrs. Downer was a member of Northville United Methodist Church.

She is survived by her daughters Jean Knauff of Charlotte and Ann Muir of Kingston, Ontario, Canada; her sister-in-law, Mildred Jorae of Ovid; her five grandchildren and one great grandchild.

She was preceded in death by her husband, Gael L., in 1988.

**Do you have any of these symptoms?**

- Loud snoring
- Insomnia
- Leg jerks while sleeping
- Breathing pauses during sleep
- Excessive daytime sleepiness
- Irritability and mood swings

The Michigan Institute for Sleep Medicine, affiliated with Providence Hospital, addresses the needs of patients who suffer from one of the above symptoms or the more than 88 officially recognized sleep disorders. If a sleep problem is keeping you or someone you know from a more productive life, call 1-800-547-8421 to schedule an appointment with one of our sleep specialists.

- William T. Allen, MD, Diplomate, American Board of Sleep Medicine
- Timothy Hsu, MD, Diplomate, American Board of Sleep Medicine

**MICHIGAN INSTITUTE FOR SLEEP MEDICINE**

Providence Medical Center - Providence Park  
Sleep Disorders Center  
47601 Grand River Avenue  
Novi, Michigan 48374  
810-380-4290

Providence Medical Office Building  
22250 Providence Dr., Suite 100  
Southfield, Michigan 48075  
1-800-547-8421

McPherson Hospital  
McPherson Medical Offices  
620 Byron Road  
Howell, Michigan 48843  
1-800-547-8421

St. Joseph Mercy Hospital  
5305 Building, Suite 306  
5301 East Huron River Drive  
Ann Arbor, Michigan 48106  
313-712-2128

**MAPLES of Novi**  
Seafood Tavern & Grill  
Starting January 14 through March 27, 1997  
BACK BY POPULAR DEMAND

<p><b>EVERY TUESDAY:</b> ALL YOU CAN EAT <b>CRAB FEST AT THE MAPLES</b></p> <p>Includes A.Y.C.E.: Juicy Snow Crab, Redskin Potatoes, Corn on the Cob, Salad &amp; Bread Basket, Hot Drawn Butter</p> <p>All For Only <b>\$14<sup>50</sup></b></p>	<p><b>EVERY WEDNESDAY:</b> ALL YOU CAN EAT <b>PASTA NITE AT THE MAPLES</b></p> <p>"The Pastabilities are Amazing." Join chef Matt Jagusch and the Maples staff for a variety of pasta selection. Every Wednesday. Includes: Your choice of a Pasta Entree, Fresh Garden Salad, Hot Bread Basket, A Fresh Grated Parmesan Cheese at your table.</p> <p>All For Only <b>\$6<sup>95</sup></b></p>	<p><b>EVERY THURSDAY:</b> ALL YOU CAN EAT <b>TENDER BABY BACK SPARE RIBS</b></p> <p>Enjoy A.Y.C.E. Juicy, fallin' off the bone slow roasted baby back spare ribs, cooked with chef Matt's special BBQ sauce and grilled on an open flame. Includes: French Fries, Creamy Cole Slaw, Fresh Bread Basket and all you can handle BBQ sauce.</p> <p>Only <b>\$12<sup>95</sup></b></p>
---	--	---

**810-669-6551**  
31260 Wakefield Dr.  
On 14 Mile Rd.  
1 Mile West of Haggerty  
3/4 Mile East of Decker

**Bavarian Village**

**SKI & SKIWEAR**

**CLEARANCE**

**STOREWIDE**

**25 to 40% OFF** Retail Prices

Clearance Savings On Selected Jackets, Pants, Suits, Shells, Sweaters, Fleece Tops, Fleece Bottoms, Bibs, Underwear, Hats, Gloves, Socks, Sunglasses, Goggles, Stretch Pants, Skis, Boots, After Ski Boots, Bindings, Mittens, Poles, Cross Country, Snowboards, Snowboard Clothing, and More...

**CLEARANCE SAVINGS IN EVERY DEPT**

**SHOP TODAY FOR BEST SELECTION**

**Bavarian Village** Intermediate Markdowns May Have Been Taken

**INTERNATIONAL SKI & GOLF**

• BIRMINGHAM HILLS 2510 WOODWARD in Square Lake Rd 310-327-3333	• BIRMINGHAM 9110 TOWNSEND in Corner of Parkway 313-826-9300	• FARMINGTON HILLS 1711 ORCHARD LAKE RD #112 MAIL 313-973-9300	• MT CLEMENS 1115 S GRATON 1/2 mile N. of I-24 Rd 317-327-9696	• DEARBORN HEIGHTS 2011 FORD RD 1/2 mile W. of I-24 Rd 810-632-1199	• FLINT 4201 MILLER RD at W. from General Motors Mall 416-941-1999	• CATER TOLL FREE 800-547-8421
• NOVI 11000 WOODWARD in Square Lake Rd 313-826-9300	• GROSSE POINTE 11150 WASHINGTON in North of I-24 Rd 313-973-9300	• ANN ARBOR 214 E SAGINAW in Ann Arbor 517-327-9696	• EAST LANSING 2015 2nd Street S.E. at Bosc & Kalamazoo 810-632-1199	• GRAND RAPIDS 1115 E FROST ST in Grand Rapids 416-941-1999	• TRAVERSE CITY 1115 E FROST ST in Grand Rapids 416-941-1999	• SUGAR LOAF 1115 E FROST ST in Grand Rapids 416-941-1999

OPEN DAILY 10-9 • SATURDAY 10-6 • SUNDAY 12-5 • VISA • MASTERCARD • DISCOVER • AMERICAN EXPRESS • DINERS

**We Always Have Great Rates On Certificate Accounts!**

**6.50%**  
Annual Percentage Yield

2 Year Term Minimum Balance of \$1,000

Also Available for IRA Deposits as Low as \$500

**Compare & Save!**  
Unlike area banks, Community Federal consistently offers high rates on Certificate Accounts. Call today and discover the credit union difference.

**Community Federal CREDIT UNION**

**Plymouth** 313 453-1200

**Canton** 313 455-0400

**Northville/Novi** 810 348-2920

Annual Percentage Yield is effective January 1, 1997 and is subject to change. A penalty will be imposed for early withdrawal. Accounts federally insured to \$100,000 by the NCUA, an agency of the U.S. Government.

# King's beliefs evoked at event

Continued from 1

A Community Organization Recognizing Diversity (ACORD) held its fourth annual Martin Luther King Jr. walk this week on the day set aside each year to observe the birthday of the slain civil rights leader. It was a gesture to recall and reflect.

Despite a plunging thermometer, more than 300 people took part in the walk, which began at Northville City Hall and ended at the First Presbyterian Church.

The walk, silent and candlelit, was symbolic. Black and white, young and old, strode down Main Street, their only sounds the crunching of snow and ice underfoot. One couple could be seen pulling their small children, bundled up against the cold, along on the walk in a little red wagon.

Passersby on foot and in cars coming upon the scene would pause a moment, taking in the long line of quiet marchers, before going on their way. Inside the church, marchers gathered in a circle, the light from candles and flashlights playing on ceiling as songs like "God Bless America" and "We Shall Overcome" were sung.

Special guests at this year's walk were members of the musical group The Voices of Corrections, a choir composed of employees of the Michigan Department of Corrections. Some members of the group work at the Scott Correctional Facility on Five Mile in Northville Township.

As always, members of Northville High School's choir, led by Mary Kay Pryce, lent their voices to the walk, and sang verses of some songs in Swahili and Zulu.

The evening ended with Northville Mayor Chris Johnson reading words spoken by King shortly before he was killed in 1968. Don't mention my awards, King said.

"That's not important," he continued. "I'd like for somebody to say that Martin Luther King Jr. tried to love somebody. I want you to be able to say that I did try to feed the hungry."

"I want you to be able to say that I did try in my life to clothe the naked."

"I want you to say on that day that I did try in my life to visit those who were in prison and I want you to say that I tried to love and serve humanity."



Community members and students walked from Northville City Hall to the First Presbyterian Church Monday to participate in Martin Luther King Jr. activities.

# ACORD agenda promotes diversity

A Community Organization Recognizing Diversity (ACORD) is composed of Northville residents who are concerned with fostering harmony and understanding diversity.

Here's a quote from its mission statement: "We believe in actively promoting equality for all people regardless of race, creed, color, religion, gender, disability, socioeconomic situation or national origin."

"We have come together to appreciate our similarities and differences; develop educational programs to increase awareness; and act as a resource for the community and schools."

ACORD meets at Northville High School in Room 130 on the second Tuesday of every month. The meetings begin at 7 p.m. The high school is off Center Street near Eight Mile Road.

Here's a rundown of the topics that are planned for future meetings:

- Feb. 11: Dr. Steven Anderson presents a talk on parental involvement and its affect on student achievement.
  - March 11: Women's history month, which will include a new discussion of last year's dialogue on racism.
  - April 8: ACORD's annual meeting and election of officers.
  - May 13: International/multi-cultural festival for children and their parents (location to be announced).
  - June: Board meeting only.
  - July: Fourth of July parade (with ACORD float and T-shirts).
  - Aug. 12: Planning meeting.
- For more information call ACORD chairperson Al Qualman at 349-1343.

# Holiday designation for civil rights leader dates back to 1983

By RANDY COBLE  
Staff Writer

The Rev. Dr. Martin Luther King Jr. was born on Jan. 15, 1929, in Atlanta, Ga., the son of a preacher. He skipped the ninth and 12th grades and enrolled in Atlanta's Morehouse College at the age of 15.

King decided to become a minister and was ordained just before he graduated in 1948. The preacher became a Ph.D. in 1955, picking up a doctorate in theology from Boston University. It was there

that King met music student Coretta Scott, whom he married in 1953 and with whom he would have four children.

King became pastor of a Montgomery, Ala., church in 1954, the year before Rosa Parks refused to give up her seat on a city bus to a white man. The young minister led a 12-month boycott of Montgomery's bus system to protest its segregation policy, calling for non-violent civil disobedience.

"First and foremost we are American citizens," he said. "We

are not here advocating violence. The only weapon that we have is the weapon of protest. The great glory of American democracy is the right to protest for right."

King became one of the leaders of the movement fighting segregation in public schools, transportation and facilities like restaurants and motels.

In 1957, he helped found the Southern Christian Leadership Conference, an organization that played a key role in the battle.

He survived the bombing of his

home, a time in jail and attacks from counter-demonstrators and law enforcement officials. The protests brought about major revisions and expansions of civil rights laws in the 1960s. King himself received the Nobel Peace Prize in 1964.

Beginning in 1966, he began to focus on poverty, calling it a cause of racism, and set his sights on a "poor people's campaign" that aimed at diminishing or eliminating poverty through societal and governmental action.

On April 4, 1968, while in Memphis, Tenn., to support striking black garbage men, King was shot dead outside his motel room. Riots erupted in more than 100 cities that spring and summer.

James Earl Ray, an escaped convict, was convicted of the murder but many still believe he did not act alone.

In 1980, King's Atlanta home, church and gravesite were designated as national historical sites. In 1983 Congress passed a law making his birthday a holiday.

# Arts Commission lecture to focus on American Impressionist Whistler

The second in a series of three Michael Farrell art lectures hosted by the Northville Arts Commission, originally scheduled for Feb. 11, has been canceled and will be rescheduled for presentation on March 18.

The lecture features James Abbott McNeil Whistler.

Born in New England, Whistler failed to graduate from West Point and moved to Paris where he exhibited at the Salon des Refuses with Manet, who had a profound

influence on him.

The third lecture, originally scheduled for March 18, which features Mary Cassatt, will be presented on April 8. Born in Philadelphia, she attended the Pennsylvania Academy of Art and

continued her studies in Paris. She remained in France for the rest of her life. She had a profound influence on the acceptance of Impressionism in America and was a longtime friend of Degas.

Tickets are \$9 each at the door.

Special student prices are also available. The lectures will be held in the Forum at Northville High School, 775 N. Center St., Northville and will begin at 7:30 p.m. For further information please call (810) 349-6104.

**FARRELL SERIES**

- Date: March 18.
- Topic: James Abbott McNeil Whistler.
- Where: Northville High School.
- Cost: \$9 at the door.

**PRE-SEASON SALE** SEARS HOME IMPROVEMENTS

**30% OFF SELECTED 30 YEAR SHINGLES**  
Selected styles. Installation and accessories sold at regular price. **ROOF REPAIR**

**10% OFF INSTALLED GUTTER SYSTEMS**  
Selected styles. Accessories sold at regular price. **No Money Down and No Payment Until May 1997!**

**15% OFF INSTALLED GARAGE DOORS**  
CHOOSE FROM A VARIETY OF WINDOW OPTIONS. Single and Double Doors Available. Selected styles. Accessories sold at regular price.

**50% OFF SELECTED CHAIN LINK FENCING FABRIC**  
Selected styles. When you purchase accessories, gates and installation at regular price. **WOOD FENCING Also Available**

**HURRY, OFFERS END 1/25/97**  
CALL FOR A FREE IN-HOME ESTIMATE  
**1 800 224-2241 Ext. 1001**  
Proudly Sold, Furnished and Installed by Diamond Exteriors, Inc., a SEARS Authorized Contractor

\*Ask Sales Representative for details. \*No monthly payments until May 1997 on SEARS Deferred Credit Option. You must request this option. Finance charges accrue from the date of purchase. Ask Sales Representative for details. Minimum repair charge applies. License No. A2: 19645; CA: 673760; CT: 545602; FL: CC0051571; NC: 0208112; CO: 0257201; KS: 021811; IL: 115465; MD: 149424586A; NY: 30119; OH: 01189-20170; NY: 118C1780000; 21,439-HR, 902975; WI: 5462-HB3; OR: 82638; PE: 111177; TN: H01514; VA: 2705-021271A; WA: DIAMOE1077NS; WY: 023758.

**FURNITURE & APPLIANCE**

**SEARS OUTLET**

**20-60% OFF**

original retail prices!

**washers  
dryers  
ranges  
refrigerators  
sofas  
recliners  
mattresses  
and more!**

One-of-a-kind, out of carton, discontinued, floor samples, dented, scratched and reconditioned merchandise. Items pictured are just a few examples of the hundreds of great values. Merchandise shown is representative only. Actual merchandise varies by store.

**SEARS WAREHOUSE OUTLET**  
12001 SEARS AVE.  
LIVONIA  
1 MILE WEST OF MIDDLEBELT  
OFF PLYMOUTH RD.  
PHONE: 422-5700  
Now more ways to buy at Sears

Map showing location: MERIMAN RD., C & ORR, SEARS AVE., PLYMOUTH RD., MIDDLE BELT RD.

**PREVIOUSLY SELECTED MERCHANDISE NOT INCLUDED**

**NEW SHIPMENTS ARRIVING DAILY!**

**Open 7 Days**  
Mon. & Fri. 9:30 a.m. - 9:00 p.m.  
Tues., Wed., Thurs. & Sat. 9:30 a.m. - 6:00 p.m.  
Sunday 12:00 Noon to 5:00 p.m.



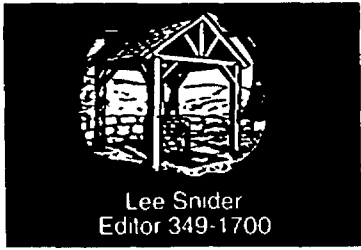

## Our Opinion

### Smooth start bodes well for new township board

If the signs we're seeing now hold any portent for the future, people in Northville Township are on the road to seeing a smooth, well-run local government thanks to their new board of trustees.

They've been in office about two months and so far the seven members of the board have shown a commitment to setting the right tone from the get-go. They seem determined to end the fragmentation seen in the township in past years, to restore the township's oft-damaged reputation for professionalism and to craft a vision of what they want to do during their four years in office.

That's exactly what's needed, for several reasons.

In the first place, for a board to function its members must be able to trust each other. That's different from unity. Unity on every issue is not realistic or even desirable. Trust is about playing like a team that has honesty and respect despite individual differences.

Second, if trust is necessary for a good board, then a good board is necessary for good government.

A good board selects good administrators to oversee the day-to-day services that the township provides its residents, like police patrols and garbage pickup. It presents a strong, professional, unified front to developers and other units of government that come to town wanting things from us.

It also makes a real effort to get ordinary citizens involved in the decisions

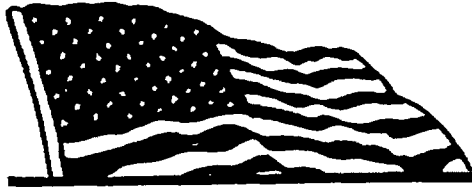

## Government

that are going to affect their lives. A good board that does that inspires trust. That trust is needed to get the millages passed that pay for the things which affect our quality of life, everything from fire trucks to new soccer fields.

Mixed in there somewhere in a good board is solid planning for the future. The township is not static. New businesses and new people are moving in all the time.

Managing that growth is not just a task for today but for next year and the next decade as well.

How many police officers are we going to need five years from now? Where can we build the parks for the kids of people who move in here 10 years down the road? These are just some of the questions about the future that face our local elected officials, all while they're juggling the ones that come up today.

So far the new board has made strides in all of these areas. If the trustees maintain it citizens of Northville Township will be the beneficiaries.

### The toughest volunteer position in a community

It might sound trite, if not hypocritical, for a newspaper that often criticizes public education to put in a plug for School Board Recognition Month, celebrated during January across the country.

But, as fond as we are of playing Monday morning quarterback with their decisions, we really do appreciate the dedication and difficulty involved in serving as a board of education trustee.

The position's especially tough in a district like Northville, where the very success of the education program seems to put parents in a mood to demand even more from everyone involved in the process.

There must be a lot of emotional and intellectual satisfaction in serving on a board of education, because there sure are a lot of hassles to compensate for. Board members put in countless hours keeping up with the issues and with the evolving ideas in education. In addition to attending meetings of committees, subcommittees, and full boards.



## Education

There are intransigent union negotiators, difficult teachers, know-it-all administrators, and undisciplined students to contend with. Not to mention a sometimes hostile press.

But the greatest challenge must be the parents themselves, many of whom simply refuse to believe that any fault might lie with their own child-rearing methods or with their model-behavior kids.

One can only imagine the bursts of emotion board members must be forced to listen to.

It's a tough job, but somebody's got to do it. Thankfully, somebody does.

### Thompson's zealousness wasted public resources

Words like "mean spirited" and "vindictive" are used a lot in politics. They were used especially often to describe Richard Thompson, who was Oakland County Prosecutor from 1988-96.

Those words were precisely defined in the last two weeks.

• Last week, the new prosecutor, announced he would dismiss all proceedings against Dr. Jack Kevorkian, the retired West Bloomfield pathologist who has assisted in 40 or so suicides.

Thompson had tried Kevorkian several times, but no jury had been willing to convict him. That should have sent Thompson a message, but it didn't. Thompson continued to beat his head - and the public check book - against a brick wall.

Gorcyca reviewed charges in 10 cases pending against Kevorkian and decided Jan. 11 they had been "written in haste" and "without full investigation."

Gorcyca's telling point was that there was a "low probability of conviction." Essentially, he decided it was unwise to continue hounding Kevorkian, as Thompson had done, regardless of

one's moral beliefs about suicide. Meanwhile, the U.S. Supreme Court is taking up the issue of physician assisted suicide.

• The Michigan Supreme Court slapped down Thompson in an appeal of a bad Southfield police arrest.

"A hunch is not sufficient to give rise to reasonable suspicion," Justice Charles Levin wrote.

• Thompson lost an appeal in his case against Teressa Nix, whom he wanted to charge with murder.

Justice Michael Cavanagh found Thompson attempting "revisionist history of the principles underlying the double jeopardy clause ..." against Nix.

Some would argue Thompson was just "tough." Some would even call him "conservative."

It is neither tough nor conservative to hound defendants with repeated charges, disregard the Bill of Rights, throw fiscal caution to the wind, and refuse to take "no" for an answer from the courts. It is mean-spirited.

It appears the new prosecutor, Dave Gorcyca, knows the difference. We urge him to remember it.

### Folino always put Northville first

For Paul Folino there was only Northville.

It was a little over a year ago when I sat in Paul and Mamie Folino's living room. Paul had just lost his bid for mayor in the November election and he had invited me over for one of Mamie's famous pasta dinners and conversation.



Robert Jackson

So there I was, sitting comfortably in an easy chair listening to Paul talk about Northville's past like it had just happened yesterday. I waited awhile and then I posed a question I had been wanting to ask him for several weeks.

"Paul, you have spent the better part of three decades involving yourself with everything that has gone on in this city. Now that you're no longer on the council, what are you going to do with yourself?"

He paused for a second then smiled. "Bob," he said, "I think I'm just going to relax."

Without missing a beat Mamie let out a laugh from the kitchen. "Paul, you've never relaxed one day in your life."

I turned back to Paul, waiting for his reply. My gaze was met by that big broad smile, and a mischievous gleam in his eye. "She's right you know," he said with a chuckle.

Sure enough, four months later Paul was named to a committee charged with studying the city's solid waste program.

The changes weren't totally embraced by the community at first, and I recall a special city council meeting where citizens packed the council meeting room to express concerns about the new program.

During a particularly heated debate, Paul stood up

and launched into one of his fabled stories. About three minutes into the tale an older gentleman sitting next to me impatiently muttered something about the story not having anything to do with the issue at hand.

"Hang on," I told the man. "Paul is just using the story to make a point. Don't worry, he'll get around to it."

Minutes later Paul finished up the story and the man sitting next to me caught the connection.

"I don't believe it," he said aloud. "He just made the most important point of this whole damn meeting."

After the meeting I noticed the man walking up to Paul. He shook Paul's hand and began asking question after question. The two of them ended up walking out of city hall laughing. Paul had, once again, converted another skeptic.

There's not enough column space for me to paint a truly accurate picture of this man who had a lifetime love affair with this community, and I consider it unfortunate that I haven't had the pleasure of knowing Paul as much as many of you - I'm sort of the Johnny-come-lately in that department.

For the time I've known him I can only say this about Paul Folino. He was the type of man you always wanted on your side, the guy you could count on when the stakes were high to get the job done, and the man who would forever go out of his way to help his community.

City Manager Gary Word said it best when he told me that whether you agreed with his point of view or not, Paul Folino always wanted the best for Northville.

This community was truly lucky to have Paul Folino for a lifetime. Men of his stock don't appear often, and are never truly appreciated until after they are gone.

Robert Jackson is a staff writer for The Northville Record.

## In Focus

By John Heider



## Labs rule

JoAnne and Dale McDonald of Flint take a look at the Leader Dogs for the Blind exhibit at this past weekend's Dog Show at the Novi Expo Center. With the couple are two labrador puppies.

### King event caught spirit of leader

Batten down the hatches, troops: I do believe I'm gonna wax philosophic this week.

In case you missed it Monday was Martin Luther King Jr. Day. Here in Northville we honored it for the fourth year in a row with a silent walk downtown.

I've been to all four King walks and each year I find myself thinking about his place as an American patriot.

Why do I use that word? Because King continued a fight that's been going on since the Pilgrims set sail: the struggle for liberty.

Most of the people who've ever lived haven't had rights. In their worlds the biggest and the strongest made all the rules. Over the centuries, though, a few folks began to stand up and say, "Hey, bubba, that's not the way things should be."

The idea is that there's something better than the survival of the fittest. You have the right to certain things just because you are, not because of who or what you are.

Government, as Thomas Jefferson pointed out in the Declaration of Independence, only exists to secure those rights. Right after that he added that "whenever

any form of government becomes destructive of these ends, it is the right of the people to alter or to abolish it."

Martin Luther King Jr. was one of many who tried to alter a government, and to some extent a society, that wasn't securing their rights as human beings and, as Americans. He didn't call for the system's downfall. Instead he demanded that it live up to its fundamental promise.

That promise, in the words of Jefferson, is to give everyone a fair shot at life, liberty and the pursuit of happiness. Check out what King said in his "I have a dream" speech about his hope for the future:

"This will be the day when all of God's children will be able to sing with new meaning 'My country 'tis of thee, sweet land of liberty, of thee I sing. Land where my fathers died, land of the Pilgrim's pride, from every mountainside, let freedom ring.'"

I think Martin Luther King Jr. was about making it the best. I don't know what's written on his tombstone but maybe it's something like what Harry Truman hoped for.

Somebody once asked Truman what he wanted written on his tombstone. He said he'd like the inscription he saw on an old cowboy's grave in Arizona: *He done his damndest.*

Randy Coble is a staff writer for The Northville Record.



Randy Coble







# RECORD OUR TOWN

**B**  
THURSDAY  
January 23, 1997

## What's in a name?

From founding fathers to property lines, here's how some area street names came to be

Once you're familiar enough with a city or a route to and from work, you hang a left on this street and a right on that without giving it much thought. It's almost as if the car were on automatic pilot and there's no need to read the street signs.

But have you ever thought about how the street names came to be?

In Northville, many streets are named after founders, former city council members and mayors.

Dunlap, Hutton, Cady, Johnson and Gardner streets were all named in honor of founders, according to Northville Fire Chief Jim Allen. Allen Drive, Reed, Welch, Canterbury, Langfield and Ely were all council members or mayors of Northville.

When the family has been in the area a long time it becomes harder to determine which of the family members a street was named after.

Northville Historical Society member Diane Rockall, who is currently researching street names, sometimes uses the era of the development of part of the city as a clue to narrowing down which family

member a street was likely to have been named after.

The founding fathers were more likely to name streets after themselves, according to Rockall.

In Novi, street names usually came about because of location. The streets, which were once horse trails, cow paths or wagon trails, often bounded a family's property and connected various farm properties.

Some street names came about because they were known by the name of either the property owner who had the most road frontage or because of the destination, according to Kathy Mutch, Novi City Council member and president of the Novi Historical Society.

"The road that we know as Novi Road in this century was known as Novi Road from Grand River south and as Walled Lake Road north of Grand River," said Mutch.

"That is very common in small towns," Mutch said. "They were known by the destination, where they led to."

continued on 2

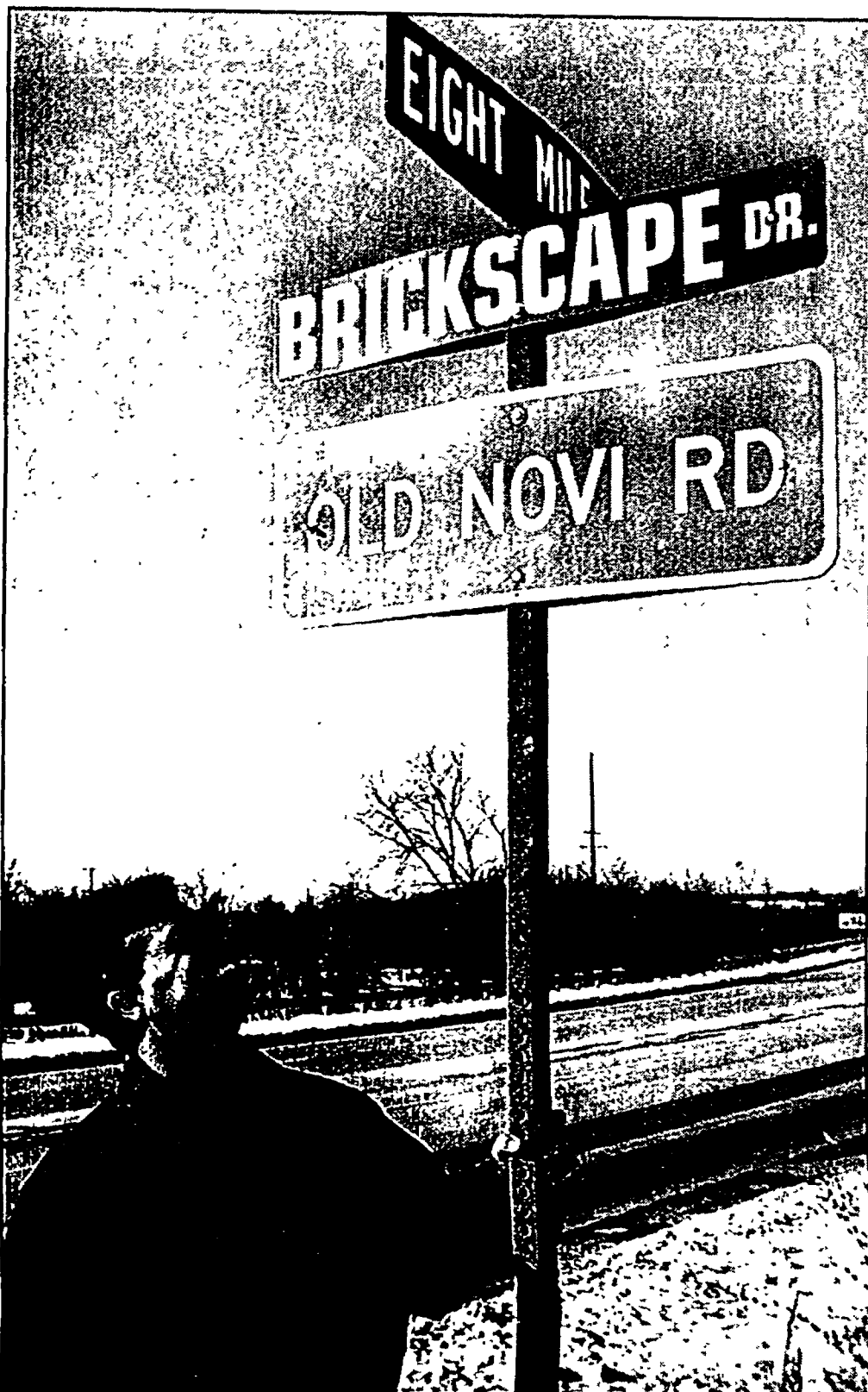
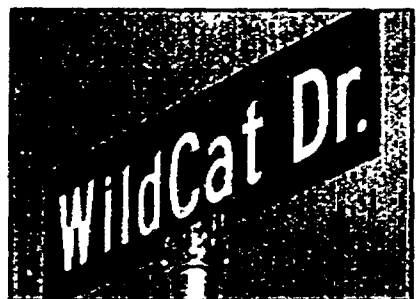
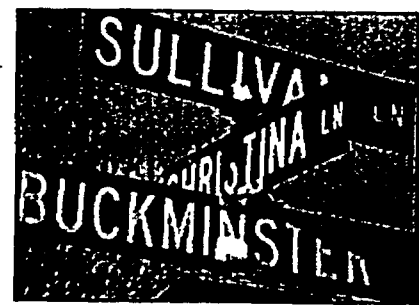

After completion of the renaming process, which lasted several months, Joe DiRado officially installs the new sign to Brickscape Drive, formerly known as Old Novi Road.

### Good-bye Old Novi Road, Hello Brickscape Drive

Old Novi Road is no more. The street is still there, of course, but it has been renamed Brickscape Drive.

The renaming process, which began nine or 10 months ago, came to completion in mid-December, when Joe DiRado, the co-owner of Brickscape Home & Garden Showplace officially installed the new sign on the post at Eight Mile Road in Northville. The Old Novi Road sign will remain on the post for about six months.

"It has always been hard to know how to get down here," said DiRado who opened Brickscape exactly 10 years ago on Jan. 1. "We knew that was the only way to do it."

To rename the road, DiRado had to get either the permission of the other landowners on the street or acquire all the property. He chose the latter.

Since Old Novi Road is a county road, DiRado

then needed to get the approval of Oakland County. Before the county would give their approval, they had to verify with both the cities of Novi and Northville that the street name did not conflict with any existing street names. Next, DiRado submitted and received approval for his request from both cities.

Prior to the change, DiRado said his mail was often delayed because the sender did not include the word "Old" in the address.

DiRado will consult with a landscape architect to begin improvements in the landscaping, particularly to the road.

"We're confident that we can make it look like a park atmosphere," he said. "A parks and rec atmosphere ties in with the business."

Rainbow Recreation, which sells swing sets, will remain at its site on the new Brickscape Drive, a location it has had for two years.

### Local street names and their history:

- Novi:**
- Country Lane Drive** - Located in Oak Ridge Place, the name was the result of a brainstorming session by everyone who worked on the development with Amar Chawney, architect, builder and developer.
  - Kartar Drive** - Located in Village Wood Place, this street was named in memory of the father of the developer, Amar Chawney. Kartar is another name for "the Lord."
  - Roethel Drive** - Mayor Romaine Roethel, the first woman mayor. Her husband was the chairman of the planning commission.
  - Karevich Drive** - Former mayor.
  - Griswold** - Myra Griswold owned the property which formed the boundary of the street that bears the name.
  - Dinser Drive** - The old Wixom Road was renamed for the Dinser family from Ten Mile Road north to Delmont, which is the new name for the east-west segment of old Wixom Road.
  - Austin Drive** - Cornelius Austin was a veteran of the War of 1812 and one of the first settlers in the lakes area. Austin owned property on both sides of Novi Road at Thirteen Mile Road.
  - Welfare Street** - Property owner George Welfare.
  - Bashian** - The Bashian family owned the orchard that ran south of Grand River into Ten Mile Road.
  - Brett** - Joe Brett was a former planning commission member.
  - Ron Heslop Drive** - Named for the last two years by the Heslop family after their successful bids at chamber of commerce auctions. The right to name the street, which is the entrance to the Novi Civic Center off Ten Mile Road by the police station, goes to the highest bidder once a year.
  - Wildcat Drive** - The name for the entrance on the west side of the Civic Center after the high school's mascot.
  - Simmons Drive** - The Simmons family owned the apple orchard on the property.
  - Grand River** - Originally named because it began in Detroit and ran all the way to the Grand River in Grand Rapids, at times paralleling the Grand River itself.
  - Garfield Road** - T. A. Garfield.

### In Northville and Northville Township:

- Allen** - Former Mayor A. Malcolm Allen.
- Reed** - E. Roscoe Reed, a former clerk and editor and publisher of The Northville Record.
- Welch** - Jackson Welch.
- Langfield** - Conrad Langfield, active in city government, whose father established the Northville Laboratories.
- Ely** - C. Ely, last village president and first mayor of Northville.
- Horton** - Edward S. Horton, installed as the Northville postmaster in 1899.
- Fry Road** - William Eves Fry.
- Dubuar** - Charles L. Dubuar was the village president in 1893, the school board president from 1909 until 1918 and a factory owner. James A. Dubuar was the village president in 1908.
- Pennell** - Ebenezer Pennell was the owner and manager of Pennell and Shaw, a mill where wool was processed.
- Yerkes** - Robert Yerkes, the owner of Globe Furniture.
- Thayer** - Hirman B. Thayer was a former township supervisor and also the superintendent of the U.S. Fish Hatchery.
- Beal** - F. R. Beal.
- Johnson** - Former Mayor Dr. Richard M. Johnson.
- Hutton** - Lewis W. Hutton came to Northville in 1854 and was the proprietor of Hutton & Bedford, a carriage shop.

Stories by Carol Workens • Photos by John Heider

### Volunteer



Daphne Richardson helps Northville's traveling seniors.

## Richardson's smile welcomes travelers

By CAROL WORKENS  
Staff Writer

If you've ever taken a trip offered by the Northville Senior Center chances are you've met Daphne Richardson.

Born in London, England, Richardson began volunteering with the Northville Senior Center two years ago, just six months after retiring.

"I decided I wasn't going to be one of these women who lived with my husband 24 hours a day," Richard said. "He does his thing and I do my thing. We get together for a date once a week."

As the group leader on trips, Richardson greets people as they get on the bus and makes everyone feel welcome.

"I usually try to make everybody feel they're part of the group, rather than just one person on the bus," she said. "Everybody kind of enjoys it as a group rather than as a single person because there are single persons that go."

Richardson said that she "got to know how to handle all kinds of people" while she worked in a hotel

in St. Croix in the Virgin Islands for two years.

As a group leader she'll count heads and sees to it that no one gets lost.

"I make sure that everybody who gets off the bus gets on the bus," she said.

Richardson also helps Karl Peters, director of the senior center, with anything else that needs to be done.

She is very willing to lift a hand when it's time to send out meeting notices and the monthly newsletter. If Peters needs help with the shopping for the center, Richardson is there. When it's time for flu shots, you can bet she will be one of the volunteers on hand. From helping in the office to polluck luncheons, whenever she receives a call from Peters, she's more than happy to oblige.

"Whenever they need me I go," she said. "It's marvelous, because you get to meet the most wonderful people."

Continued on 3

### It's A Fact

#### HOME IMPROVEMENT

There were 571 Novi homeowners receiving permits in 1996 for alterations. The estimated value of the renovations came to \$3,564,578.





# Seniors don't worry about missing the bus

Continued from 1

Richardson, who lives with her husband, Bill, in Farmington Hills, usually goes on the trips the seniors take in their own bus. The trips are sporadic but usually take place once a month.

January through May are the busiest months. Activities slow down at the end of May until October.

Trips include the Detroit Institute of Arts, the Detroit Symphony at Orchestra Hall, Cedar Point, Frankenmuth and Birch Run.

"I gain much more than I give," Richardson said.

"If somebody wants to meet people it is a great way to meet people," she said. "I've met so many wonderful people."

Turnouts for the trips vary. Sometimes trips go over big, sometimes they don't and it's hard to predict which will be sell outs.

"It keeps these people out and alert and active," she said.

The senior center is temporarily working out of the Northville Recreation Center while their facility is being renovated.

For more information about volunteer possibilities, call Karl Peters at 349-4140.

## Births



### Kellan Flayer

Sally and Edward Flayer of Northville announce the birth of their fourth child, Kellan James, on Aug. 9, 1996. He was born at the University of Michigan Women's Hospital in Ann Arbor, and weighed 9 pounds, 10 ounces. Awaiting him at home were Bethany, 8, Brendan, 6, and Connor, 3.

His grandparents are Edward and Betty Flayer of Flat Rock and the late Thomas and Joan Johnson, who were also from Northville.

Kellan's middle name, James, comes from his great grandfather, James Johnson.



### Hunter Sells

Andy and Heidi Sells of Northville announce the birth of their daughter, Hunter McCormack, on Nov. 11, 1996, at William Beaumont Hospital. She weighed 6 pounds, 9 ounces.

Grandparents are Dan and Cheri Sells of St. Louis, Mo., Barb Kirkwood of Chesterfield, Mo., and Barry and Marie Hold of Ballwin, Mo. Her great grandparents are James Sells of Roanoke, Va., and Mrs. J. Brooks of Salem, Va., and Mr. and Mrs. B.N. Trombley of Charlotte Harbor, Fla.

## Seventh Annual Northville Record and Novi News

### Restaurant Poll

Which restaurants in the Northville/Novi area are the most popular? Help find out by filling out this ballot.

#### The Rules:

- Only restaurants in Northville and Novi are eligible to be mentioned on your ballot. Each ballot must include your name, address and telephone number. Ballots without this information will not be included in the results.
- Only ballots clipped from the newspaper will be accepted. Photocopied ballots will not be counted. This restriction is designed to help avoid ballot-box stuffing. (HomeTown employees and their families are not eligible for the free dinner.)
- Restaurants found to be distributing ballots will be disqualified.

Mail the completed entry form by Jan. 31 to: Northville Record/Novi News restaurant poll, 104 W. Main, Northville, MI 48167.

If you prefer, restaurant poll entry forms may be dropped off at the newspaper office.

When all the ballots are in, we will compile the results and publish them in the Feb. 20 issues of The Northville Record and The Novi News. The results of the Best Chef and Best Waitperson categories will be published on Feb. 27.

In case you misplace this edition of the newspaper, entry forms will also be published in subsequent issues.

One ballot will be selected at random and the winner will receive dinner for two at his or her favorite Northville or Novi restaurant.

#### The Categories:

- Best Overall Restaurant \_\_\_\_\_
- Best Inexpensive Restaurant \_\_\_\_\_
- Best Breakfast Restaurant \_\_\_\_\_

Best Waitperson \_\_\_\_\_

Best Chef \_\_\_\_\_

Best Sandwiches \_\_\_\_\_

Best Desserts \_\_\_\_\_

Best Coffee \_\_\_\_\_

Best Salad \_\_\_\_\_

Best Pizza \_\_\_\_\_

Best Burgers \_\_\_\_\_

Best Seafood \_\_\_\_\_

Best Ethnic Food \_\_\_\_\_

Best Fast Food \_\_\_\_\_

Best Soups \_\_\_\_\_

Best Steak \_\_\_\_\_

Best Gathering Place \_\_\_\_\_

Comments \_\_\_\_\_

\_\_\_\_\_

\_\_\_\_\_

\_\_\_\_\_

PLEASE NOTE: The following name and address blank must be filled out. Ballots without this information will be discarded.

Your name \_\_\_\_\_

Street \_\_\_\_\_

City \_\_\_\_\_

Phone \_\_\_\_\_

## Church Notes

**ST. PAUL'S LUTHERAN CHURCH.** 201 Elm Street behind Shopping Center Market, presents a Bible study session with Connie Davis, president of Lutherans for Life of Michigan, on Sunday, Jan. 26, from 10 until 10:45 a.m. in the school's gym. Teens and adults from the community are welcome to attend.

For more information, call the church at 349-3140.

Send church information to The Northville Record and The Novi News, 104 W. Main St., Northville, MI 48167.

## Singles

**SINGLE PLACE.** an adult ministry for single people, meets at First Presbyterian Church of Northville Sunday at 9:45 a.m. for a Sunday morning gathering, followed by a worship service at 11 a.m. and brunch at Northville Crossing at 12:30 p.m. The topic is "Prayer."

On Wednesday, Jan. 22, at 7:30 p.m., the evening's topic will be "Creating Yourself" with speaker Joan Feldman. Also on Wednesday, a country line dance class will be taught by Linda Laney.

Sports events for the month include bowling and volleyball on Jan. 31. Bowling is at Novi Bowl, 21700 Novi Road. The cost is \$6 plus shoes. Volleyball is held at the Northville Recreation Center, 303 W. Main Street. The cost is \$4.

A country couples, slow dance-mixers dance class led by Jeff Groff began on Jan. 16 and runs for six weeks through February 20 at 7:30 p.m. The cost is \$24 in advance and \$28 at the door. It is recommended that you bring a partner.

Social activities include an Italian night at Roman's Forum on Jan. 24 at 7:30 p.m. followed by whirlyball at Scoop & Shoot at 9:45 p.m. The cost is \$16 and reservations are required.

For more information about any of the Single Place programs or to register, call 349 0911.

**FARMINGTON SINGLE PROFESSIONALS** is a non-profit group for singles ages 25-40 who share common interests and want to form new friendships. Membership is not limited to the Farmington area. The group participates in over 350 activities per year.

A casual Super Bowl Party is planned on Sunday, Jan. 26, at Drake's Lanes located on Grand River east of Drake Road in Farmington beginning at 5:30 p.m. The event is free if you bring a dish to pass. No munchies.

Every Monday night the group meets at the Maples of Novi on Fourteen Mile Road for a \$8 dinner at 6:30 p.m. The cost is \$7 for members and \$8 for non-members. Cash, bar and munchies are available.

For details on upcoming activities and information about Farmington Single Professionals call the FSP hot line at (810) 851-9909.

Send Singles information to The Northville Record and The Novi News, 104 W. Main St., Northville, MI 48167.

## On Campus

Northville resident **JEANNIE HOOT** was recently inducted into Madonna University's Kappa Iota chapter of the Sigma Theta Tau, an International Nursing Honor Society. Hoot is a senior at Madonna.

**JEFFREY R. HARP** recently graduated from the University of Wisconsin-Madison. He received his master's degree in business administration with a dual major in finance, investment and banking, and operations and information management.

He is employed at General Motors Truck and Bus Division in Janesville, Wis., and will transfer in February to General Motors Technical Center in Warren.

Harp is a 1991 graduate of Michigan State University and a 1986 graduate of Northville High School.

**JULIE ZWIESLER**, a senior, was named to the Dean's List at Hope College for the first semester of the 1996-97 school year. To be named to the Dean's List, a student must earn a minimum 3.5 grade point average.

Zwiesler is the daughter of Mr. and Mrs. Martin Zwiesler of Northville.

**JASON W. WENZEL**, a freshman at Albion College, earned a perfect 4.0 grade point average for the fall semester, advancing his overall grade point average to 3.894.

Wenzel, an economic management/pre-law major, is the son of William and Nancy Wenzel of Novi. Wenzel is a 1995 graduate of Northville High School.

# THE SPORTS AUTHORITY

OUR EVERYDAY LOW PRICES JUST GOT LOWER!

On All Ski Parkas  
All Ski Pants  
All Piece Ski Suits

**ROSSIGNOL**

NOW **139<sup>97</sup>** ORIG. 199.99

**VCT SKIS**

NOW **219<sup>97</sup>** ORIG. 279.99

**MORROW AM SERIES SNOWBOARD**

**30% OFF**  
OUR EVERYDAY LOW PRICES  
NOW **48<sup>97</sup>-118<sup>97</sup>** ORIG. 69<sup>97</sup>-169<sup>97</sup>  
Mobius Ski Clothing

**59<sup>97</sup>-118<sup>97</sup>** ORIG. 87<sup>97</sup>-169<sup>97</sup>  
Below Zero Snowboard Clothing

Styles shown are representative of selection and may vary by store.

<b>Miller Road</b> 1178 FLINT 810-230-8180	<b>WATERFORD</b> (810) 738-5020	<b>UTICA</b> (810) 254-8850
<b>CLINTON TOWNSHIP</b> (810) 791-8400	<b>LIVONIA</b> (313) 522-2750	<b>TAYLOR</b> (313) 374-0505
<b>MADISON HEIGHTS</b> (810) 589-0133	<b>DEARBORN</b> (313) 224-8221	

STORE HOURS MON-FRI 10AM-9:30PM SAT 9AM-9:30PM SUN 10AM-6PM

No ads at our Clinton Township, Dearborn, Taylor and Flint stores.

# Heslop's

TAKE AN ADDITIONAL 20% OFF  
HESLOP'S EVERYDAY LOW PRICES ON  
SELECT DINNERWARE, FLATWARE, STEMWARE,  
AND GIFTWARE.

Heslop's brings you the largest selection of in-stock tabletop merchandise in Michigan. Choose from among such famous names as Atlantis, Block, Christian Dior, Cristal J.G. Durand, Dansk, Fitz & Floyd, Gorham, Lenox, Mikasa, Nikko, Noritake, Oneida, Pickard, Reed & Barton, Rosenthal, Royal Doulton, Royal Worcester, Sasaki, Spode, Towle, and Villeroy & Boch.

Sale does not include previously marked down merchandise. Select manufacturers' patterns are excluded. Please ask a salesperson for details.

THURSDAY, JANUARY 23-SUNDAY, JANUARY 26

<p><b>METRO DETROIT:</b> Dearborn Heights, The Heights • (313) 274-8200 (Ford Rd. between Inkster and Beech Daly) Livonia, Merri-Five Plaza • (313) 522-1850 (On corner of Five Mile and Merman) Novi, Novi Town Center • (810) 349-8090 Rochester, Meadowbrook Village Mall • (810) 375-0823 Roseville/St. Clair Shores • (810) 293-5461 Sterling Heights, Eastlake Commons • (810) 247-8111 (On corner of Hall Road and Hayes Road)</p>	<p>Troy, Oakland Mall • (810) 589-1433 West Bloomfield, Orchard Mall (810) 737-8080 (Orchard Lake and 15 Mile)</p> <p><b>OUTSTATE:</b> Ann Arbor, Conlona • (313) 761-1002 (On Eisenhower Pkwy. west of Branwood Mall) Grand Rapids, Breton Village Mall (616) 957-2145 (Breton Rd. and Burton Rd.) Open Sundays! Okemos, Meridian Mall • (517) 349-4008</p>
---	--

INTRODUCE THE BRIDE-TO-BE TO HESLOP'S BRIDAL REGISTRY  
THE BRIDAL REGISTRY OF CHOICE

Coming Soon Heslop's in St. Clair Shores!

**Engagements**



**David Hall/Michelle Buie**

Mr. and Mrs. James Buie of Westland announce the engagement of their daughter, Michelle Suzette, to David Graham Hall, the son of Mr. and Mrs. Samuel Hall of Northville.

The bride-elect graduated from Wayne Memorial High School and will receive her associate degree in nursing from Schoolcraft College in April.

The bridegroom-elect graduated from Northville High School in 1986, and received his building construction and management degree from Michigan State University in 1990.

David currently runs his own construction and remodeling company, David Hall Construction.

A May 10 wedding is being planned.



**Michael Hale/Shannon Spence**

Mike and Pam Spence of Northville announce the engagement of their daughter, Shannon Sue, to Michael William Hale, the

son of Robert and Mary Hale of Stuart, Fla.

An April 26 wedding is being planned.



**Maria MacInnis/Martin Pierce**

Mr. and Mrs. John MacInnis of Northville announce the engagement of their daughter, Maria, to Martin Pierce, the son of Mr. and Mrs. David Pierce of Los Alamos, N.M.

The bride-elect is a 1991 graduate of Northville High School and received her degree in marketing from Michigan State University in 1995.

Maria is a consultant with Met-

Life in Southfield in the benefits program division.

The bridegroom-elect graduated in 1990 from Los Alamos High School and received his degree in mechanical engineering from Michigan State University in 1995. He is a design engineer for Jacobsen Corp. in Racine, Wis.

A May 1997 wedding is planned at Our Lady of Victory Church in Northville.

**CITY OF NOVI  
NOTICE**

NOTICE IS HEREBY GIVEN that there are upcoming vacancies on the Board of Review, Beautification Committee, Cable Access Committee, Computer Advisory Committee, Economic Development Corporation, Election Commission, Housing & Community Development Advisory Committee, Historical Commission, Library Board, and Senior Citizen Housing Building Authority. Applications are available in the office of the City Clerk by calling 347-0456. Council will be interviewing applicants Monday evening, February 3rd, please submit your application by January 27th to allow time for scheduling appointments.

(1-9/16/23-97 NR, NN) TONNI BARTHOLOMEW, CITY CLERK

**CITY OF NOVI  
NOTICE OF ADOPTION  
ORDINANCE NO. 97-110.04**

NOTICE IS HEREBY GIVEN that the Novi City Council has adopted Ordinance 97-110.04, an Ordinance amending Sections 17-17, 17-18 and 17-18 of the Novi Code of Ordinances, to alter the number of members of the City of Novi Historical Commission.

The provisions of the ordinance shall become effective fifteen (15) days after adoption. The Ordinance was adopted by the City Council on Monday, January 13, 1997 and the effective date is January 28, 1997. A complete copy of the Ordinance is available for public use and inspection at the office of the City Clerk during the hours of 8:00 a.m. and 5:00 p.m. prevailing eastern time.

(1-23-97 NR, NN) TONNI BARTHOLOMEW, CITY CLERK

**NOTICE OF PUBLIC HEARING  
CHARTER TOWNSHIP OF NORTHVILLE**

Date: January 28, 1997  
Time: 7:00 p.m.  
Place: Northville Township Civic Center  
41600 West Six Mile Road

The Planning Commission of the Charter Township of Northville has scheduled a Public Hearing for Tuesday, January 28, 1997 at 7:00 p.m. at the Northville Township Civic Center, 41600 West Six Mile Road, Northville, Michigan, on proposed Zoning Ordinance Amendments. The proposed changes apply to Article 20, Site Plan Review, Article 21, Zoning Board of Appeals, Article 23, Zoning Ordinance Amendments, and Condominium Regulations. The public is invited to attend this public hearing and express their comments and questions. Written comments regarding the proposed changes will be received by the Township Planning Commission, 41600 West Six Mile Road, Northville, Michigan 48167. The text for the proposed changes are available for review in the Planning Department between the hours of 8:00 a.m. and 4:00 p.m. Monday through Friday.

(1-9/23-97 NR) RICHARD ALLEN, VICE CHAIR  
PLANNING COMMISSION

**NOTICE OF PUBLIC HEARING  
CHARTER TOWNSHIP OF NORTHVILLE**

Date: January 28, 1997  
Time: 7:00 p.m.  
Place: Northville Township Civic Center  
41600 West Six Mile Road

The Planning Commission of the Charter Township of Northville has scheduled a Public Hearing for Tuesday, January 28, 1997 at 7:00 p.m. at the Northville Township Civic Center, 41600 West Six Mile Road, Northville, Michigan, on an Open Space Community Development Option for SP 96-36 Edward Rose Property.

The Open Space Community Development Option is proposed for land located in the Southwest 1/4 of Section 10, and the Northwest 1/4 of Section 15 North and South of Six Mile Road, West of Sheldon.

The public is invited to attend this public hearing and express their comments and questions. Written comments regarding this proposed development will be received by the Township Planning Commission, 41600 West Six Mile Road, Northville, Michigan 48167. The plans for this proposed development are available for review in the Planning Department between the hours of 8:00 a.m. and 4:00 p.m. Monday through Friday.

(1-9/23-97 NR) RICHARD ALLEN, VICE CHAIR  
PLANNING COMMISSION

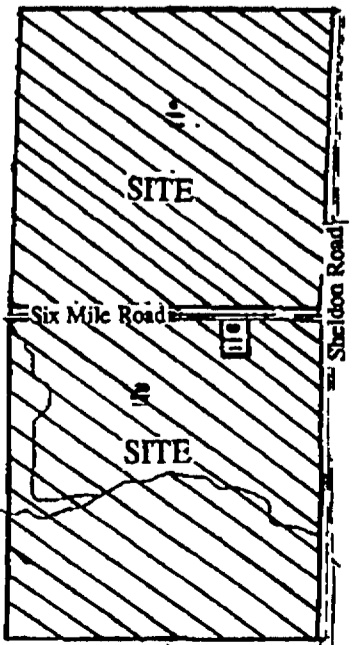

**Are you managing everything except your own health?**



If you're like most women, you're so busy taking care of your family - your children, husband, parents or other loved ones - it's hard to find time for yourself. But finding time for annual check ups is the best defense against breast and ovarian cancer, osteoporosis, diabetes and cardiac disease. **B**otsford General Hospital offers a continuum of services to assist you in maximizing your health. If you would like a physician referral, call Health Match at (810)442-7900. **I**f you're in the prime of your life - 40 and up, take time out for Prime Time for Women, Saturday, February 1 from 9:00 am - 5:30 pm at **B**otsford General Hospital in the Zieger Center. The day will include sessions on menopause, osteoporosis, cardiac health, stress management, a demonstration on healthy cooking, and fashion and make-up demonstrations by Parisian. **A** continental breakfast and lunch will be served. There is a minimal fee per person, with discounts for signing up with a friend. To register call Community Relations at (810) 442-7986. Due to popularity, there may be a waiting list. So call today and maximize your health.



Reaching Out To The People Of Our Community  
28050 Grand River Avenue Farmington Hills, MI 48336-5933









# RECORD MOVIES

**7B**  
THURSDAY  
January 23, 1997

## Woody Allen charts new territory with 'Everyone Says I Love You'

Woody Allen's latest film, "Everyone Says I Love You," is a celebration of an eccentric and very extended family living on New York's upper east side, exploring a broad spectrum of romantic entanglements as they fall in and out of love.

Alan Alda, Drew Barrymore, Lucas Haas, Goldie Hawn, Gaby Hoffman, Natasha Lyonne, Edward Norton, Natalie Portman, Julia Roberts, Tim Roth, David Ogden Stiers and Woody Allen star in "Everyone Says I Love You," which marks the first time Allen has written and directed a musical.

"This film is experimental for me. I've never tried anything like this musical before," explains Woody Allen. "The truth is I don't even think of it as a musical but as a comedy where the characters sing and dance. I always wanted to do a film where people sang not as slick singers but as an extension of their acting at the moment."

"Music has always played an important part in Woody's movies," observes Alan Alda. "When you think of the Gershwin that was played during the opening montage in Manhattan and how powerful it was, you were already transported into another world before anybody said a line of dialogue."

Allen's first three films had traditional background scores, two composed by Marvin Hamlisch, before the director decided to use music from his second record collection. Eventually, Allen evolved a confident cinematic style in which he would use existing music. On "Everyone Says I Love You," Allen's 26th film, the director worked with Dick Hyman, who orchestrated the music.

In casting this film, Allen was not looking for trained singers and dancers. "In fact, when I cast this picture I never told people that they'd have to sing or dance, or even asked them if they could," the director says.

"I was only interested in if they could act their role well, as far as dancing and vocals I just wanted honest and simple emotion. Often the most interesting renditions of songs are done by people who don't really have particularly good voices but are good actors, full of feeling and a certain kind of charisma or emotion. That was much more important to me."

Of the large ensemble cast of "Everyone Says I Love You," only Goldie Hawn and Alan Alda had



Drew Barrymore and Edward Norton star in Woody Allen's musical, "Everyone Says I Love You."

any significant experience in musical comedy. For the most part, virtually all of the actors involved in this project had no idea that Allen was casting them in a musical.

"About a month after I got the part I got a call from Dick Hyman telling me that he was going to send me some sheet music," recalls Edward Norton. "I asked him if my character in the film was a singer, and he told me that we were doing a musical. That was the first I knew about it."

The songs used in "Everyone Says I Love You" were chosen specifically because they either advance the plot or they express emotions that characters involved are feeling. So much of the music used in this film has to do with conditions of the human heart.

"The people in this film are singing the emotion of the story at the time," explains Woody Allen. "I tried to always keep the story moving."

"This is a broad film, almost like a cartoon. These are characters that are fun and larger than life."

Allen is inclined to compare "Everyone Says I Love You" more

in style to "Bullets Over Broadway" and "Purple Rose of Cairo," two of his previous films that told stories set against a tapestry of larger-than-life, often cartoon-like, characters.

"With this film, I was trying to make an amusing, entertaining

confection," concludes Allen. "I always wanted to do a film that took place in my three favorite cities — New York, Paris and Venice. And most important of all, I always wanted to play a scene with a mustache. What more can I say about this movie?"

**"AN OUT-OF-YOUR-SEAT SUSPENSE THRILLER. DON'T MISS 'THE RELIC'!"**  
— *Joe Fagan, PRESIDENT CHANNEL*

**"More frightening, more terror? Not since 'Aliens'!"**  
— *ENTERTAINMENT WEEKLY*

**THE RELIC**

www.relicmovie.com

AMC BEL AIR 10	AMC EASTLAND 5	AMC SOUTHFIELD CITY
GENERAL CANTON	QUO VADIS	SHOWCASE AUBURN HILLS
SHOWCASE 2749 10 11 12 PONTIAC	SHOWCASE STERLING HEIGHTS	STAR GRATIOT AT 15 MILE
STAR LINCOLN PARK 8	STAR ROCHESTER HILLS	STAR TAYLOR
UNITED FAIRLANE	UNITED ARTISTS LAKESIDE	UNITED ARTISTS OAKLAND
UNITED ARTISTS 12 OAKS	UNITED ARTISTS WEST RIVER	NO PASSES OR COUPONS ACCEPTED

## Simplicity of 'Smoke' lingers with reviewer

SMOKE  
BY DENISE FOX PRATT  
MILFORD

READER  
**MOVIE**  
REVIEWS

"Smoke" is the name of a movie I had scribbled on a "must see" list from some magazine article a while ago, and finally rented to watch and find out why it was on that list.

This is a Good Samaritan story, the story of two men living in modern New York City, Paul Benjamin (William Hurt) and Auggie Wren (Harvey Keitel), whose lives become briefly intertwined with other Good Samaritans.

Each is presented with an opportunity to help someone out — Paul to help out Rashid (Harold Perrineau, Jr.), a young man who saved Paul's life, and Auggie to help out his old girlfriend, Ruby (Stockard Channing) with a daughter she claims has a "50 percent chance of being Auggie's."

Forrest Whitaker plays Cyrus Cole, who by his kindness to Rashid wins the opportunity to right an old wrong.

No one has a major obligation to the person each assists. It just seems to be something each does, the way life is. That may seem a bit corny in today's

world, but the performances are low key with no preachy editorials included in the script.

William Hurt plays Paul with an unassuming, almost vulnerable presence. Harvey Keitel plays Auggie with a hint of "slime balliness" tempered by an affable and ordinary character.

The strength of the movie is in its simplicity. Paul and Auggie are men who are not driven by the whirlwind of modern city life. Each is a working man and a thinking man.

And like the Good Samaritan, the effect on them for the doing of the deeds is subtle, almost unnoticeable, like the smoke from a fine cigar — weighty, but quickly diffused into the air and almost forgotten.

**DISCOVER THE MIRACLE OF FRIENDSHIP**

Steve Guttenberg Kathleen Quinlan

**Zeus and Roxanne**

AMC ABBEY 8 STARTS FRIDAY, JAN. 24 AMC AMERICANA WEST

AMC BEL AIR 10	AMC EASTLAND	AMC LAUREL PARK
AMC SOUTHFIELD CITY	AMC STERLING CTR. 10	GENERAL CANTON
QUO VADIS	SHOWCASE AUBURN HILLS	SHOWCASE PONTIAC
SHOWCASE STERLING HEIGHTS	STAR GRATIOT AT 15 MILE	STAR LINCOLN PARK 8+
STAR TAYLOR	STAR WINCHESTER 8+	UNITED ARTISTS FAIRLANE
UNITED ARTISTS 12 OAKS	UNITED ARTISTS WEST RIVER	NO PASSES OR COUPONS ACCEPTED

**THE MOST ACCLAIMED COMEDY OF THE NEW YEAR!**

WINNER of the New York Film Critics Circle Award for Best Screenplay  
WINNER of the National Society of Film Critics Award for Best Screenplay  
**ONE OF THE TEN BEST FILMS OF THE YEAR**

THE NEW YORK TIMES • NEWSDAY • THE VILLAGE VOICE • N.Y. DAILY NEWS

ALBERT BROOKS DEBBIE REYNOLDS  
**MOTHER**

www.mothermovie.com

AMC LAUREL PARK	NOW PLAYING	MAIN ART THEATRE
SHOWCASE 1 2 3 4 5 PONTIAC	SHOWCASE WESTLAND	STAR GRATIOT AT 15 MILE
STAR WINCHESTER 8	UNITED ARTISTS WEST RIVER	NO PASSES OR COUPONS ACCEPTED

TIME MAGAZINE says:  
**"YOU MUST SEE 'EVITA'!"**  
— Richard Coftis

MADONNA ANTONIO BANDERAS JONATHAN PRYCE  
**EVITA**

www.EVITA-TheMovie.com • NO PASSES OR COUPONS ACCEPTED

AMC LAUREL PARK	AMC MAPLE 3	AMC WOODS 6
AMC SOUTHLAND 4	AMC STERLING CTR. 10	BIRMINGHAM 8
GENERAL CANTON	MAIN ART THEATRE	SHOWCASE AUBURN HILLS
SHOWCASE 1 2 3 4 5 PONTIAC	SHOWCASE STERLING HEIGHTS	SHOWCASE WESTLAND
STAR GRATIOT AT 15 MILE	STAR JOHN R AT 14 MILE	STAR ROCHESTER HILLS

**"EDDIE MURPHY IS BACK IN TOP FORM!"**  
— Gene Siskel, CHICAGO TRIBUNE

"IT'S FUN! INGENUOUS ACTION SEQUENCES!"  
— Roger Ebert, CHICAGO SUN-TIMES

"UNBELIEVABLE ACTION! THE NUTTY AGGRESSOR IS BACK!"  
— Doug Moore, WDAF-TV (FOX, Kansas City)

"THE ROLLER-COASTER RIDE OF YOUR LIFE!"  
— Maria Salas, CBS-TELENOTICIAS

"FAST-TALKING, FAST-SHOOTING, IN-YOUR-FACE CHARMER!"  
— Michael A. Hinton, CHICAGO TRIBUNE

**EDDIE MURPHY METRO**

LIFE IS A NEGOTIATION.

www.movies.com • FOR THEATRES & SHOWTIMES CALL 810 77-FILMS/313 88-FILMS

AMC BEL AIR 10	AMC EASTLAND 2	AMC SOUTHFIELD CITY
AMC SOUTHLAND	AMC STERLING CTR. 10	AMC WONDERLAND
GENERAL CANTON	GENERAL CANTON	NORWEST
QUO VADIS	RENAISSANCE 4	SHOWCASE AUBURN HILLS
SHOWCASE DEARBORN	SHOWCASE PONTIAC	SHOWCASE STERLING HEIGHTS
STAR GRATIOT AT 15 MILE	STAR JOHN R AT 14 MILE	STAR LINCOLN PARK 8
STAR ROCHESTER HILLS	UNITED ARTISTS WEST RIVER	NO PASSES OR COUPONS ACCEPTED

## Gymnasts win Hartland Invitational - easy

**By SCOTT DANIEL**  
Sports Editor

In gymnastics you've got to make hay with the judges when you have the opportunity. That means impressing them at big meets. Northville did just that Saturday and easily won the Hartland Invitational.

The combined team best out nine other schools by scoring 141.9 points. Hartland finished second with 137 and Freeleaf was a distant third at 135.5 points.

Coach Barb Winn said it was important for her team to perform well before judges they'll like, see in state competition later.

"Last year," she added, "Hartland beat us at the invitational. We didn't want to be in the same situation this year."

While each gymnastic event has certain skills that must be executed well in order to achieve a high mark, scores are ultimately subjective.

And like it or not, teams do get reputations for their strengths and weaknesses with those judges. So it often pays to make a good first impression - like the Mustangs did Saturday.

Winn said her team's performance showed that car-

ter wins over Canton and Salem were no fluke.

"It shows the scores we received were realistic and not over inflated," she added.

The coach also called the meet a "good indicator" in terms of where Northville/Novi stands in its conference. Hartland is considered to be the combined team's strongest challenger for the title.

Winn said it will be hard for the Eagles to close that four point gap on her team.

"But I think everyone will improve," she commented.

Northville/Novi showed what it is one of the best teams in the state by taking at least four places in each event Saturday.

Nicole Pelletier finished second overall on the vault. She finished with an average of 8.55.

Stacey Williamson was fourth at 8.45. Marv Essary fifth at 8.4 and Erica Winn seventh at 8.35.

Points were awarded for the top eight finishes in each event.

The combined squad just about swept through the uneven bars.

Essary won with a 9.1. Winn was second at 9.05 and Missy MacRae took fourth at 8.9. Jenni Rohlis and Williamson each scored 8.7 to take fifth and sixth, respectively and Daneen Pazdan was eighth at 8.6.

On the balance beam, MacRae was the champion with a 9.3 performance. Essary took second at 9.15. Winn fourth at 8.7 and Williamson seventh at 8.4.

In the floor exercise MacRae was first at 9.4. Essary second at 9.3 and Williamson fourth at 9.2. Pelletier took eighth place in Division II with an 8.65 and Winn was eighth in Division I with an 8.6.

Northville/Novi is undefeated on the season having won all three dual meets and the Hartland Invitational.

About the season's only negative note thus far its injuries.

Rohlis has leg problems and Essary's ankles are tender. Several other gymnasts are nursing nagging injuries.

With almost all of her gymnasts qualifying for the state regional, Barb Winn said she'll be able to rest most of her injured performers over the next few weeks.

Unfortunately, injuries are a part of gymnastics.

"We've got a lot of kids with aches and pains," Winn

said.

**MUSTANGS 142.15**  
**SALEM 137.25**

The combined team faced Salem at Northville High on Jan. 14 and won easily.

Rohlis was first in the vaulting competition with an 8.95 and Winn was second at 8.9. Williamson scored an 8.6 and Essary, on 8.5 to round out the team score.

On the uneven bars, Essary led a sweep for Northville/Novi by scoring 9.15. MacRae was second at 9.1 and Rohlis third at 8.7.

Essary also won the balance beam competition. She scored a 9.0. Kristin Levin was second at 8.8 and Winn was third at 8.75. MacRae noted an 8.5 to round out the team's score in the event.

Northville/Novi closed the meet in strong fashion by sweeping the floor event.

Essary and MacRae tied for first at 9.2. Williamson tied for second at 9.1 and Winn was third at 9.05.

**MUSTANGS ON TV**

The combined team will face Uxbridge Saturday on channel 48 "Hot 60.5". The show runs at 11:30 a.m. and can also be seen on Sundays at noon.

## Grapplers second at Brighton tourney

**By SCOTT DANIEL**  
Sports Editor

After a slow start it appears the Mustang wrestling team is improving.

Northville High finished second in the Brighton team tournament. The Mustangs posted a 3-2 record on the day - which brought them to within a victory of 500 for the season.

"We deserved to place second," said assistant coach Bob Townsend. "We definitely the second best team there."

He added that it was a solid effort.

"As a team we wrestled well all day," Townsend commented. "We're progressing nicely."

Brighton was the tournament. Fenton and Ann Arbor Huron also posted 3-2 records but the Mustangs got second on tie breakers.

"We had 41 total wins and Fenton only had 36," Townsend said.

Northville opened the day by losing to the Tigers though 36-30.

Mustang winners in the match were Nick Straman (119 pounds), Dan Scappaticci (135), Jason Kera nen (140), Jason Brodie (145), Ryan McCracken (160) and Brian Grider (171).

"We were upset after that loss," Townsend said.

Ann Arbor Pioneer paid the price for the anger as the Mustangs won their second round match 53-12.

Keranen (140) and Mike Livanos

(215) got pins. Ben Ashby (103), Rick Torrence (112), Anant Saran (125), Scappaticci (135), McCracken (160) and Grider (171) earned decision victories. Straman (119) and Ryan Giles (169) won by forfeit.

Northville then pounded Jensen 49-24.

Torrence (112), Saran (119), Keranen (140) and Grider (171) won by pins. Erik Staples (125), Scappaticci (135) and Rob Clark (215) took decisions. McCracken (160), Giles (169) and Ted Bowersox (heavyweight) won by forfeit.

The Mustangs final victory came with a 45-24 win over Ann Arbor Huron.

Ashby (103), Staples (130), Kera nen (140) and Bowersox (heavyweight) won by forfeit. Torrence (112) won by pin while Straman (119), Scappaticci (135) and Grider (169) took decisions.

Northville faced Brighton in the final match of the day and fell 45-28.

The match was highlighted by the performance of Grider at 171 pounds. He pinned his man in just nine seconds one second off the school record held by Townsend and Brandon Mardosian.

"He was our wrestler of the week," Townsend said. "He comes up with a lot of big wins for us."

Other Northville winners were won Torrence (112), Straman (119)



**Continued on 9** Northville's Rick Torrence went 3-1 in Saturday's Brighton Invitational.

## Hawks edge eagles 58-56

**By SCOTT DANIEL**  
Sports Editor

Better but not good enough.

That's probably the best way to sum up Northville High's 58-56 home loss to Farmington Hills Harrison Friday night.

The Mustangs played solid basketball. But an offensive dry spell in the closing minutes of the game added up to Northville's third straight defeat.

"There was four or five possessions in the fourth quarter where we were not successful and they were," coach Tim Turner said.

Northville led the entire way. But when the Hawks got the lead with about three minutes to go the Mustangs simply couldn't respond.

"The game pretty much went the way we wanted," Turner said. "We just came up short."

Northville fell to 4-4 with the loss. The Mustangs played North Farmington Tuesday (after Record dead line) and will go up against Livonia Churchill tomorrow on the road.

"This is a big week for us," said Turner. "These are two league games we need to win."

The Mustangs beat North Farmington by 18 points during the Christmas tournament. Tomorrow's game with Livonia is the first between the two schools this season.

Northville will then host Novi Saturday at 7 p.m. Turner doesn't believe his team's recent losing



**Kelly Bingley sets for a free throw in Friday's game.**

Photo by AL WARD

Last week's game with Farmington Hills provided a test for Northville's new offensive and defense.

"We've been staying positive," he added. "But this is a big week for us emotionally."

## Spiked

### Northville falls to Canton in four games

**By SCOTT DANIEL**  
Sports Editor

It's one thing when a team isn't up to the challenge of its rival.

It's quite another when officials aren't up to the task of doing their jobs properly. Strong words, but perhaps appropriate in the case of Northville High's volleyball match with Canton Jan. 15.

Playing at home the Mustangs fell in four games to Canton. According to coach Laura Murray, however, the match was ruined for both squads by poor officiating.

"The officials had a complete lack of knowledge of the sport," she said. "They didn't know the game. It was an injustice to the players."

Missed calls, continuous delays and arguments with players and coaches kept the four games going for more than two hours.

"The kids lost focus," Murray said. "It was an unfortunate loss to a team that is beatable for Northville."

The coach said Canton was a small team that focused mainly on defense and solid serving. With better hitting the Mustangs likely would've beat the Chiefs.

The absence of setter Danielle Jaskot may explain why Northville didn't hit better. She missed the match with a badly sprained finger suffered in a match with Walled Lake Central a few days earlier.

With Jaskot out, Murray was forced to change her lineup. She ran a two-setter offense with Kelly Golec and Lauren Metaj hoping to make up for Jaskot's absence.

"We didn't run as smoothly," Murray said. "Our sets were further off the net."

Canton dominated game one to the tune of 15-4. Murray said it took awhile for her team to get used to running the new style of offense. Hitting errors also played a part in the loss.

Northville rebounded for a 15-10 win in game two.

The two teams were actually tied at 10 before the Mustangs took command. Golec served for the final five points and notched a pair of aces.

She added four setting assists in the game. Karla Fortalso also played well with a pair of kills.

Northville tried to play catch up in the final two games but couldn't.

Canton took game three 15-7 and then the match

"The officials had a complete lack of knowledge of the sport. They didn't know the game. It was an injustice to the players."

with a 15-11 victory in game four.

Five serving errors and nine hitting errors were the story of a line three. Northville made just as many mistakes in both categories in game four.

Despite the loss, strong performances were turned in by several Mustangs.

Ananda's DeVoker had five kills and six digs while Golec had 15 assists. Tara Driscoll played good defense and totaled 14 digs. Metaj contributed to 13 kills and seven assists.

**CENTRAL def. Northville**

Walled Lake Central visited Northville on Jan. 13 and took an easy three-game victory.

Injuries killed the Mustangs.

Jaskot was hurt in game two trying to block a Becky Cummings smash. Ashley Osoola, Northville's top hitter, twisted an ankle in game one and couldn't return.

Murray said the injuries were unfortunate. A healthy squad might have been able to surprise Central.

"They are still a ranked team," she said. "But they're definitely a different team than last year. They don't have the fire power they had."

Walled Lake won the first two games 15-5 then closed the match with a 15-11 victory in game three.

The injuries took the wind out of her team's sails, Murray said.

"It made a big difference," she added.

The coach said her team must improve defensively to beat teams like Central and Canton.

"We're a good offensive team," Murray commented. "But not good defensively."

Continued on 9

MUSTANGS OF THE WEEK

BRIAN GRIDER - Wrestling
A junior co-captain, Grider had an outstanding week for the Mustangs. At the Brighton team Invitational he went 5-0.

MISSY MACRAE - Gymnastics
The freshman had an outstanding day at the Hartland Invitational Saturday. On the balance beam, MacRae was the champion with a 9.3 performance.

MUSTANG ROUNDUP

BASKETBALL

Friday - Northville @ Livonia Churchill (7:30 p.m.)
Saturday - Novi @ Northville (7 p.m.)
Tuesday - North Farmington @ Northville (7 p.m.)

WRESTLING

TODAY - Northville @ Harrison (6:30 p.m.)

VOLLEYBALL

Monday - Northville @ Livonia Churchill (7 p.m.)
Wednesday - Walled Lake Western @ Northville (7 p.m.)

SWIMMING

Tuesday - Northville @ Livonia Franklin (7 p.m.)

GYMNASTICS

Monday - Northville @ John Glenn (7 p.m.)

SCOREBOARD

WRESTLING

103 POUNDS
Jag (Novi) ..... 20-4
Cozart (Howell) ..... 6-3
Bordenkircher (Brighton) ..... 15-8
Ashby (Northville) ..... 8-5

112 POUNDS
Torrence (Northville) ..... 17-1
Kowal (Hartland) ..... 18-4
Secco (Brighton) ..... 10-3
Smith (Howell) ..... 9-7
Sirzakowski (Fowlerville) ..... 10-9

119 POUNDS
Williams (Howell) ..... 21-0
Sriraman (Northville) ..... 13-1
Cowan (Pinckney) ..... 18-5
Bair (Howell) ..... 16-6
Cushner (Brighton) ..... 13-8
Loomis (Fowlerville) ..... 4-3

125 POUNDS
Tnerweiler (Howell) ..... 20-4
Ferich (Fowlerville) ..... 14-6
Dorenzo (Hartland) ..... 19-9
Saran (Northville) ..... 12-7

130 POUNDS
Christoff (Novi) ..... 18-2
Mahe (Howell) ..... 18-7
Glynn (Hartland) ..... 20-9

Wade Dana (Fowlerville) ..... 8-7
Scott Lambert (Brighton) ..... 7-7
Keith Wood (Brighton) ..... 3-3

135 POUNDS
Steckroth (Hartland) ..... 18-4
Churella (Novi) ..... 13-5
Paul Gienapp (Brighton) ..... 15-6
Long (Hartland) ..... 15-7
Trierweiler (Howell) ..... 11-6
Call (Fowlerville) ..... 12-9

140 POUNDS
Lusk (Hartland) ..... 23-8

145 POUNDS
Watanabe (Novi) ..... 18-0
Graybeal (Hartland) ..... 27-2
Anzila (Novi) ..... 17-7
Wellman (Fowlerville) ..... 11-5
Ferich (Fowlerville) ..... 9-6
Kenney (Brighton) ..... 10-8

152 POUNDS
Seitman (Fowlerville) ..... 10-2
Dukes (Howell) ..... 13-4
Wendt (Novi) ..... 9-7
Glynn (Hartland) ..... 12-11
Knight (Fowlerville) ..... 3-2

160 POUNDS
Frost (Hartland) ..... 29-1
Becker (Novi) ..... 24-1

Hicks (Fowlerville) ..... 23-3
Miller (Brighton) ..... 7-4
Canady (Fowlerville) ..... 7-7

171 POUNDS
Rochowiak (Pinckney) ..... 26-1
Grider (Northville) ..... 16-2
Culver (Howell) ..... 17-3
Wellman (Fowlerville) ..... 7-5
Showerman (Fowlerville) ..... 12-8
Kish (Hartland) ..... 8-6
Craven (Hartland) ..... 11-9

189 POUNDS
Kuzinski (Hartland) ..... 26-0
Arnold (Howell) ..... 18-4
Plecha (Novi) ..... 14-6
Sheehan (Pinckney) ..... 18-7
Blair (Fowlerville) ..... 4-4

215 POUNDS
Jones (Pinckney) ..... 20-1
Evans (Brighton) ..... 20-2
Schyck (Hartland) ..... 22-4
Tabbot (Novi) ..... 17-8

HEAVYWEIGHT

Keilor (Brighton) ..... 20-2
Peyser (Hartland) ..... 22-6
Shue (Howell) ..... 15-9
Faulkner (Novi) ..... 13-8
Cooke (Pinckney) ..... 11-7
Nelson (Fowlerville) ..... 9-9

VOLLEYBALL

AREA LEADERS

KILLS
Horgan (Brighton) ..... 93
Malthaner (Brighton) ..... 93
Woblink (Pinckney) ..... 93
Derosia (Pinckney) ..... 68
Ossola (Northville) ..... 66

ACES

Piatek (Brighton) ..... 38
Dziekian (Brighton) ..... 24
Malthaner (Brighton) ..... 23
Ossola (Northville) ..... 17
Metaj (Northville) ..... 14
Driscoll (Northville) ..... 13

DIGS

Woblink (Pinckney) ..... 97
Cook (Pinckney) ..... 88
Jandasek (Brighton) ..... 85
DeKoker (Northville) ..... 79
Metaj (Northville) ..... 70

BLOCKS

Horgan (Brighton) ..... 52
Michaels (Pinckney) ..... 37
Shaw (Brighton) ..... 34
Poole (Northville) ..... 24

Tankers suffer first loss 113-73 to N.F.

By SCOTT DANIEL
Sports Editor

If the Mustang swim team had been a ship the past few weeks it would've been a destroyer.

Northville demolished three opponents and boasted a perfect record going into Thursday's meet at North Farmington.

"They're just a stronger team than we are this year," coach Mark Heiden admitted. "They were deeper than us throughout the meet."

As talented as North Farmington is, the coach doesn't believe Salem can be beaten in the WLAA.

"I don't think they'll challenge Salem," Heiden said. "They're not deep enough to challenge Salem."

North Farmington took command of Thursday's meet by winning three of the first four events.

Northville placed second in the 200 yard medley relay. The team of Craig Steving, Matt Schlanser, Chris Anderson and Steve Wiecksel posted a time of 1:51.47.

Evan Whitbeck won the 200-yard freestyle in 1:50.46 and brother David was fifth in 2:10.76.

In the 200-yard IM, Scott Whitbeck was second in 2:22.62 and Dan Milnes was fifth in 2:25.66.

A time of 2:21 was good enough for second place in the 50 yard

freestyle. Anderson was third in 2:41 and Wiecksel was fifth in 2:52.8.

In diving, Anderson finished first with 283.15 points and Dan Basse was fourth at 131.15. Chris Bond was third in the 100-yard butterfly in 1:04.36 and Craig Boyk was fifth with a time of 1:18.86.

In the 500-yard freestyle, Scott Whitbeck was second (5:33.9) and David Whitbeck was third (5:42.5). Wiecksel, Anderson, Milnes and Evan Whitbeck won the 200-yard freestyle relay (1:39.74).

Steving finished first in the 100-yard backstroke with a time of 57.54 and Adam Melvin was fifth in 1:11.78. Evan Whitbeck was first in the 100 yard breaststroke in 1:05.02. Schlanser was fourth in 1:14.05 and Brett Johnson was fifth in 1:16.73.

North Farmington won the 400-yard freestyle relay to close the meet. Northville was second with the team of Milnes, Bond, Steving and Evan Whitbeck (3:46.39).

Times for the Mustangs were a bit slower than in the past few meets.

Heiden said it wasn't because of the training his team had been doing before the meet. But the fact that it was finals week at the school may have been a factor.

Grapplers remain perfect in WLAA

Continued from 8

Saran (125), McCracken (160) and Giles (189).

NORTHVILLE 36 CHURCHILL 27

The Mustangs kept their perfect conference mark alive by edging Livonia Thursday.

Now 2-0 in the WLAA and the Western Division, Townsend said his team is a big threat.

"We have a good chance of winning the division," he said. Northville built a 27-0 lead and then hung on.

Ashby took a 7-2 victory at 103 pounds. Torrence and Sriraman then won by forfeit at 112 and 119.

At 125 pounds, Staples beat Dave Donnell 6-1. Saran won by forfeit at 130 pounds and Scappatucci defeated Mike Carter 2-0 at 135

pounds. A decision by McCracken (160 pounds) and a Grider pin clinched the victory.

Livonia made it close by sweeping the final four matches.

"They have strong upper weights," said Townsend

JUNIOR VARSITY Several JV Mustangs did well at the Garden City novice tournament Saturday.

Broken into ninth and tenth grade divisions, the Mustangs had several placers.

Matt Tarrow was fifth at 103 pounds in the sophomore division. Kevin Arbuckle won the 112 pound sophomore division, Tom Stimmel was sixth at 112 in the freshman division, Reggie Torrence was fourth at the 125 pound freshman division and Doug Smith was sixth at 130 pounds.

Cagers fall to Hawks

Continued from 8

defensive styles. The Mustangs used a zone to keep Harrison on the outside.

Turner said his team was able to rebound and cut guard penetration better playing the zone.

"I thought the adjustments we made were good," he added. "It's the best game we've played in three or four weeks. I was proud of the effort."

Offensively, the Mustangs were more patient.

"We're a team that shoots threes and drives," said Turner.

Four three-pointers helped Northville to a 27-23 halftime lead. Kelly Bingley nailed a triple at

the end of the second quarter to expand Northville's lead. Dave Terakedis, Luis Guajardo and Phil Kozdron each scored eight points in the half.

Harrison used its size advantage to wear Northville down in the second half.

Justin Snow, Brian Lewis and Matt Derocher took turns scoring inside. The trio accounted for more than half of Farmington Hills' points.

"I thought their inside strength hurt us," said Turner.

Guajardo led Northville with 15 points. Terakedis added 13 and Kozdron had 11. Kevin Bambanek led Harrison with 12.

DISCOUNT TIRE CO. CHEAP PRICES! BRAND NEW STEEL RADIALS! 4 FOR \$80, 4 FOR \$116, 4 FOR \$124. BFGoodrich Tires. MICHELIN. GOODYEAR. DISCOUNT TIRE CO. INC.



**REAL ESTATE**

**Expenses increase when school is over**

By James Woodard  
Copley News Service

When the kids graduate from high school they fly out of the nest, going to college or working. And that leaves the parents with more free time and less household expenses.

Right? Think again. It might surprise you to learn that over half (53 percent) of 18- to 24-year-olds are still living with

their parents. That increases the parent's household expenses by an average of 31 percent and limits their ability to acquire and move into a smaller or retirement home.

They also spend 69 percent more on vehicle insurance premiums, and almost three times as much on video rentals as they would if their adult offspring were off on their own. These facts and

Continued on 3

**HOME DESIGNS**



**Vera features a floor plan that assures privacy**

By James McAlexander  
Copley News Service

A wide lot is required to build the 1,926 square-foot Vera.

The configuration of this exciting new floor design has the isolated master suite on the left side of the house and the secondary bedrooms on the right. With the common areas in the middle, privacy is assured not only for the occupants of the master suite, but those in the other bedrooms as well.

This arrangement will be especially beneficial to a family with high-school students needing their own "space," or one with aging parents sharing the home.

Dignified columns frame the recessed entry and complement the attractive brick and siding exterior of the Vera. Once inside, the commendable use of the available space is evident throughout the entire residence. The expansive master suite includes - among its numerous amenities - a huge walk-in closet, raised television shelf and a private bathroom with twin basins.

This end of the house also contains a large storage area with access to the three car garage, and a handy utility room with a sink and built-in ironing board. Pull-down stairs in the garage take you up to an attic with an additional

480 square feet of storage capacity.

The up-to-date kitchen, easy to maneuver around in, features an island cooktop, walk-in pantry, appliance center, built-in desk and a bright breakfast nook. If the weather is agreeable, have your morning coffee on the adjacent covered patio.

The formal dining room with a beautiful built-in hutch, and the front living room, both have a coffered vault ceiling. When entertaining your guests in the comfortable living room, a combination gas/wood fireplace will keep everyone nice and cozy regardless of the conditions outside.

A skylit hallway leads to the secondary bedrooms. They are both good sized and have plenty of windows along with ample closet space. The smaller of the two has a built-in file cabinet, and with the addition of a desk and computer, can easily be converted for use as a home office. Nearby are two spots for linen storage and a full bathroom with twin basins.

For a study plan of the Vera (404 07), send \$10 to Landmark Designs, c/o HomeTown Newspapers, 323 E. Grand River, Howell, MI 48843. (Be sure to specify plan name and number when ordering.) For more information, call (800) 562 1151.

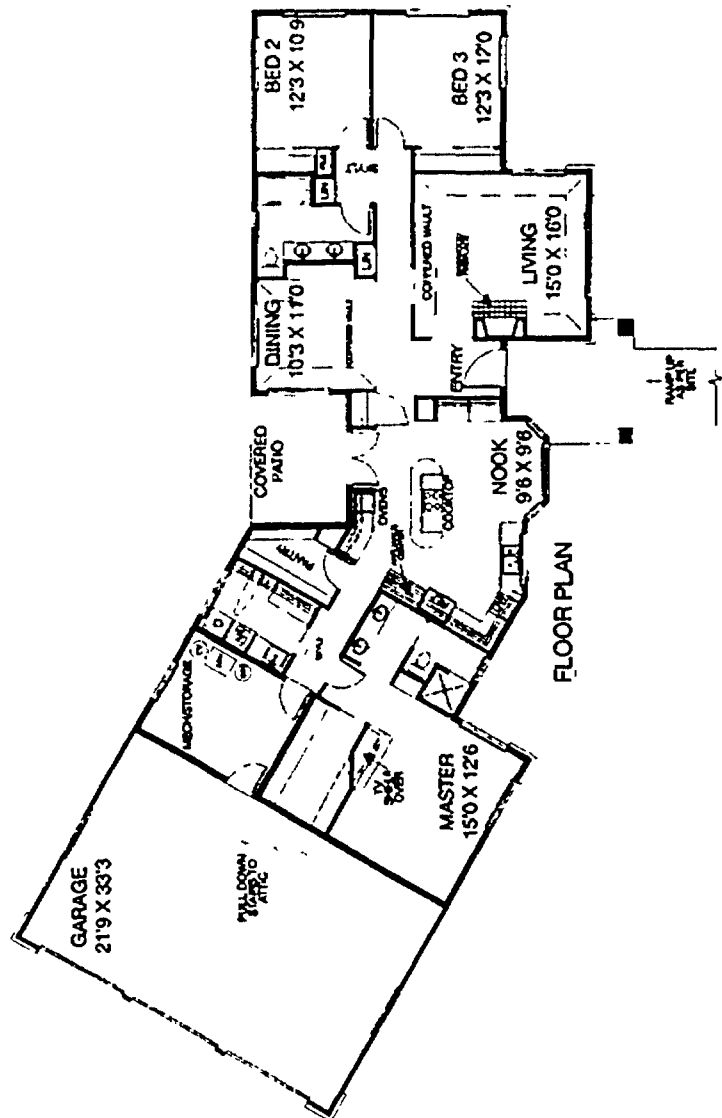

Jean and Ralph Rieker sit in their almost-complete Garfield Road home in Northville Township. They took ownership of the home 18 years ago, and have poured most of their time and finances into improving it. The fireplace behind them was made from stones taken from the gravel pit located directly behind their home.

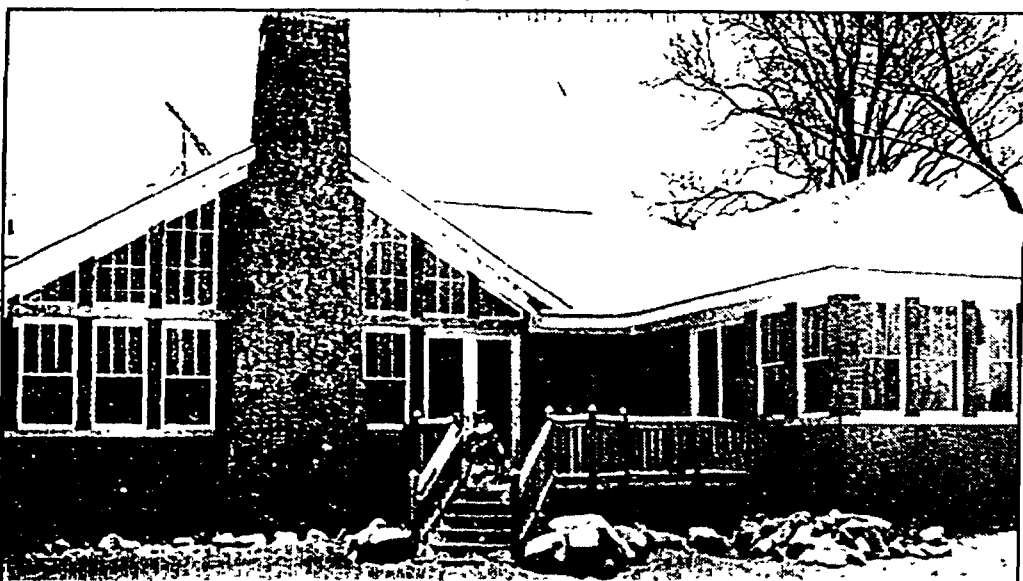

Stones used in the home's addition were manufactured and have true insulation value.

**A  
DIAMOND  
in the  
ROUGH**

It's as if the old red brick house had been waiting for just the right person to come along. Abandoned for 20 years, it needed to be nursed back to health.

Ralph and Jean Rieker saw the Novi home 18 years ago and knew it had potential.

The house was built in 1917 in what the Riekers call the "arts and crafts style" common in the 1920s, where the homeowners did a lot of the work themselves.

The original homeowners had seven children. The father, who was a brick layer, brought home reclaimed bricks which his children cleaned one by one. The bricks were then added to the outside, turning the white frame wooden home into its present red brick exterior. They also built the red oak staircase railing, bookcases and the mantel in the living room.

When the Riekers bought the four bedroom home, all the windows were broken, the plaster walls had to be replaced, and it needed new plumbing, electrical and heating systems.

"The basics are here, the house is sound," she said.

The 2,200 square foot addition to the back of the home has oak floors throughout and includes a master bedroom with a walk-in closet and a bathroom with a ceramic floor and two-way fireplace. Also included are a portrait-style Kohler Jacuzzi, and a Euro shower with multiple shower heads and water closet.

There is also a first floor laundry, guest bedroom and bathroom, which has Revival-style fixtures.

Because the Riekers could not find any bricks for the exterior of the addition which blended with the reclaimed brick used some 70 years earlier on the front of the home, man-made oblong pieces of cement which are hand chiseled to look like limestone were used with randomly placed fieldstone.

The floor-to-ceiling fireplace in the

Continued on 3

Story by Carol Workens  
Photos by John Heider

**Save your garden from wiley chipmunks**

By C.Z. Guest  
Copley News Service

**GARDENING**

9. Chipmunks keep taking small bites out of my tomatoes and other vegetables from my garden. I've tried everything including human hair, soap spray, netting, etc. To no avail.

Last summer I trapped about 40 chipmunks and released them in a wooded preserve about 10 miles from my property. This year, I see more of them and they look just as hungry. Will this ever stop? Do you have a solution?

A. I know this will amaze you, but here goes. You're probably trapping the same chipmunks over and over again! ABC Humane Rescue in Arlington Heights, Ill., suggests taking the trapped chipmunks at least 20 to 40 miles away to a rural area for release. Five or 10 miles is simply not far enough. However, trapping is the best way to go, and I suggest Sherman live traps (the same traps for moles). The traps you need are 3 inches by 3 inches by 10 inches.

Sherman traps are most effective when you position them so that the entrance

looks like a natural cavity - for example, poking out of a leaf pile. Chipmunks hunt by smell and, of course, they are very curious. A good bait is a mixture of greasy peanut butter, oatmeal and something fruity. Other delicacies they enjoy include beans, acorns, nuts, peas, raspberries and blackberries.

If your dogs and cats are good hunters, maybe they can control these rascals. My dogs, unfortunately, are no good at this type of hunting because they are large - too large for the tiny spaces chipmunks can fit into.

To successfully fence these devils out, you have to enclose your entire garden with a 6-foot fence made from one-quarter-inch mesh hardware cloth, sunk at least a foot into the soil (so chipmunks can't dig under it) with plastic bird netting across the top from side to side.

Two no-no's: Never use mothballs, mothflakes or any form of this extremely toxic substance in your garden or

**Controlling chipmunks**



■ Trapping is the best method of control. Sherman traps are effective and work best if they mimic a natural cavity, e.g. protruding from a leaf pile, etc. Bait the traps with peanut butter, oatmeal and fruit. Beans, acorns, nuts, peas, raspberries and blackberries are good choices, too.

■ Once trapped, try to move the chipmunks 20 to 40 miles from your garden and release them in a rural area.

■ Dogs and cats probably won't be very effective in the fight against chipmunks.

■ Fencing can keep chipmunks

out, but the fence must be of 1/4-inch wire mesh, 6 feet tall, sunk 1 inch into the ground and have plastic bird netting across the top.

■ Do not use mothballs - pets may eat the balls. Consider putting out water or a birdbath. This may quench the thirst of squirrels and chipmunks, thereby keeping them out of tomatoes.

■ Address for Sherman traps: H.B. Sherman Traps Inc., P.O. Box 20267, Tallahassee, FL 32316.

Continued on 2







CLASSIFIEDS

To place an ad call one of our local offices (313)913-6032 (517)548-2570 (810)437-4133

24 Hour Fax (810)437-9460 1-800-579-SELL

Deadline: Creative Living plus Fowlerville, Hartland and Pinckney Shoppers Fri 3:30 p.m. Creative Living Mon. 3:30 p.m. Published In: Country Living, Fowlerville Shopper, Hartland Shopper, Pinckney Shopper

Over 50,000 circulation every week

Index table listing real estate categories such as Homes, Open Houses, and various locations like Brighton, Canton, etc.

Hours: Tuesday - Thursday 8:30 a.m. to 5 p.m. Monday & Friday 8:00 a.m. to 5 p.m. Rates: 3 lines \$8.96 Each additional line \$2.19

Top Listers for December 1996 Northville/Novi Office Kathy & Jamie Chobot (810) 348-6430 Real Estate One 1045 Novi Rd. - Northville

300-498 REAL ESTATE

303 Open Houses: Hartland Schools OPEN SUN., JAN. 26, 2-4PM ALL YOU HAVE TO DO is move into this desirable quad-level in nice subdivision!

BRIGHTON SCHOOLS. (Lake Privileges) Only \$7,900 down payment, \$1,127/mo. P.I., 4 br., 2 bath, quiet street, 8 3/4' APR 30/ yrs., 24 hour hotline. (810)220-8599 Prudential Pre-view Properties.

BRIGHTON/LIVINGSTON COUNTY, FREE list of properties w/ prices, descriptions & addresses. Help-U-Sell, (810)229-2191.

BUILDERS OWN home. Late 1995 construction. Contemporary story & 1/2 2300 plus sq ft. Master br., laundry on first floor, 3 br., upstair, 3 1/2 bath, daylight bsmt, unfinished, maintenance free exterior on 2 1/2 wooded acres near GM proving grounds. Hartland schools. \$278,000 Call for appl. (810)685-3249.

HOWELL, 310 N. BARNARD, SAT, JAN. 25, 1-3pm. Fully restored Victorian, VRM - sellers will entertain offers. Minimum \$140,000 to \$150,000. Prudential Pre-view Properties. Joette Bakel, (810)220-1427.

OPEN SUNDAY 2-3:30pm. New construction in Brighton on Rickett Rd., just W of US 23 and S of Lee Rd. From \$164,900 to \$174,900. 17102, 17103, 17104. Call Donna O'Hara The Michigan Group. (810)227-4600, ext. 270

WALLED LAKE-BY OWNER Open Sun., Jan. 19, 11-6pm 671 Ridge, Maple & Decker, (W of Haggerty) 3 bedroom, 2 bath, 1st floor laundry, 2 car attached garage, alarm, marble floor, fireplace, ceramic kitchen, vaulted ceilings, central air. Close to schools, shopping & 1-696 \$182,000. (810)624-1940

WHITMORE LAKE, Open Sun. 1-4, 11555 Main Street N North of 8 Mile East of US-23 New construction contemporary ranch, CO#1261, \$169,900 Coldwell Banker, Brighton, Town & County. (810)227-1111

306 Brighton: BRIGHTON, CHARMING spotless 2250sq.ft., 9 lots, 100 yards from beach, 3-4 br., finished walk-out Open House, Sun. 12-3pm, \$169,900. Call Judy at (810)227-9506

307 Byron: 3 BR., garage, bsmt, 30x40 barn, 11 mi. N. Howell. \$125K. 5 poss. 10 acres. (810)266-5805.

308 Canton: CANTON STARTER home, 3 br. brick ranch. Built 1975. Priced much lower than other homes in sub, \$103,000. (810)449-8062.

315 Fenton: SULLIVAN LAKEFRONT contemporary Cape Cod built in 1980. All amenities. 2000 sq ft. plus finished walkout. Gorgeous home with fireplace in kitchen. 3 car, 2 story garage. \$199,900 Rose Realty (810)887-2728

316 Fowlerville: HOWELL AREA - Lovely 3 br. home on 1 acre w/pond. Fireplace. Full finished bsmt. 2 car garage. Possible rent while buying. \$875 per mo! \$151,900 Broker Office (810)735-1799 or (810)629-2599

ATTENTION CONTRACTORS! 2 yr. old home in need of repair, featuring 1650sq ft., 3br., 2 1/2 baths, on 2 acres. Will sacrifice at \$119,500 (517)223-4346

IOSCO TWP. Spacious 3 br, 1st floor laundry, 2 car attached garage, 2 1/2 acres wooded country setting Close to woods country setting Close to woods country setting Close to woods country setting

NEW HOME for sale. 1320sq ft., 3 br., 2 baths, formal dining rm., 1st floor laundry, 2 car attached garage, 2 1/2 acres wooded country setting Close to woods country setting Close to woods country setting

LOG HOME with lake privileges on all sports Chan of 7 Lakes. This great property features a full basement and enclosed porch \$34,500 REALTY WORLD VANS (810)227-3455

319 Hamburg: CONTEMPORARY ALL sport lakefront, 1200 plus sq ft. Ranch, very sharp Oversized lot. Under appraisal at \$144,754. Call Glen for appointment (810)684-6701 Coldwell Banker Galati, 211 E Commerce, Midford.

320 Hartland: HARTLAND SCHOOLS, Tyrone Twp Major fixer-upper on 5/2 acres, detached 3 car garage, horse barn with water & electricity 2 new paddocks \$94,900 (810)750-1654

321 Highland: ABSOLUTE BEAUTIFUL views from 1900 sq ft Sharp brand NEW all sport LAKEFRONT on 2 plus acres in Highland Twp. Horsemans OK, 3 br., large deck, fireplace, 2 car attached, 1st floor laundry, 2 1/2 bath, custom kitchen, walk-out bsmt. & more. Huron Valley Schools \$189,900 (810)889-5701

322 Holly: COMFY FAMILY home on 1/2 acre w/many improvements. Additional 3/3 acres available. HomeTown Realtors Inc (810)486-0006

323 Howell: 3 BR. ranch, walk-out, beautiful tree! 1 acre parcel, 2 1/2 car garage, paved road. \$137,000 Seller will look at all offers. Lavoie Realty (517)223-2273

4200 GOLF Club Rd., near Latson, 1,600sq ft., 2 car garage. \$127,000. (517)546-0134.

BY OWNER Newly remodeled, 3 br. ranch, all appliances included. Exc starter home. Conveniently located between Howell & Brighton. \$104,000 Call for appl (517)548-3590

324 Linden: MOTIVATED SELLER transferring out of area 2100 sq ft. 4 br., 2 1/2 baths, 1st floor laundry, full walk-out basement with 9th ceiling, 2 car garage, city water, city sewer. \$152,000 (810)735-1097

325 Livonia: COMPLETELY REMODELED 4 br colonial, 2 full baths, large country kitchen, 2 car heated garage, 1/2 acre lot, plus adjoining lot. \$137,900 Must see. Open Sun 1-5 (313) 458-3969

326 Milford: NEW 4 Br, 2 1/2 bath, colonial. 2576 sq ft., on 2 1/2 acres, poss LC \$225,900 (810)402-9262

329 Novi: BY OWNER, lg 4 br colonial, over 3000 sq ft., on 1/2 acre lot in Greenwood Oaks. Appraised at \$350K, selling for \$320K. (810)344-1977

CALL NOW for your buyer/seller advantage. SAVE THOUSANDS!!! Help-U-Sell (810)348-6006

MOVE IN now. Lovely historical home, lots of charm, lots of charm. Call for details. Only \$133,000 Code 15361 The Michigan Group, Marge McKenzie (810)227-4600 ext. 337, or (517)548-3174

FROM \$129,900 COMPLETE! Ranches, Cape Cods and Colonials, cathedral ceilings, 3 bedrooms, 2 baths, gourmet kitchens Township Water and Sewer

Wooded, walk-out, ravine lots available. Paved, curbed, winding streets, underground utilities, top rated Howell Schools Hickory Hills - EAST

Office: 1-800-360-9437 Models: 1-517-545-2980 Models Open 12 noon-6 pm daily

An Affordable Golf Course Community! Covington Greens

Over 1800 sq. ft. of living space. First floor master suite. Loft or third bedroom, overlooks spacious great room with fire place. Brick & limestone exteriors. Private chipping green and par (3) golf hole. For exclusive use of 68 residents. Entire project borders Faulkwood Shores golf course. Now accepting reservations for Spring '97 occupancy. Call "Steve" or Tom for your private tour and brochure. (810) 220-1515 or (810) 220-1510. Priced from \$169,900. ThePrudential

All Stars Will Steinmetz (810)229-8900

Model House Open Sat. & Sun. 1-5 or by Appointment 3 Homes Available Under Construction

ANN ARBOR from \$129,990 BUILDER'S CLOSE OUT! Traditional ranch and 2-Story Townhomes with Pond and Wooded Views

Hickory Hills - East by Welch Construction Company





# 1997 DINING CLUB CARD

# HomeTown Newspapers

**\$20** Membership includes  
1 Complimentary Entree  
with purchase  
at 30 local restaurants\*



**Your card to quality dining at affordable prices!**  
As a member of the HomeTown Newspapers Dining Club you'll enjoy restaurants that feature atmosphere from quaint and cozy to dancing and live entertainment. Your HomeTown Dining Club Card will pay for itself by using it one or two times. Dining Club Cards are a great gift idea that keeps giving the entire year. Stop in today and get your ticket to exciting culinary adventures at the 30 restaurants listed on this page.

\*Some restrictions apply, card effective January 2, 1997 thru December 30, 1997.

**Annie's Pot**  
Catering • Fine Dining  
2709 E. Grand River Ave.  
Howell

**517  
546-8930**

*Pizza and specials of the day excluded.*

**Appé  
teaser**

335 N. Main • Milford

**810  
685-0989**

Not valid 5pm-9pm  
Friday & Saturday.

**BOBARNSTORMER  
ROB BAR & GRILL**

9411 E. M-36 • Whitmore Lake

**313-449-2023**

• Weekly Drink Specials  
• Thursdays - Ladies Night  
• Fridays & Saturdays - 21 & over only  
• DJ Entertainment • Open For Dinner  
• Complete Banquet Facility

**BON-A-ROSE**  
Italian American  
**RESTAURANT**

56808 Grand River • New Hudson

**810-437-8788**

Hours:  
Lunch Only Tues., Wed, Thurs, 11-3,  
Lunch & Dinner Only Fri. 11-10,  
Dinner Only Sat 4-10

Value up to \$10.00 off second entree.

**BUM  
STEER**

*Happy Hour 2-7  
Mon-Fri  
\$1.95  
Bottle Beer*

*Live Blues  
Band Fri  
& Sat  
Nights*

An American Grill  
106 S. Lafayette • South Lyon  
(corner of 10 Mile & Pontiac Trail)

**810-437-4161**

Your Host Gary, Gary, Gary  
Dine in only Valid Sunday - Thursday  
Excludes holidays. Limit 1 card per table

**Cassel's**  
FAMILY RESTAURANT

Complete Carry-out Service

43261 W. Seven Mile Rd. • Northville  
Located in the Highland Shopping Center

**Homemade Specials for  
Breakfast, Lunch & Dinner!**

**810-348-1740**

Valid on dinner entrees only.

**CHAMP'S  
PUB**

Voted One of the Best Neighborhood Bars  
by Readers of AAA Magazine

Voted **BEST BURGERS** of  
Livingston County Since 1988

Hours:  
Mon-Fri 8am-1pm, Sat 9am-1am, Sun 9am-12am

140 E. Grand River • Brighton

**810-227-4443**

Valid Sunday - Wednesday

**CHOO CHOO  
DELICIOUS  
EXPRESS**

WALLED LAKE MICH.

1003 E. West Maple • Walled Lake

**810-669-5200**

Valid only Monday - Thursday after 4pm

**Country  
Pub**

Great Food & Spirits

150 Main St • Gregory

**313-498-2548**

HOURS:  
Sunday, Monday, Tuesday - 10:30am to Midnight  
Wednesday, Thursday, Friday, Saturday - 10:30am to 1am  
Not valid Friday 6pm-9pm

**Dam Site Inn**

4095 Patterson Lake Rd.  
Hell, Michigan

**313-878-9300 or  
313-878-3634**

**Half Price on Pizza -  
or, Two alike for One Price!**

Valid for food and in-house meals  
Pizza - half off total of 1.

**DEXTER'S** Pub on Main  
Street

8114 Main St.  
Dexter

**(313) 426-1234**

Hours: Mon-Thurs. 11am - 12am  
Fri. & Sat. 11am - 1am  
Sunday 12 noon - 10pm  
Serving Lunch & Dinner  
Outdoor Deck  
See restrictions.

**GARDEN SPOTS  
RESTAURANT**

Livingston County's largest  
salad bar, homemade soups,  
sandwiches, pastas and stir fry

Non-smoking environment

HOURS:  
Mon - Sat 10:30 - 8:00, Sun 10:30-3:00  
Brunch Served Saturday and Sunday

500 W. Main St • Brighton • **810-227-5214**  
Valid Monday - Thursday

**German  
Restaurant**

114 N. Center, Stockbridge

**(517) 851-7785**

Specializing In Traditional  
Home Cooked  
German & American  
Meals  
Closed Mondays  
See restrictions

**Gregory Inn**

Daily Luncheon and  
Dinner Specials

HOURS:  
Sunday - Thursday 7am-8pm  
Friday & Saturday 7am-9pm

144 Main St • Gregory

**313-498-2222**

Not valid Friday 6pm-9pm.

**Heidelberg  
Restaurant**

One complimentary entree  
(from regular or special menu)  
with the purchase of one other  
entree of equal or greater value,  
up to \$7.00 (seven dollars) and  
the purchase of 2 beverages.

215 N. Main St. • Ann Arbor

**313-663-7758**

**Key Largo  
Lakeside Grill**

142 E. Walled Lake  
Walled Lake

**313-669-1441**

One Lunch or Dinner with One.

**La Piñata**  
MEXICAN  
RESTAURANT

2204 W. STADIUM  
ANN ARBOR

**(313) 769-9277**

OPEN 7 DAYS  
CARRY-OUT AVAILABLE

Not valid during happy hour  
Mon - Fri 3 pm-6pm

**OL' CHOP**

Restaurant & Catering

"Let us Cater Your Special Events"

8485 W. Grand River  
Brighton

**(810) 227-5520**

Valid Monday - Thursday Dine in only

**Maples Seafood &  
Grille Restaurant**

31260 Wakefield Dr.  
Novi

14 Mile, 1 mi. W. of Haggerty Rd.

**810-669-6551**

Not valid on all you can eat  
specials.

**Mary's**

FABULOUS CHICKEN & FISH  
• Chicken • Fish • Shrimp  
• Steak Hoagies  
Perfect for Picnic & Parties  
Open 7 Days

2429 E. Grand River, Howell  
Grand River at Chilson

**517-548-3615**

Valid only on individual dinners. Valid on carryout.

**Memories**  
RESTAURANT & NIGHT CLUB

Dining, Dancing, Private Parties

1840 Old US 23 • Brighton

**(810)227-7230**

Open for lunch  
Mon. thru Fri. 11:00 am  
Valid Sun - Thurs.  
of equal or lesser value. Gratuity not included

**MEXICAN JONES  
RESTAURANTE  
AND LOUNGE**

PARTIES - COCKTAILS - BANQUETS

675 West Grand River  
Brighton

**(810) 227-2122**

Not valid 6-9 pm  
Fri & Sat

**DINNER TRAIN**

Michigan Star Clipper

• 5 Course Fine Dining  
• Murder Mystery & Musical Cabaret  
• 3 Hour Excursion • Year Round

• Also, OVERNIGHT B & B SLEEPER CARS  
• Reservations Required • Gift Certificates

Walled Lake

**810/960-9440**

In Walled Lake, a few short minutes north of  
Novi 1-96 east

\$20 value per couple. Reservations required no earlier  
than 7 days in advance. Valid Sun. - Fri. Not valid on any  
holidays, nor the month of December Expires 11-30-97.

**Mr. B's  
SOUTH LYON HOTEL**

Call for daily food &  
drink specials

HOURS:  
Mon. - Sat. 11-2am; Sun. 11-11pm

201 N. Lafayette • South Lyon

**810-437-6440**

**Murphy's  
Of Northville**

134 N. Center St. • Downtown Northville

**810-348-2660**

Breakfast, Lunch  
Friday Night Fish Fry  
32 Flavors of Guemsey Ice Cream

Valid anytime Monday - Friday;  
after 1:00 Saturday & Sunday.

**Paul's  
Family Restaurant**

102 S. Howell St. • Pinckney

**(313) 878-5630**

Open 7 Days  
Breakfast - Lunch  
Dinner

See restrictions

"Fast, Fresh, Wholesome Food for a Change"

**Santino's  
Place** for  
pasta

Carry Out & Catering

22200 Novi Road • Novi  
(in the Oakpoint Plaza)

**(810)380-3232**

Valid for Carry Out; Max \$5.00

**SHOOTERS**

NEIGHBORHOOD  
GRILL & PUB

Catering & Banquet Facilities

**(313) 426-1600**

11485 N. Territorial Road • Dexter  
2 miles west of Dexter Pinckney Rd

**The  
Links**

1111 Six Mile Rd. • Whitmore Lake

**(313) 449-4653**

Reservations requested - seasonal hours. Max.  
value \$12.00. Not valid for outings/banquets  
or special events.

**tios  
MEXICAN  
RESTAURANT**

333 E. Huron Street • Ann Arbor

**313-761-6650**

See restrictions



## Training workers in self defense

By ANNETTE JAWORSKI  
Special Writer

"Nobody thought about assault, until Dr. Iverson's murder. And nobody talks to their daughters about rape," said Jason Clarke of First Line Defense. For this reason, the senior instructor in rape attack prevention recommends his service.

First Line Defense specializes in rape attack and prevention through seminars, workshops and in-home instruction. Beginning Feb. 1, he will also be a regular feature at Vital Power Fitness Gym in South Lyon.

"You don't expect to get in an accident, but that doesn't stop you from buying auto insurance," says Clarke. He reasons that it makes sense to protect your most valuable asset, yourself, by learning methods of self defense.

The 1992 graduate of South Lyon High School is back in the area to share his knowledge. His goal is to help women learn self defense techniques with hands on experience. Most importantly, he provides a safe, non-threatening environment to learn and practice his techniques, including choke holds and joint manipulation. He doesn't believe in complicated maneuvers, but practical approaches to real life encounters.

Clarke sees his service as an opportunity for corporations to make an investment in their employees.

"Corporations need to realize they can only benefit from my service," he said. "I would like to provide my service for a corporation with a high percentage of female employees."

"What's the benefit to the client?" Clarke believes it's like learning

any other skill. It gives a great deal of fulfillment. It can be a great self-esteem booster and motivator. Higher self esteem translates into happier, more productive employees and lower employee turnover.

"It also sends a message that the employer cares about the employees' well-being," he said.

The types of training that Clarke presents gives immediate improvement with practice, which gives the student instant gratification.

One of his concerns is that frequently women feel a false sense of security with gadgets such as mace or weapons. It's another sobering fact that 90 percent of rape victims are familiar with their attacker, which he terms acquaintance rape. Acquaintance rape can be altogether different than date rape, he explains. Clarke identifies eight types of rapist in his program, and how to deal with them.

He believes awareness needs to be incorporated in self-defense training. For this reason, Clarke feels his service can be a tremendous benefit to schools, both junior high and high school. He suggests teaching self-defense in addition to sex education at those levels. He was recently a featured speaker at South Lyon Middle School.

In addition to physical maneuvers, Clarke teaches what he calls deception techniques. For example, how to keep a date situation from escalating into danger, or how to talk your way into an opportunity to escape. He talks about practical ways to protect yourself from a stalker.

His interest in self defense began when he was 7 years old.

"When I was 7, I used to take all my allowance and spend it on



Jason Clarke of First Line Defense discusses a attack prevention with a class from South Lyon Middle School.

Photo by HAL GOULD

learning martial arts," Clarke said. "I wanted to be able to fly through the air and kick five people before I touched the ground," he laughs.

He's spent a lifetime learning four different kinds of martial arts, along with hand-to-hand combat techniques while in the military service. He credits his current personal trainer, Don Daly, from Fitness Solutions in Novi for his

physical conditioning.

His qualifications also include certification as a Recognized Instructor from the Rape Awareness and Prevention Organization, or RAP, where he has been trained and certified in their specialized course of study.

He hopes his service will clarify some of the misconceptions about martial arts, such as the belief that

it's an aggressive sport or hobby for black belts only.

"The problem is that a lot of people look at martial arts as a hobby and not life insurance," he said.

Jason Clarke's services through First Line Defense can be sched-

uled by calling 810-685-7198.

He will also hold regular sessions beginning Feb. 1 at Vital Power Fitness Gym located at 22886 Pontiac Trail, contact them at (810) 486-5550 for scheduling information.

### RAISE YOUR HOUSE

- Basements
- Foundations
- Underpinning
- Floor Leveling
- Remodeling
- New Construction



UNDER YOUR HOUSE IS MY SPECIALTY  
LICENSED & INSURED  
**GARY SPARKS CONSTRUCTION**  
363-2967

### We Buy & Sell Used C.D.s

Thousands of Used Books

Wendy's Books 960-1030  
1123 W. Maple M-F 10-8  
Walled Lake, MI Sat. 10-5

**Happy New Year!**

To all my valuable customers, friends & family. Hope you have a wonderful 1997. It's also a great time to buy a new or used vehicle! If you're looking for a deal, I've got plenty of them!

Your Buddy,  
James

**CHAMPION CHEVROLET-Geo**  
229-8800 or 545-8800

**South Lyon Fireplace Shop**  
Area's largest selection of glass doors and mantels

**Moving Sale**  
up to **50% Off**  
All Inventory

Glass Doors, Mantels, Gas Logs, Gas Stoves, Accessories  
Hours: Mon. - Fri. 10-6; Sun. 10-4  
**437-3044 / 437-0055**

228 S. Lafayette  
South Lyon  
2600 S. 27th St., Milford, MI 48150

It's That Time of Year Again!  
**The Detroit Auto Show Used Carpet Sale**

Variety of Styles and Colors

**\$1.95** sq. yd. to **\$6.95** sq. yd.

Friday, January 24th, 1997 8 am - 9 pm  
Saturday, January 25th, 1997 8 am - 9 pm  
Sunday, January 26th, 1997 12 pm - 5 pm

Trailers of Used Carpet unloaded daily

Padding as low as 99¢ sq. yd.

Must take carpet with you at time of sale. Installations can be set up at a later date. Our warehouse will be closed at 12:00 pm on January 22nd to get ready for this event, we will reopen Friday, 24th at 8 am. Only our Riverview location will be open Thursday January 23rd for this sale from 9 am - 9 pm.

**DONALD E. McNABB**  
CARPET COMPANY  
31250 S. Milford • Milford  
(810) 437-8146  
5 min. west of 12 Oaks Mall Exit 155 off I-96  
Open Mon.-Sat. 9 am-9 pm; Sun. 12 pm-5 pm

**McNABB CARPET WAREHOUSE OUTLET**  
18236 Fort St. • Riverview  
1/2 mile north of Sibley  
(313) 281-3330

Open 7 Days Now 2 Locations to serve you

Ladeez and Gentlemen, Step Right In! We Are Presenting

**500** Items Reduced 1/2 Price or more!

**THIS ONLY HAPPENS ONCE A YEAR!**  
Don't go away for the week!  
Don't miss it!  
Walk, run, use a bicycle, truck or snowmobile this Friday & Saturday we are going to have every piece of brand new furniture throughout our store marked at "USED PRICES."  
This is the BIG ONE  
The Sale that delivers what other sales only promise!

**TWO DAYS ONLY**  
**20 FANTASTIC HOURS**  
**FRIDAY & SATURDAY**  
**JANUARY 24 & 25, 1997**  
**9 AM TO 9 PM FRIDAY**  
**9 AM TO 5 PM SATURDAY**

**THE LARGEST GARAGE SALE**  
IN OAKLAND COUNTY

All Lamps 1/2 OFF  
NO HOLDS NO REFUNDS NO PHONE CALLS NO EXCHANGES  
All Richard Mattress Sets 1/2 Off  
Must sacrifice 57 QUALITY SOFAS  
Quantity limited

PLUS  
Huron Valley Furniture will take an additional 5% off on purchases of \$500 or more on 1-24-97 & 1-25-97 only!

**Huron Valley Furniture**

- We specialize in solid oak!
- Quality furniture at affordable prices!
- Free delivery and set-up!
- Visa and Mastercharge welcome!
- 90 days same as cash option with approved credit!

319 N. Main St., Downtown Milford















# THE NEW Hines Park



OF MILFORD

OPEN SATURDAY

# BIG EVENT!

'97 TAURUS GL  
4-DOOR SEDAN

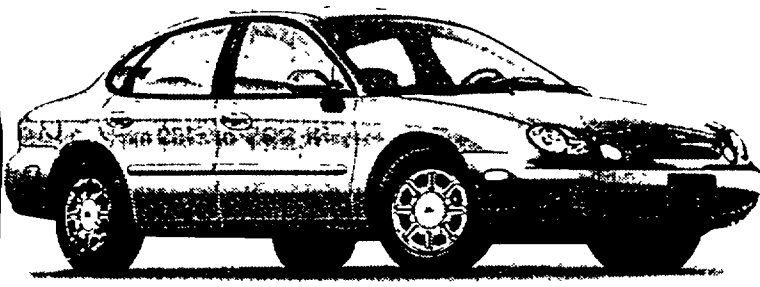

STK #70180C

INCLUDES:  
\$500  
RCL RENEWAL  
BONUS

- PREFERRED EQUIPMENT PKG. 205A
- SPEED CONTROL
  - FRT/REAR CARPETED FLOOR MATS
  - AM/FM STEREO RADIO
  - W/CASSETTE•POWER DOOR LOCKS
  - 6-WAY POWER DRIVER'S SEAT
  - WHLS, ALUM
  - LIGHT GROUP
  - 3.0L EFI V6 ENGINE
  - AUTO OVERDRIVE TRANSMISSION

\$2000 DOWN = \$187<sup>02\*</sup>  
\$1000 DOWN = \$233<sup>47\*</sup>  
\$0 DOWN = \$279<sup>91\*</sup>

66  
OTHERS AT  
SIMILAR  
SAVINGS

1997  
LEASE  
SPECIALS

ALL PRICES  
INCLUDE  
DESTINATION  
AND DELIVERY

FULL TANK OF  
GAS WITH  
EVERY VEHICLE  
DELIVERED

'97 F-150 SUPER  
CAB 4X2 PICKUP

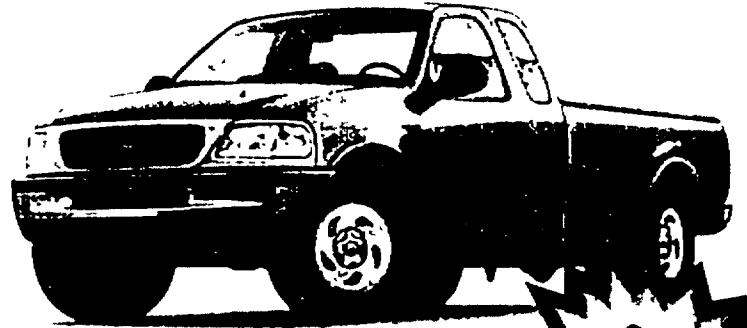

STK #70877R

- PREFERRED EQUIPMENT PKG 502A
- XL SERIES
  - CHROME REAR STEP BUMPER
  - 4 2L EFI V6 ENGINE
  - 5-SPD MANUAL O/D TRANS
  - P235/70R-16 OWL ALL-SEASON
  - 3.55 RATIO LIMITED SLIP AXLE
  - XL SPECIAL APPEARANCE PACKAGE
  - CHROME STYLED STEEL WHEELS
  - LOWER TWO-TONE PAINT

GREAT  
FAMILY  
VEHICLE!

- FLOOR CARPET
- SLIDING REAR WINDOW
- SPD CONTROL/TILT STEERING WHL
- BLACK AERO MIRRORS
- AIR CONDITIONING -- CFC FREE
- AM/FM ELECT STEREO CASS CLOCK

52  
OTHERS AT  
SIMILAR  
SAVINGS

\$2000 DOWN = \$167<sup>48\*</sup>  
\$1000 DOWN = \$214<sup>24\*</sup>  
\$0 DOWN = \$261<sup>00\*</sup>

## FIT THESE IN YOUR BUDGET!

'97 RANGER  
4X2 XLT  
22 others at similar savings

WOW!

\$2000 DOWN = \$87<sup>71\*</sup>  
\$1000 DOWN = \$134<sup>47\*</sup>  
\$0 DOWN = \$181<sup>23\*</sup>

'97 ESCORT LX  
4-DOOR  
30 others at similar savings

WOW!

\$2000 DOWN = \$137<sup>17\*</sup>  
\$1000 DOWN = \$182<sup>68\*</sup>  
\$0 DOWN = \$227<sup>78\*</sup>

'97 CONTOUR GL  
4 DOOR SEDAN  
27 others at similar savings

WOW!

\$2000 DOWN = \$137<sup>18\*</sup>  
\$1000 DOWN = \$183<sup>10\*</sup>  
\$0 DOWN = \$229<sup>03\*</sup>

'97 WINDSTAR  
GL WAGON  
17 others at similar savings

INCLUDES:  
\$500 RCL  
RENEWAL  
BONUS

\$2000 DOWN = \$228<sup>47\*</sup>  
\$1000 DOWN = \$273<sup>98\*</sup>  
\$0 DOWN = \$319<sup>49\*</sup>

'97 VILLAGER  
GS WAGON  
32 others at similar savings

INCLUDES:  
\$500 RCL  
RENEWAL  
BONUS

\$2000 DOWN = \$196<sup>78\*</sup>  
\$1000 DOWN = \$242<sup>49\*</sup>  
\$0 DOWN = \$288<sup>21\*</sup>

\*24 month closed end non maintenance lease to qualified customer. Add 6% use tax for total monthly payment. ALL PAYMENTS INCLUDE DESTINATION CHARGES. Payments based on 12,000 miles per year. (15¢ excess miles) All manufacturer's incentives are figured in lease payments and assigned to dealer. Lessee has option to purchase at lease end for price determined at lease inception. Lessee is not obligated to purchase at lease end. Lessee is responsible for excess wear and tear. Refundable security deposit (payment rounded up to next \$25). First payment, customer down payment, 6% use tax, luxury tax (if applicable), title, and license fees due at inception. Payments x24 equal total payments. RCL rates authorized by Ford Motor Company subject to change without notice.

**SALES HOURS**  
Open Monday and Thursday  
8:30 am 'til 9 pm  
Tuesday, Wednesday and Friday  
8:30 am 'til 6pm  
**SATURDAY 10:00-3:00**

130 SOUTH MILFORD RD., MILFORD  
**(810) 684-1715** OR  
Toll Free **(888) 440-FORD**

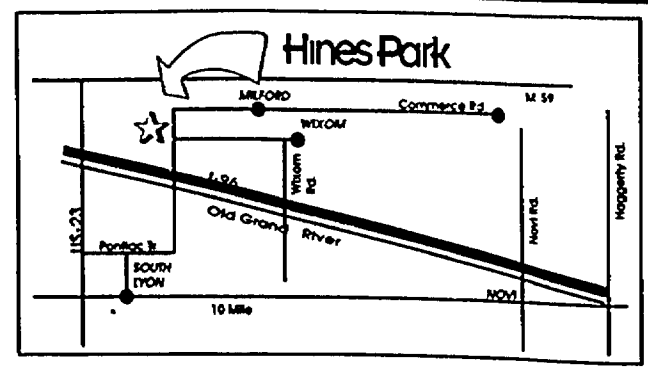

# CHAMPION

## USED CAR CONNECTION

Thursday, January 23, 1997—GREEN SHEET EAST—9D

More than just a great price!

**Certified Sales Consultants**  
All Champion sales consultants undergo an intensive training program to deal with customer's needs successfully, always keeping budget concerns in mind.

**Easy On-Site Financing**  
Champion provides easy on-site financing with 15 accredited lending institutions to choose from and terms and payments tailored to fit your needs.

**Warranty On All Vehicles**  
All vehicles under 100,000 miles and less than ten years old are covered by an extensive warranty. See dealer for details.

**52-Point Mechanical Inspection**  
All vehicles undergo a rigorous 52-point inspection by factory trained, state certified, authorized technicians before going on sale.

**Low Down Payments & Monthly Payments**  
Champion certified sales consultants work with you to arrange affordable down payments and monthly payments.

**Poor Credit History?**  
Champion says "Yes" when others say "No". Credit specialists provide fresh-start financing despite divorce, layoff or other past problems.

**BAD CREDIT? BANKRUPT?**  
1. You must be employed.  
2. Have a trade or down payment.  
IT'S EASY, IT'S FAST!  
810-229-8800  
517-545-8800  
Ask for Dave Gabel  
Phone Applications Accepted

**GM Certified USED VEHICLES**

Vehicles that carry this label meet GENERAL MOTORS standards, including 110 point appearance & servicing inspection & reconditioning, vehicle history & campaign check, market based NO HAGGLE pricing, a customer friendly sales environment, a 12/12 GM Certified Used Vehicle limited warranty, including roadside assistance, and a 3 day/150 mile money back guarantee!

**ASK ABOUT OUR "0" DOWN LEASE PROGRAMS!**

**LOT CHAMPION CHEVY-GEO**  
**#1 MAIN LOT USED CARS**  
Grand River at I-96 bet. Howell & Brighton  
517-545-8800  
810-229-8800

**LOT BRIGHTON USED CARS**  
**#2**  
603 W. Grand River, Brighton, MI  
810-229-8800

**HERE'S A SAMPLE OF OUR 350 VEHICLES AVAILABLE!**

'92 ESCORT Automatic & air low miles! \$4,977 or '96 mo.	'94-'96 CAVALIERS 5 spd & auto, incl RS 2 dr, 4 dr many with low miles! FROM \$5,999 or '104 mo.	'95 CARAVANS & VOYAGERS 7 passenger many with low miles & V6's, some with oil new current warranty! FROM \$11,299 or '185 mo.
'93-'95 GEO METROS Fantastic gas mileage SUPERSTORE SELECTION! From \$2,999 or '52 mo.	'95 S10 LS EXT. CAB Very low miles, oil new truck warranty, 4.3L V6, no AC, truck case, extra power windows & locks etc! \$12,499 or '205 mo.	'95 GRAND AM GT Auto, V6 AC loaded! \$11,488 or '189 mo.
'89 AEROSTAR 7 passenger low miles call for details! \$3,477 or '93 mo.	'93 1500 PICKUP Runs & looks great, ready for work! \$8,488 or '148 mo.	'94-'96 S10 & RANGER PICKUPS 5 spd & auto, 2WD & 4x4, reg cab & ext. cab, many with low miles! FROM \$7,477 or '130 mo.
'91 TEMPO Automatic & air low miles! \$3,988 or '84 mo.	'95 TAURUS Auto, V6 AC loaded! \$9,499 or '156 mo.	'93-'95 CADILLACS Oldies & Fleetwood Broughams, many with low miles & oil new car warranty! FROM \$12,977 or '227 mo.
'95-'96 1500 & 2500 PICKUPS Buy & Sell Cars, Chevrolet & Long beds, 2WD & 4x4, many with 30000+ Chevrolet and 27100+ GM oil new miles & oil new truck warranty! CALL FOR DETAILS!	'94 ASTRO EXTENDED MINIVAN 7 passenger loaded incl remote keyless entry! \$9,977 or '173 mo.	'95-'96 BLAZERS/JIMMYS, 4X4's 2 or 4 dr loaded auto AC 4.3L V6 many with low miles & oil new truck warranty! FROM \$18,988 or '313 mo.
'95 1500 PICKUP Auto & AC low miles incl bedliner extra clean! \$11,477 or '189 mo.	'92 SUNDANCE Low miles includes air! \$4,299 or '83 mo.	<b>CAN'T FIND WHAT YOU'RE LOOKING FOR HERE?</b> We have way, way too many to list! WE PROBABLY HAVE IT! CALL US TODAY & SAVE!
'90 F150 XLT-LARIAT V8 with air, low miles! \$5,488 or '148 mo.	'96 RANGER-SPLASH Very low miles like new, but new truck warranty incl chrome wheels! \$10,988 or '181 mo.	<b>ASK ABOUT OUR 0 DOWN/NO PAYMENT FOR 90 DAYS!</b>

**SUPERSTORE CAR, TRUCK, MINIVAN, 4X4, & SPORT UTILITY SELECTION**

'96 CORSICAS 10 to choose from, all low miles, starting at \$10,995 or '182 mo.	'86 BUICK REGAL T-TYPE Last of true muscle cars! Loaded, power roof, must see! \$7,995 or '224 mo.	'93 CADILLAC SEDAN DEVILLE Super nice car, white/white leather \$13,995 or '299 mo.
'95 GMC JIMMY 4 DR 4x4 Loaded 10 to choose from, must see \$18,995 or '348 mo.	'94 CHEVY S-10 PICKUP 4x4 Super nice, loaded, purple \$14,995 or '289 mo.	'92 LINCOLN CONTINENTAL 4 DR Very nice, loaded \$7,995
'94 GMC JIMMY 4 DR 4x4 Red, SLE, low miles, must see \$17,995 or '355 mo.	'94 PONTIAC GRAND PRIX SE 4DR Loaded, like new, only \$13,995 or '267 mo.	<b>Credit Problems? We can help.</b> No credit problem too big. No Hassle credit approvals 810-227-1550 Ask for Tony
'94 CHEVY S-10 PICKUP Teal low rider very nice only \$9,995 or '179 mo.	'95 DODGE VOYAGER CARAVANS All low miles, 10 to choose from, starting at \$12,995 or '230 mo.	'92 CHEVY CAMARO R.S. Teal, loaded, super nice, be ready for spring \$9,995 or '222 mo.
		'94 DODGE INTREPID Loaded, teal, sharp, car, only \$10,995 or '201 mo.
		'95 & '96 NEONS 4 to choose from, 20's & 22's, all low miles, starting at \$185 mo.

**LOT HOWELL USED CARS**  
**#3**  
904 E. GRAND RIVER, HOWELL, MI  
Across from Bowl-A-Drome at Grand River and National  
1-800-800-6930

'94 RANGER SPLASH Low miles, priced to sell \$10,895 or '199 mo.	'94 DODGE CARAVAN 7 passenger van, auto, air, cassette, V6 \$11,765 or '215 mo.	'96 PONTIAC GRAND AM 2 DR GT Bright red, brand new \$15,995 or '250 mo.
'94 FORD F-150 Auto, V6, cruise, tilt & more \$11,876 or '205 mo.	'88 FORD BRONCO II 4x4 Runs great, only \$3,595	'94 CHEVY S-10 Low rider, tonneau cover, low miles \$9,995 or '199 mo.
'96 OLDS ACIEVA 4 DR Equipped for you, auto, air, cassette window locks \$10,985 or '199 mo.	<b>Credit Problems/No Problem ALL APPLICATIONS ACCEPTED</b> 2 E 2 Qualifications 1 Must be employed 2 Have a trade or down payment Call 1-800-800-6930	'92 CHEVY SUBURBAN 4x4 3rd seat, loaded \$16,595 or '359 mo.
'96 CHEVY MONTE CARLO Leather, low, low miles, luxury for sports car enthusiasts \$18,965 or '298 mo.	'92 FORD ESCORT 4 DR Auto, fits any budget \$4,995 or '125 mo.	'93 FORD F150 Long bed w/cap \$8,995 or '189 mo.
'95 CHEVY CONVERSION VAN Take the family in comfort \$17,865 or '289 mo.	'95 JEEP WRANGLER 4x4 Convertible \$14,995 or '249 mo.	'92 CAMARO RS Teal, auto, V8, loaded, w/1-tops \$9,995 or '209 mo.
		'92 PLYMOUTH SUNDANCE Perfect for every budget \$5,495 or '149 mo.

**NEW AND EXCITING FOR 1997!!**

<b>1997 LUMINA</b> Stock #1714 Was \$19,164 Now <b>\$16,603</b> OR <b>\$269</b> Per Month	<b>1997 MALIBU</b> Stock #1733 Was \$18,173 Now <b>\$15,985</b> OR <b>\$254</b> Per Month	<b>1997 CAVALIER</b> Stock #1750 Was \$14,136 Now <b>\$12,497</b> OR <b>\$219</b> Per Month
<b>1997 BLAZER 4X4</b> Stock #6364 Was \$28,111 Now <b>\$24,865</b> OR <b>\$319</b> Per Month	<b>It's Back</b> <b>3.9% APR</b> AVAILABLE UP TO 6 MONTHS On Selected Models Now through January 31, 1997	<b>1997 C-1500 PICKUP</b> Stock #6307 Was \$18,341 Now <b>\$15,795</b> OR <b>\$248</b> Per Month
<b>1997 C-1500 EXTENDED CAB</b> Stock #6447 Was \$21,564 Now <b>\$18,402</b> OR <b>\$229</b> Per Month	<b>NEW SUBURBANS &amp; TAHOES</b> Starting as low as <b>\$27,950</b> Mid Michigans #1 Suburban & Tahoe dealer	<b>1997 VENTURE MINI VAN</b> Stock #6285 Was \$22,169 Now <b>\$19,490</b> OR <b>\$299</b> Per Month

**Geo**  
**Chevrolet**

**HOURS**  
Mon., Thur. 9 a.m. - 9 p.m.  
Tues., Wed., Fri. 9 a.m. - 6 p.m.  
Sat. 9 a.m. - 4 p.m.

**CHAMPION**

5000 E. GRAND RIVER AT EXIT 141 1-96  
**517-545-8800 • 810-229-8800**

\*Price plus tax, title, license, & destination. All vehicles assigned to dealer. GM employees & family members save additional 5%. Subject to prior sale.  
\*All payments based on 36 mos. lease w/\$1000 cap cost reduction, 1st payment, refundable security deposit, tax, & plates due at lease ending. 12,000 miles per year w/15¢ per mile charge if over. Must add 6% use tax to all payments. Subject to credit approval.  
\*Payments are based on 20% down payment, plus tax, title and fees. 95% & 96% to finance for 60 mos. @ 10.25% APR. 94% to finance for 60 mos. @ 11% APR. 93% to finance for 60 mos. @ 11.25% APR. 92% to finance for 54 mos. @ 12% APR. 91% to finance for 48 mos. @ 12.5% APR. 90% & older to finance for 36 mos. @ 13% APR. Terms & rates may vary depending on lending institution. Subject to credit approval & all vehicles are subject to pre-sale.

# BRIGHTON FORD - MERCURY

LIVINGSTON COUNTY'S ONLY...

Our Goal "Customers For Life!!"

USED CAR and TRUCK FACTORY

# SUPERSTORE



**\$0 DOWN**  
NO PAYMENTS TIL SPRING

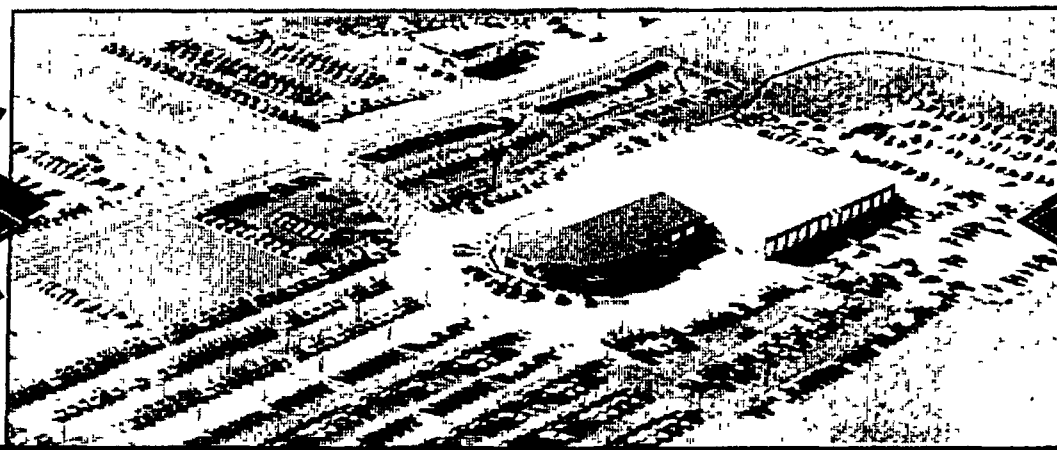

Hundreds of Vehicles On The Grounds



## MAIN LOT 1-800-603-3325

### AUTOS UNDER \$5,000

'87 TAURUS Cheap transportation.....	\$2,595
'91 TRACER Automatic, loaded.....	\$3,995
'94 FORD ASPIRE Great starter car.....	\$4,995
'89 TOYOTA CELICA Black on black.....	\$4,495

### AUTOS UNDER \$8,000

'95 ASPIRE Manager's special @.....	\$5,995
'92 TAURUS All the toys, a bargain at.....	\$6,995
'94 TEMPO Red & Ready.....	\$6,995
'92 GRAND AM 2 dr, automatic, loaded.....	\$6,995
'93 ESCORT GT Moonroof, low miles.....	\$6,995
'95 DODGE NEON 5 spd., great fuel-saver.....	\$7,995
'94 PROBE SE low miles, almost perfect.....	\$7,995
'95 ESCORT WAGON 3 to choose, starting @.....	\$7,995

### AUTOS UNDER \$10,000

'94 PROBES Many to choose, as low as.....	\$8,995
'95 CORSICA 4 dr., almost new, 22,000 miles.....	\$8,995
'93 GRAND MARQUIS Loaded, several to choose, starting at.....	\$9,995

### AUTOS UNDER \$12,000

'94 THUNDERBIRD Loaded, full power, choose, starting @.....	\$10,383
'92 LINCOLN CONTINENTAL Leather, low miles.....	\$10,480
'95 FORD MUSTANG A real eye catcher.....	\$10,995
'95 MERCURY MYSTIQUE Cream puff.....	\$11,777
'94 MERCURY COUGAR Loaded with leather.....	\$11,995
'95 FORD MUSTANG 5 speed, compare at.....	\$11,995
'95 GRAND PRIX 16,000 miles, loaded.....	\$11,995

### AUTOS UNDER \$20,000

'94 CROWN VICTORIA Loaded, leather.....	\$12,495
'95 FORD TAURUS LX Low miles, full power.....	\$13,988
'93 LINCOLN TOWN CAR Perfect luxury car.....	\$15,995
'96 FORD TAURUS GL Full power, 13,000 miles.....	\$16,888
'96 MERCURY SABLE All the toys.....	\$17,988

### TRUCKS VANS SPORT UTILITIES

#### UNDER \$10,000

'92 AEROSTAR 2 to choose, as low as.....	\$6,995
--	---------

'94 FORD RANGER XLT loaded.....	\$7,495
'95 RANGER SUPER CAB.....	\$9,995
'92 FORD F150 V8, low miles.....	\$9,995
'94 FORD F-150 XL 31,000 miles, only.....	\$9,995
'95 RANGERS 4 to choose from, auto, air, loaded, 3.0L motor, low, low miles, only.....	\$9,995

### TRUCKS VANS SPORT UTILITIES

#### UNDER \$12,000

'96 RANGER Splash package, 5 speed, air.....	\$10,995
'94 F150 XL 34,000 miles, one owner.....	\$11,995

### TRUCKS VANS SPORT UTILITIES

#### UNDER \$15,000

'95 FORD AEROSTAR Loaded, low miles.....	\$12,495
'94 VILLAGER Several to choose, as low as.....	\$12,995
'95 F150 XL 22,000 miles, one owner.....	\$12,995
'94 FORD F-150 SUPER CAB 8' bed.....	\$13,995
'94 F-150 S/C A/C, air, 8' bed, XLT, low, low miles.....	\$14,995

### THE REST OF THE BEST

'97 F-150 PICKUPS..... SAVE THOUSANDS OVER NEW	
'95 F150 S/C XLT 8 to choose from, auto, air, tilt, cruise, full power, was \$19,900, now only.....	\$17,685
'95 F150 SUPERCABS XLT'S 6 starting @.....	\$17,995
'95 EXPLORER XLT 4x4 Rare find, only.....	\$18,995
'96 CARGO VANS Many to choose, starting @.....	\$18,995
'95 BRONCO "EDDIE BAUER" Loaded.....	\$18,995
'95 EXPLORER XLT 2 DR Low miles, one owner.....	\$19,995
'94 F350 4x4 DUMP TRUCK 5 spd.....	\$19,995
'95 EXPLORER 4 door, low miles, loaded.....	\$21,250
'96 FORD F-150 8' bed, Eddie Bauer, clean and straight, low miles.....	\$21,495
'96 E-150 CONVERSION VANS Several to choose, all loaded with leather.....	\$22,495
'96 FORD F-150 S/CAB 4,000 miles, like new, XLT loaded, 6 passenger.....	\$22,995
'95 F-250 4x4 SUPER CAB Pure perfection, low, low miles, auto, air, XLT.....	\$22,995
'95 CLUB WAGON 7 passenger, loaded.....	SAVE!!!

## DISCOUNT LOT

NEW CREDIT ANALYST HOTLINE 1-800-866-3712

**The Cheapest Used Cars & Trucks in Livingston County! Discount Does It Better!**

'82 FORD T-BIRD Runs good.....	\$1,195
'83 LINCOLN MARK 6 Loaded.....	\$1,195
'85 DODGE D-180 P/U Wood hauler.....	\$1,295
'87 FORD ESCORT LX Runs good.....	\$1,295
'85 OLDS CUTLASS V6, auto., air.....	\$1,295
'87 FORD TAURUS ST-WAGON Runs great.....	\$1,995
'87 FORD MUSTANG LX One owner.....	\$1,995
'84 PONTIAC FIREBIRD One owner.....	\$3,495
'88 PONTIAC GRAND AM Runs great, wow!.....	\$3,895
'92 MERC TOPAZ 2 DR. Air, low miles.....	\$4,950
'89 CHEVY BERRETTA Wow.....	\$4,995
'93 FORD ESCORT LX Air, auto., stereo.....	\$5,850
'91 FORD F-180 XLT Auto., loaded.....	\$6,995
'93 FORD PROBE'S 3 to choose, starting at.....	\$7,495
'93 FORD RANGER XLT SUPER CAB Air, low miles.....	\$7,700
'93 OLDS CIERA V6, loaded, like new.....	\$7,800
'93 PONTIAC GRAND AM S/E V6, air, auto.....	\$7,900
'93 CHEVY S-10 P/U Auto., Stereo, V6.....	\$7,950
'90 NISSAN P/U EXTEND CAB Low miles.....	\$7,995
'92 PONTIAC BONNEVILLE Loaded.....	\$7,995
'93 FORD XL P/U 6 cyl., auto., air.....	\$9,650
'93 FORD AEROSTAR XL 6 cyl.....	\$9,950
'94 GMC SONOMA P/U Wow.....	\$9,900
'94 FORD AEROSTAR SPORT Loaded.....	\$9,980
'93 FORD E-250 CARGO VAN Air, auto.....	\$10,950
'94 FORD MUSTANG GT V8, air, auto.....	\$12,400

### PUBLIC NOTICE

Our Huge New Car And Truck Sales Volume Insures A Constant Supply Of LOW MILEAGE - One Owner Trade-Ins. FRESH ARRIVALS DAILY!

NEED HELP WITH CREDIT PROBLEMS? WE ARE THE EXPERTS We'll treat you right and get you behind the wheel

**CREDIT HOTLINE 1-800-707-3673**

## THE BIG 3 ON GRAND RIVER

<b>MAIN LOT</b> 8240 W. GRAND RIVER BRIGHTON 227-1171	<b>NEW CAR SHOW ROOM</b> 8240 W. GRAND RIVER BRIGHTON 227-1171	<b>DISCOUNT LOT</b> 8797 E. GRAND RIVER BRIGHTON 227-7253 1-800-707-3673
--	---	--

### EASY FREEWAY ACCESS FROM ALL AREAS!

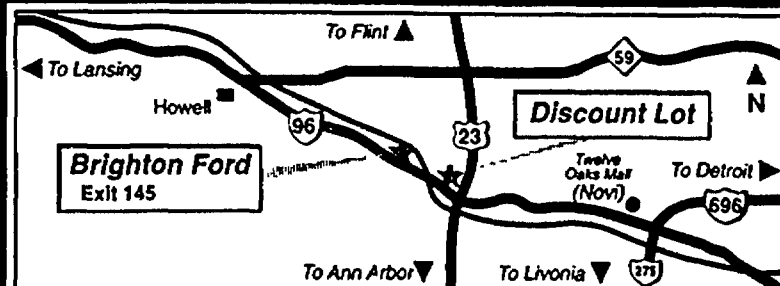

Easy Freeway Access From All Areas

\*With approved credit. See dealer for details.

700 Absolutely Free

GOLDEN RETRIEVER, female 8 yrs., exc. pet. Must go due to allergies (810)486-7000

Trail on Dolls, Bears, etc. Sale ends Feb. 6th. (810)486-0450

Feb. 2, Mat hours. China & pottery repair.

WANTED: ANTIQUES, collectibles, old things. Call Mary (810)229-4485.

WANTED: QUALITY antique oak furniture or any other old item. Cash paid for 1 piece or an entire estate. (517)548-7104

FLINT ANTIQUE Bottle Collectible Club show on sale. Sun, March 23, 1997, 9am-3pm at Dorc Pitski Hall, 3415 N Linden Rd., Flint, MI. For information & the bottle appraisal contact Richard Franks (810)735-7381

702 Antiques/Collectibles

ALL ANTIQUES BOUGHT Postcards, china, cups/saucers, CHINA, CHINA miniatures, perfume bottles, toys military (810)624-3385

704 Arts & Crafts

HAFNER ANTIQUES in Stockbridge now has booth space for rent to quality antique & craft dealers (517)851-7813

706 Auction Sales

AUCTION - SUNDAY Jan. 26, 11am-5pm Wed., Thurs. 9a. prior to sale LAKE ORION AUCTION GALLERY 711 W. Clarkston Rd Lake Orion (1 mile W of M-24)

Rainbow Promotions Presents "CABIN FEVER" Art & Craft Show January 25 10 am-4 pm BRIGHTON HIGH SCHOOL (Main St & Seventh St) Don't Miss It! Admission \$2 Under 12 Free

707 Estate Sales

ACQUING & SELLING QUALITY FURNITURE DECORATIVE ACCESSORIES AND ANTIQUES One Item or a House Full Consign in Our Showroom

Arrow Auction Service Auction is our full time business Households - Farm Estates Business - Liquidations Roger Andersen (810) 227-6000

SEATTLE AUCTION 4320 Madison St. Howel, Ia. Furniture, riding mower, etc. Sale held outside Estate of Dr. & Mrs. Charles Hill. Auctioneer Ray Egnash (517)546-7496 (517)546-2005

GREEN SHEET ACTION ADS GET RESULTS

BRIGHTON CHRYSLER SAVE! SAVE! SAVE! SAVE! '96 DODGE STRATUS 4 to choose! Under 12,000 miles with auto., air, power windows, tilt & cruise. Were \$17,995 NOW \$13,995

BRIGHTON CHRYSLER PLYMOUTH-DODGE-JEEP-EAGLE 9827 E. GRAND RIVER, BRIGHTON 810-229-4100

Switch to LaRiche Great Selection Great Price - Great Service 3.9% APR EXTENDED THRU JAN. 31st Lou LaRiche CHEVROLET. GEO

BRAUN & HELMER AUCTION SERVICE Farm, Household, Antique, Real Estate, Miscellaneous Lloyd R. Braun (313) 665-9646 Jerry L. Helmer (313) 994-6309

LIVING ESTATE AUCTION Sat Jan 25th 11am 320 Madison St. Howel, Ia. Furniture, riding mower, etc. Sale held outside Estate of Dr. & Mrs. Charles Hill

BRIGHTON CHRYSLER PLYMOUTH-DODGE-JEEP-EAGLE 9827 E. GRAND RIVER, BRIGHTON 810-229-4100

Varsity Ford Not Hundreds of Cars & Trucks in Stock, But THOUSANDS of Cars & Trucks in Stock - Just Like Shopping at the Factory!

AUTO SHOW STOPPERS! WE'VE GOT THE DEALS TO PUT YOU ON WHEELS 1.9% APR FINANCING AVAILABLE \$3400+ UP TO \$8000 FACTORY REBATES DISCOUNTS

'97 ESCORT "TOURING" PKG. LX 4 DR. \$179 DOWN \$179 PER MONTH '97 CONTOUR "TOURING PKG." 4 DR. SEDAN \$229 DOWN \$229 PER MONTH '97 EXPLORER 4X4 XLT 4 DR. \$379 DOWN \$379 PER MONTH '97 RANGER XLT PICKUP \$149 DOWN \$149 PER MONTH '97 F150 "SUPERCAB" PICKUP \$229 DOWN \$229 PER MONTH

'97 ASPIRE "3 DOOR" \$8990 '96 TAURUS SHO \$22,590 '96 THUNDERBIRD "LX" 2 DR. \$14,890 '97 TAURUS "4 DR." SEDAN \$15,390 '97 TAURUS "LX" 4 DR. SEDAN \$13,490 '96 CONTOUR "GL 4 DR. SEDAN \$13,490

'97 TAURUS "GL" SPORT PKG. 4 DR. \$16,990 '96 E150 "UNIVERSAL" CONVERSION VAN \$269 DOWN \$269 PER MONTH

'96 WINDSTAR GL MINIVAN \$17,690 '96 F150 EDDIE BAUER PICKUP \$16,290 '96 E250 SUPER CARGO VAN \$16,990 '97 F350 "4X4" 4 DR. PICKUP \$29,990 '97 F250 4X4 PICKUP \$19,690

3480 JACKSON AT WAGNER, ANN ARBOR, MI I-94 EXIT #172, TURN LEFT 313-996-2300 ANN ARBOR

Varsity Ford logo and contact information for the conversion van section.

FULL TANK OF GAS WITH EVERY PURCHASE MICHIGAN'S MOST COMPREHENSIVE TRUCK INVENTORY, INCLUDING: 4X4'S CREW CABS, DUALY, STAKE, DUMP TRUCKS, POWER STROKE DIESELS, V-10'S, HANDICAP VANS, PARCEL DELIVERIES, EXPLORERS.

MICHIGAN'S "A" PLAN HEADQUARTERS CALL TOLL FREE 1-800-875-FORD









**THE WORLD'S #1 LINCOLN MERCURY DEALER  
COMES TO HOWELL!**

**OPEN  
SATURDAY!**

**OPEN  
SATURDAY!**

# KRUG'S

**HILLTOP**



**FORD LINCOLN MERCURY**

**FORD  
MERCURY**

**Expect nothing but the best!**

**Your A-Z-B-X  
Plan Specialists!**

**INVENTORY:  
WE HAVE IT!  
OVER  
450 CARS & TRUCKS**

**We Have Them All  
F-150-250-350, 4x2, 4x4  
Diesel, 15 F-250 Diesels**

**96 BLOWOUT**

<b>1996 EDDIE BAUER EXPLORER 4X4</b> 942A pkg., trailer tow, console, CD, moon, list \$33,245, You pay \$7,750 <b>SAVE \$ 5495</b>	<b>1996 WINDSTAR GL</b> 7 passenger, 470A pkg., rear defrost, mats, speed and tilt, list \$21,471, you pay \$5850 <b>SAVE \$ 5621</b>	<b>1996 WINDSTAR GL</b> Quadseats, 472A pkg., alum. wheels, mats, pri- vacy glass, slide drivers seat, list \$24,405, you pay \$18,274 <b>SAVE \$ 6131</b>
<b>1996 WINDSTAR GL</b> 7 passenger, seat, bed, console, dual air, luggage rack, privacy glass, list \$24,220, you pay \$18,072 <b>SAVE \$ 6148</b>	<b>1996 MUSTANG COUPE</b> pkg. 243A, 3.8L, auto. trans., mats, rear defrost, list \$18,740, you pay \$15,400 <b>SAVE \$ 3340</b>	<b>1996 MUSTANG GT CONVERTIBLE</b> Laser red, pkg. 249A, auto. trans., CD, mach 460 ste- reo, 17" wheels, keyless anti-theft, rear defrost, list \$28,240, you pay \$23,500 <b>SAVE \$ 4740</b>
<b>1996 F350 CREW CAB</b> bright red, pkg. 671A, 7.3 power, stroke, auto., 4:10 axle, dual rear wheels, premium centurion conv. pkg., list \$38,450, you pay \$32,450 <b>SAVE \$ 6000</b>	<b>1996 E150 JAYCO CONVERSION VAN</b> 5.0L, AM/FM cass., rear bed, running boards, dual air & heat, super sharp, sharp, list \$27,921, you pay \$22,000 <b>SAVE \$ 5921</b> CHOOSE FROM TWO	<b>CHECK THIS NEW 1995 SABLE LS</b> loaded, midnight green, leather <b>YOU PAY SAVE \$ 15,555</b>

## PREMIUM USED VEHICLES

<b>'95 FORD-150 4X4 XLT,</b> auto., air, 302.....	<b>\$16,888</b>
<b>'95 EXPLORER SPORT,</b> one owner, auto., 4x4, full power.....	<b>\$18,888</b>
<b>'93 VILLAGER GS,</b> 35,000 miles, very clean, full power.....	<b>\$10,888</b>
<b>'95 FORD CONVERSION VAN,</b> 10,000 miles, one owner.....	<b>\$17,888</b>
<b>'96 WINDSTAR LX,</b> full power, 7 passenger, tu-tone, only.....	<b>\$16,888</b>
<b>'94 PROBE SE,</b> auto, air, full power, very clean, low miles.....	<b>\$9988</b>
<b>'95 MUSTANG GT,</b> 24,000 easy miles, auto., air.....	<b>\$13,888</b>
<b>'95 SABLE GS STATION WAGON,</b> 13,000 miles, one owner, like new.....	<b>\$14,888</b>
<b>'92 GRAND MARQUIS,</b> full power, a great buy at.....	<b>\$9988</b>
<b>'90 LINCOLN TOWN CAR SIGNATURE SERIES,</b> half top, 58,000 miles, a must see.....	<b>\$12,888</b>
<b>'94 FORD F-350 CREW CAB DUALY,</b> 29,000 miles, 460, V8, auto.....	<b>\$19,688</b>
<b>'94 T-BIRD,</b> V6, auto., air, full power, 44,000 miles.....	<b>\$9988</b>
<b>'94 GRAND MARQUIS LS,</b> 24,000 miles, every power option, fast warranty.....	<b>\$14,888</b>
<b>'94 DODGE CARAVAN,</b> auto., air, 58,000 miles, drives great.....	<b>\$8988</b>
<b>'95 MUSTANG HATCHBACK,</b> auto., air, stereo.....	<b>\$9988</b>
<b>'94 LINCOLN CONTINENTAL,</b> leather, 35,000 mi., Factory warranty, very clean.....	<b>\$15,988</b>
<b>'94 LINCOLN MARK VIII,</b> 29,000 miles, factory warranty, mint condition.....	<b>\$17,988</b>
<b>'94 COUGAR XR7,</b> 21,000 miles, loaded, factory warranty.....	<b>\$10,988</b>
<b>'93 GRAND MARQUIS,</b> 41,000 miles, all power, a steal at only.....	<b>\$11,688</b>

**HOURS: Showroom**  
8 am-9 pm Mon. & Thurs.  
8 am-6 pm Tue., Wed., Fri.  
9 am-3 pm Sat.

**Parts, Service, Body Shop**  
8 am-9 pm Mon. & Thurs.  
8 am-6 pm Tues., Wed., Fri.

**HOWELL**  
(517) 546-2250

# KRUG'S

**HILLTOP**

**FORD LINCOLN MERCURY**  
2798 E. Grand River, Howell, MI  
**1-800-258-5603**

**JUST 2 MILES  
EAST OF HOWELL  
ON GRAND RIVER**

\*All vehicles subject to prior sale.  
All prices plus tax, title, license.

\*\*All vehicles subject to prior sale.  
Prices plus tax, license.

**DETROIT**  
(313) 963-8959

018-GREENSHEET EASTORENTIVE LIVING - Thursday, January 23, 1997

# WALDECKER IN FOWLerville

## INVENTORY REDUCTION SALE NOW

3.9% APR 1996-1997 Chevy Lumina Cavalier 60 Mos.	\$1000 Rebate 1996-97 Chevy S-10	1996 CHEVY LUMINA LS Keyless entry, cruise, aluminum wheels DEMO #6153	Only <b>\$16,995*</b> Was \$20,255
Oldsmobile Aurora '97 Save \$2000	\$1500 Off 1997 Trackers or \$2000 on 1996 Trackers	1996 CHEVY BLAZER 4 DR. 4X4 LT #6492 Leather, Loaded	Only <b>\$24,995*</b> Was \$29,673
3.9% APR 60 Mos. Chevy Astro Vans		1996 OLDS CUTLASS SUPREME SK #6067 Save Over \$2,600	Only <b>\$16,995*</b>

\* All financing based on approved credit. Specials & rebates for week ending 1-27-97. Prices plus tax, title, plates.

### INTRODUCING OUR: CREDIT RESOURCE CENTER

**BANKRUPTCIES**    **CHARGE-OFFS**    **DIVORCE**  
**REPOSESSIONS**    **NO CREDIT**    **MEDICAL BILLS**

24-HOUR PRE-APPROVAL HOTLINE  
**1-800-281-6993**  
 NEW & USED VEHICLES

# WALDECKER IN BRIGHTON

## Announcing The LeSabre Lease of the Season!

Only **\$299** plus tax  
 per month 48 months.

1997 BUICK LESABRE CUSTOM

**64 In-Stock!**

**WALDECKER COUPON**  
**1997 PONTIAC GRAND AM SPECIAL**  
**FREE**  
 complimentary Pop-Up Sunroof  
 with Grand AM Purchase\*

\*Prior purchases excluded. In stock vehicles only. Offer Expires 1/31/97

**\$2500** Rebate On 1996 Buick Regals. Great Selection Available

**3.9% APR** 48 Months on **SUNFIRES & GRAND AMS**

# WALDECKER



Geo

**New Location!**  
 Chevrolet - Oldsmobile - Geo  
**880 S. Grand, Fowlerville (Near I-96)**  
**(517) 223-9142**  
 Hours: Mon. & Thurs. 8:30-9;  
 Tues., Wed. & Fri. 8:30-6; Sat 10-4

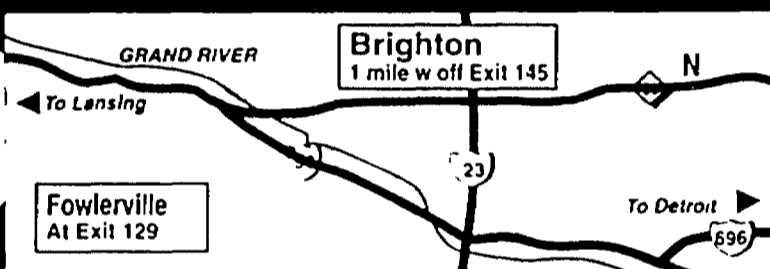

**Pontiac-Buick**  
**7885 Grand River, Brighton**  
**(810) 227-1761**  
 Hours: Mon. & Thurs. 8:30-9;  
 Tues., Wed. & Fri. 8:30-6; Sat 9-4



\*Prices and special offers good thru Tues., Jan. 27, 1997. Subject to pre-sale. All prices, plus taxes, title and plates. After rebate. Pictures do not necessarily represent vehicles.

## YOUR "GM CONNECTION" in LIVINGSTON COUNTY

### FOWLerville'S FINEST PREVIOUSLY OWNED VEHICLES

'96 OLDS DELTA 88 LS Loaded, leather, low miles	Lease For <b>\$269**</b>	'92 OLDS CIERA 4 DR. P4698, auto, air, p.w., pl., cruise tilt	<b>\$5,995*</b>
'96 PONTIAC GRAND AM SE 6 cyl., 4 dr. cassette	Lease For <b>\$221**</b>	'91 OLDS SUPREME CONVERTIBLE 4514B White & ready gray leather	<b>\$11,995*</b>
'96 OLDS SUPREME 4 DR. 7268A V-6 4 dr., got all the toys	Lease For <b>\$187**</b>	'91 PONTIAC SUNBIRD LE 2 DR. 4 cyl. auto AC	<b>\$3,995*</b>
'95 BUICK CENTURY V6 cassette, clean	Lease For <b>\$154**</b>	'90 CHEVY CAVALIER RS 4 DR. Loaded	<b>\$3,995*</b>
'95 CHEVY BERETTA 65138, 6 cyl., purple passion	<b>\$8,595*</b>	'89 PONTIAC GRAND AM 2 DR. P4737 4 cyl. auto, air	<b>\$4,995*</b>
'95 CHEVY CORSICA P4708 4 cyl., low payments	<b>\$8,995*</b>	<b>TRUCKS &amp; VANS</b>	
'95 GEO METRO 3 DR. P4702, great MPG, commuter special	Lease For <b>\$144**</b>	'96 CHEVY 1/2 TON PICKUP 5.7L Silverado Ext Cab, low miles	Lease For <b>\$226**</b>
'95 CHEVROLET MONTE CARLO LS All the toys	Lease For <b>\$179**</b>	'96 CHEVROLET SUBURBAN 1/2 TON 4x4, loaded, leather	<b>\$28,995*</b>
'95 CHEVY MONTE CARLO Z34 Nothing but power!!	<b>\$14,495*</b>	'95 CHEVY APV P4675, 8 pass., power slider CO	Lease For <b>\$241**</b>
'95 DODGE INTREPID ES Loaded, V-6	<b>\$12,595*</b>	'94 CHEVY P/U 4X4 1500 Z-71 Cap, loaded	<b>\$16,995*</b>
'94 OLDS CUTLASS SUPREME All the bells & whistles	<b>\$10,995*</b>	'94 CHEVY 1/2 WT 7287A, V-8 auto, air	<b>\$8,795*</b>
'94 PONTIAC BONNEVILLE SSE Loaded, leather	<b>\$15,395*</b>	'94 CHEVY ASTRO P2266, 4.3V-6, conversion	<b>\$11,995*</b>
'93 PONTIAC GRAND PRIX SE 2 door, loaded	<b>\$9,995*</b>	'94 GMC JIMMY P4674, SLT 4x4, leather, loaded	<b>\$17,395*</b>
'93 OLDS SUPREME P4662, 3100 V-6, p.w., pl., cruise, tilt	<b>\$9,995*</b>	'92 CHEVY LUMINA APV 7325A, 6 cyl., p.w., pl., cruise	<b>\$8,595*</b>
'92 PONTIAC SUNBIRD GT 2 DR. Loaded, low miles	<b>\$9,995*</b>	'90 OLDS SILHOUETTE 8531A, V-6, p/seats, leather, loaded	<b>\$7,995*</b>
'92 OLDS DELTA 88 Miles and color are perfect!	<b>\$7,995*</b>	<small>**36 month closed end non-maintenance lease to qualified customer. Add 6% use tax for total monthly payment. 96's returned with not more than 55,000 miles, 95's with 65,000 miles 15 cents per excess mile. Lessee has option to purchase at lease end for price determined at lease inception, lessee not obligated to purchase at lease end. Lessee responsible for wear and tear. Refundable security deposit, first payment, 10% down payment, use tax, title and license fee due at inception. Payments x 36 equal total payments</small>	

\*All prices plus taxes, title, plates

### BRIGHTON PREVIOUSLY OWNED VEHICLES

'96 PONTIAC GRAND AM 2 door, 4 door	from <b>\$13,495*</b>	'93 PONTIAC GRAND PRIX SE 2 dr., white 6 cylinder	<b>\$9,750*</b>
'96 OLDS 88 ROYALE 13,500 Miles	<b>WON'T LAST</b>	'93 CHEVY CAVALIER WAGON Auto air, deep tint sharp	<b>\$7,995*</b>
'96 PONTIAC BONNEVILLE SE Green, leather, cloth	<b>Only</b>	'93 BONNEVILLE SSEI Super charges, moon roof, white	<b>WON'T LAST</b>
'95 CHEVY CORSICA White auto air, PW PI	<b>\$8,995*</b>	'92 OLDS 88 6 cylinder auto air, power windows and more	<b>\$7,975*</b>
'95 PONTIAC GRAND AM GT COUPE V-6 alum wheel's spoiler	<b>\$13,450*</b>	'92 PONTIAC SUNBIRD GT COUPE V-6, only 19,950 miles.	<b>SHARP!</b>
'95 PONTIAC SUNFIRE, 4 DR. Auto air, AM, FM, red	<b>\$11,495*</b>	'90 BUICK CENTURY V6 White	<b>4,500 Miles</b>
'95 BUICK RIVIERA Super charged 3800 leather CD Has it all. won't last!	<b>\$21,995*</b>	'91 TOYOTA COROLLA 5 spd., air, gas meter	<b>\$3,950*</b>
'95 DODGE INTREPID ES V-6, full power	<b>\$12,900*</b>	'91 CHEVY CAPRICE CLASSIC White, many extras	<b>43,400 Miles</b>
'95 BUICK CENTURY Maroon V-6, many extras	<b>\$11,900*</b>	'85 BUICK CENTURY WAGON 6 cyl., auto, air, third seat	<b>\$3,275*</b>
'95 PONTIAC GRAND AM 4 door, aqua	<b>\$10,995*</b>	<b>TRUCKS</b>	
'95 CHEVY CORSICA V-6 auto air, 4 door	<b>\$8,995*</b>	'96 GMC JIMMY SLT Leather, many extras	<b>\$23,995*</b>
'95 CHEVY MONTE CARLO Z-34 Auto air, cassette, Black beauty!	<b>\$14,900*</b>	'96 BLAZER LT 4 DR. 4X4 Teal & Clean.	<b>\$23,995*</b>
'94 GRAND AM GT COUPE Low miles	<b>\$10,495*</b>	'95 GMC JIMMY SLT Only 23,100 miles	<b>WON'T LAST</b>
'94 PONTIAC BONNEVILLE SSE Green Italian leather, sharp	<b>\$15,900*</b>	'96 PONTIAC TRANS SPORT SE 6 cylinder, full power	<b>WON'T LAST</b>
'94 OLDS CIERA WAGON Thud seat, V-6	<b>\$10,900*</b>	'95 BLAZER LS Blue/silver, full power	<b>\$19,900*</b>
'94 BUICK LESABRE Full power, V6, low miles, more...	<b>\$14,450*</b>	'95 OLDS SILHOUETTE V-6, power seat, many extras	<b>\$16,650*</b>
'94 PONTIAC BONNEVILLE SSE White, loaded...	<b>26,900 Miles</b>	'95 CHEVY 1500 LONG BOX 4x4 Only 24,000 miles	<b>\$16,995*</b>
'94 BUICK LESABRE Full power, 6 cylinder, white	<b>\$14,750*</b>	'96 CHEVY 1500 EXTENDED CAB 4X4 Silverado package, maroon	<b>SAVE</b>
'93 PONTIAC BONNEVILLE SE Black	<b>\$11,921*</b>	'94 OLDS SILHOUETTE Medium blue, low low miles, won't last at	<b>\$14,995*</b>
<b>Visit us at <a href="http://www.getauto/waldecker.com">http://www.getauto/waldecker.com</a></b>		'93 OLDS BRAVADA Loaded	<b>\$15,750*</b>
		'92 FORD EXPLORER 4X4 4 Dr	<b>\$10,995*</b>

\*All prices plus taxes, title, plates

# PRICE

# SLICER

Bargains from  
local merchants  
inside!

HomeTown  
**Extra**  
Newspapers

A supplement to  
The South Lyon Herald • Milford Times • Northville Record • Novi News



# INVENTORY CLEARANCE EVERYTHING ON SALE!

Large Selection of  
**DIAMOND  
JEWELRY**  
50-64% OFF

Bangle Bracelets  
Anniversary Rings  
Diamond Slides

Large Selection of  
**GEMSTONE  
JEWELRY**  
50% OFF

Ruby Bracelets  
Pearl Earrings  
& Rings

Selected Swiss  
**WATCHES**  
50% OFF

Movado, Zodiac,  
Bulova,  
Caravelle,  
ESQ

**14 KT  
GOLD**  
50% OFF

Mens Bracelets  
Gold Earrings  
Charms

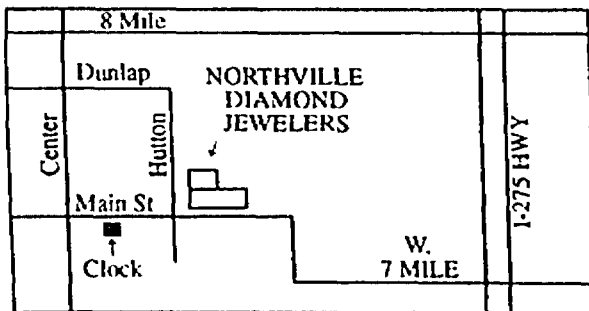

**SALE HOURS:**

Mon.-Fri. 10-6:00  
Saturday 10-5:00  
*or by appointment*

**FINAL THREE DAYS**  
**Thursday, Friday, Saturday**  
**January 23, 24, 25**



**Northville Diamond Jewelers**

*Designers*      *Manufacturers*

201 E. Main St. on Hutton, Downtown Northville (810)348-6417





Your Mother always  
told you to **STOP**  
running around.

Turns out she had it all wrong.

Sorry Mom, the U.S. Surgeon General just released a landmark report that basically states the more you exercise the longer you'll live and the happier you'll be.

Not so coincidentally, we want to remind you of how beneficial a fitness membership with us can be. You'll feel like a kid again, and finally get the chance to run around all you want.

- A welcoming, comfortable environment for people of all fitness levels.
- Convenient downtown location with plenty of parking.
- Customized, one to one toning, shaping and strength programs.
- Full line of the latest cardiovascular, strength and circuit equipment.
- Individual nutritional and weight management programs.
- Stress reduction, including massage therapy and relaxation programs.
- Child sitting and active wear shop.
- Unique café and refreshments.
- First class locker and shower area.

Start looking and feeling better today.  
Stop by or call (810) 449-7634 for additional information.

*We're looking forward to meeting you.*

**Come In For Your  
FREE VISIT\***

**FREE Trial Membership  
Card. Stop in today and  
see how easy it is to get  
your program started.**

**HOURS:**

Mon.-Fri. 5:30 a.m.-9:30 p.m.

Sat. 8:00 a.m.-6:00 p.m.

Sun. 9:00 a.m.-6:00 p.m.

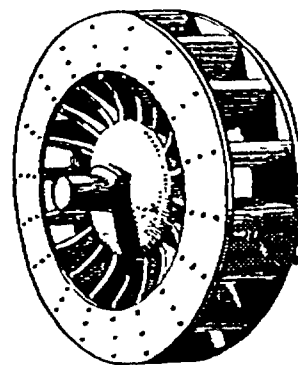
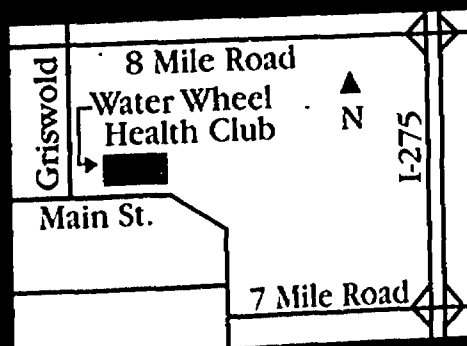

**Water Wheel**

HEALTH CLUB  
INC.

235 East Main / Northville, MI 48167

**(810) 449-7634**

*\*Must be a Michigan resident, 18 years or older.*



E  
L  
A  
S

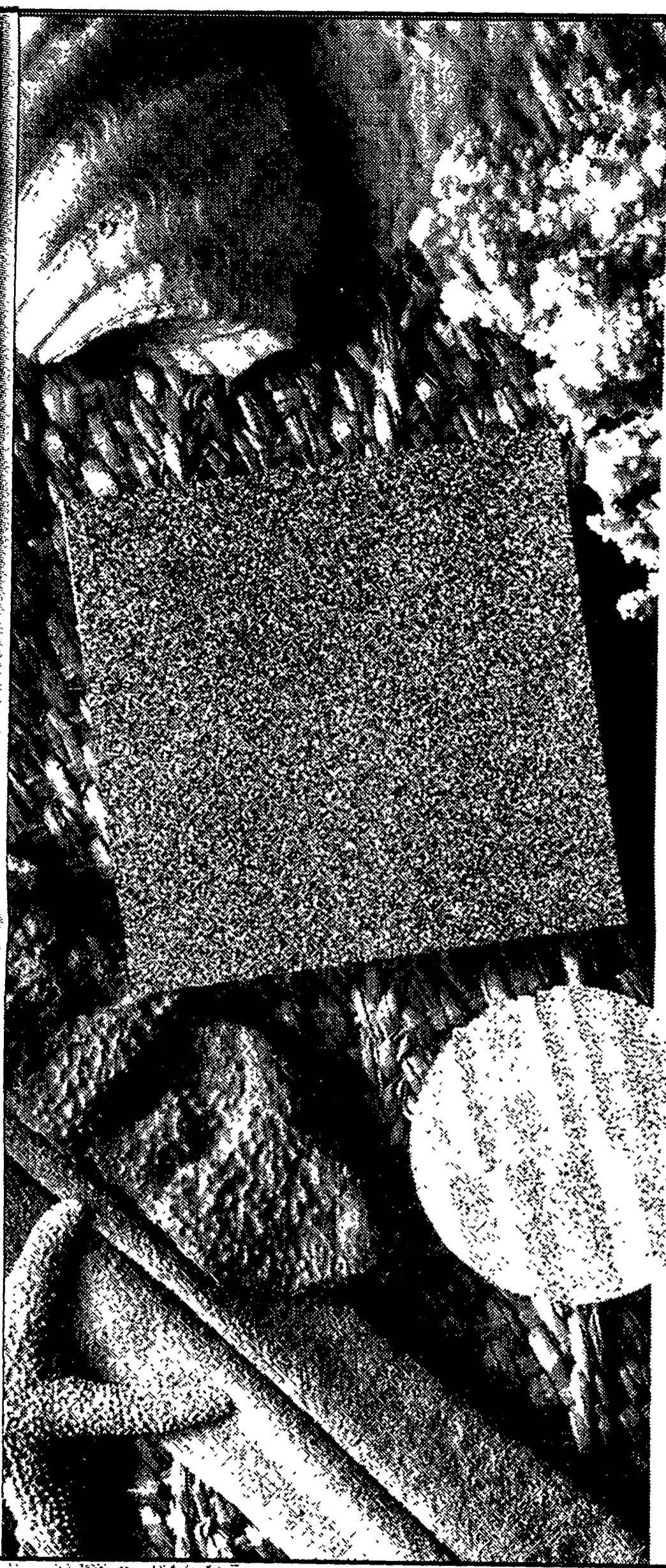

# VIOS™

A R M S T R O N G

*Come, sculpt  
a floor with  
us. VIOS™. The  
possibilities  
are endless.*

SALE starts January 24 - February 15  
10% OFF SR. CITIZEN DISCOUNT

## Novi Carpets

Monday 9-8  
Tuesday - Saturday 9-5:30

41300 West 10 Mile • Novi  
East of Meadowbrook



(810)477-0640

# CABLE RATES ARE GOING THROUGH THE ROOF!



## DISH NETWORK. . . YOUR TRUE CABLE ALTERNATIVE.

There just doesn't seem to be any end to rising cable rates. So maybe you should think about DISH Network, where you get a lot more programming for a lot less money.

Imagine receiving 50 of America's most popular TV channels, including The Disney Channel. Then add over 30 CD-quality stereo all-music channels.

That's what you get with DISH Network's America's Top 50 CD™ programming package for only \$300 for an entire year (that works out to only \$25 a month)! It's hard to imagine what cable would charge you for all this – if they even offered all the same outstanding programming.

And all it takes to receive all this great programming is our state-of-the-art IR satellite TV system that you can own for just \$199. So if you're tired of cable rates going through the roof, subscribe to DISH Network today.



- The Disney Channel • ESPN • ESPN2 • ESPNEWS • E! • TNT • Nick at Nite's TV Land • Comedy Central • Nickelodeon • Nick at Nite • TBS • MTV
- The Family Channel • A&E • Court TV • CNN • CNN Financial News • CNN International • Headline News • KTLA • C-SPAN • C-SPAN2 • Discovery Channel • Animal Planet • WSBK • USA Network • The Learning Channel • CNBC • The Sci-Fi Channel • Black Entertainment Television • QVC
- Country Music Television • Game Show Network • Lifetime • National Empowerment Television • Turner Classic Movies • VH1 • WGN • Home Shopping Network • WPIX • EWTN • The Cartoon Network • The History Channel • The Weather Channel • Home & Garden TV • TV Food Network
- The Travel Channel • The Nashville Network • TBN • DISH CD • Plus a Regional Sports Network •



## DigiComm Electronics, Inc.

22882 Pontiac Trail • South Lyon, MI 48178

**(810) 486-4343**



Nothing Else Compares.™

All prices, packages and programming subject to change without notice. Local and state sales taxes may apply. Programming is available for single-family dwellings located in the continental United States. All DISH Network programming, and any other services that we provide, are subject to the terms and conditions of the Residential Customer Agreement, which is available upon request. One-year America's Top 50 CD package in nonrefundable, and subject to early termination if additional services ordered are not paid in accordance with agreed-upon terms. Broadcast Networks are only available to customers in those areas not served by local network affiliates. Prices do not include installation or shipping and handling. All receivers must be connected to a phone line. Must activate programming by February 28, 1997. DISH Network is a trademark of EchoStar Communications Corporation. ESPN and ESPN2 programming subject to change and blackout restrictions, and is licensed separately for residential and commercial use. ESPN, ESPN2 and ESPNEWS are registered trademarks of ESPN, Inc. ©Disney, MTV: Music Television, VH1 Music First, Nickelodeon/Nick at Nite and Nick at Nite's TV Land are trademarks of MTV Networks, a division of Viacom International Inc. Cartoon Network, CNN, CNNI, CNN FN, Headline News, TCM, TBS Superstation and TNT are registered trademarks of Turner Broadcasting Systems, Inc. The Family Channel and The Family channel logo design are registered service marks of International Family Entertainment, Inc. Home Shopping Network is a registered trademark of Home Shopping Network, Inc. FOX Sports Networks programming subject to blackout restrictions and licensed for residential use only. Regional sports networks not available in all areas. All other service marks and trademarks belong to their respective owners. 12/26/96

Huntington Sq.

# CLEANERS

(810) 486-4700

644 N. Lafayette • South Lyon • In Huntington Square  
**HOURS:** Mon.-Fri. 8:30-7:00; Sat. 9:00-5:00

- Expert Dry Cleaning • Shirt Laundry
- Alterations & Repairs • Leather Cleaning & Repair • Wedding Dress Preservation

# 25% OFF

Incoming Dry Cleaning Only

expires 2-8-97

Huntington Sq.

# CLEANERS



# B.K.S. Collision, Inc.

56891 Grand River  
 corner of Grand River & Milford Rd. • New Hudson

(810) 437-9131 (810) 437-9625

Hours: Mon. - Thurs. 8-6; Fri. 8-5; Sat. by appt. 9-12

**Your full service auto body repair shop**

- Free Estimates • Complete Bumping & Painting
- All Insurance Work • Car Rental Available

# \$50.00 Off

## Insurance Deductible

on any job over \$350 in labor not to be combined with any other offer • coupon must be presented at time of estimate or not valid • expires 2-23-97

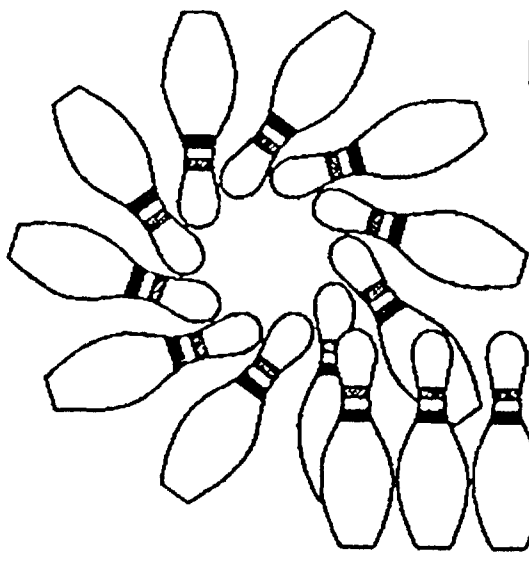
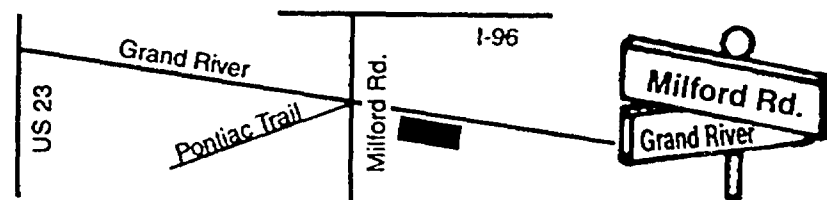

# 700 BOWL

700 N. Lafayette • South Lyon (810) 437-0700

**Friday Nights**

6:00-10:00pm

2 hours bowling  
 one large pizza only

# \$20.00

per lane, shoe rental extra

**Superbowl XXXI**

**Tailgate Party**

January 26, 1997

Reserve your seats now!

only **\$10.00** per person

includes: 2 complimentary drinks, munchies, half-time buffet, happy 1/2 time

Door Prizes • Shot Specials

Starts at 5:30pm in Sandbagger's Sports Lounge

Introducing 700 Bowl's NEW

**Adult/Youth**

**Breakfast & Bowl League**

Pancakes, Bacon or Sausage, Juice or Coffee

Short 12 Week Season

Begins January 26, 1997

Only \$8.00 per person/week

\$5.00 per person registration fee required

Breakfast at 9:30 am

Bowl at 10:30 am

FREE 13th week banquet

Free Secretarial Service

Youth Trophies

Somethin' NEW is cooking at 700 Bowl!

**Monday Night Mens Trio League**

**\$500.00 First Place** based on 10 teams

Short 12 Week Season

Begins January 27, 1997 - 9:00 pm

includes: First Place Trophies

Pizza Banquet - 13th week

Secretary/Treasurer Service

If your New Year's Resolution is to lose weight the **HEALTHY** way, then pick up some **GREAT-TASTING, LOW FAT** Italian meals from

We Provide:  
— High Energy,  
Low-Fat Meals

**810-380-3232**

**Santino's**  
*for pasta*  
**Place**  
Italian Carry-Out & Catering

— Great Italian Favorites  
Prepared Healthy & Tasty  
— Low Prices  
— Big Portions

"You've tried the rest **NOW** prepare yourself and your family for **THE BEST!!!** I promise if you don't enjoy your meal, I'll **REFUND YOUR MONEY\***

\*Within 24 hours of ordering

Scott Longas, Owner

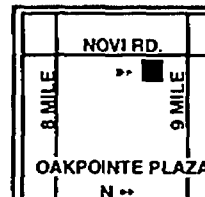

**22200 Novi Road**  
(In the Oakpointe Plaza Between 8 & 9 Mile)  
**NOW OPEN 7 DAYS!**

Hours: Mon.-Sat. 11am-9pm; Sunday 12pm-9pm  
Visa • Mastercard

**Family Value Meals**  
*Feeds 4 • With Salad & Garlic Bread*

Meat or Cheese Ravioli.....	15.99
Meat or Cheese Tortellini.....	15.99
Family Santino "Explosion".....	16.99
(3.6 grams of fat per serving)	
Pasta Delight.....	16.99
<i>Not valid with any other offers</i>	

**Create Your Own Pasta Dish**  
*Choose Your Choice of Noodle & Sauce*

Noodle	Sauce
Angle Hair	Turkey Meat
Linguine	Marinara
Fettuccine	Veggie Meat
Mostoccioli	Fat-Free Tomato & Basil
Gnocchi	White/Red Clam
Potato Dumpling	Fat-Free Butter
	Garlic & Oil
	Pesto
	Alfredo

Available Spicy, too!

Small	Large	Family
3.99 With	5.99 W/Salad	14.99
Garlic Bread	& Garlic	W/Salad &
	Bread	Garlic Bread

Add Veggie Topping.....	.99
Add Meat Topping.....	1.49
Add 4x Amount for Family Size	

**Toppings**

Veggies: Broccoli, Mushrooms, Onions, Peppers, Zucchini, Artichoke, Asparagus. *Meat:* Chicken, Meatballs, Italian Sausage, Steak, Shrimp

**Salads**

*(All with Romaine Lettuce and Tomatoes)*

	Small	Large
Santino's.....	2.99	4.69
Ham, Salami, Cheese, Cukes, Onions & Croutons		
Caesar.....	2.69	4.29
Croutons & Parmesan Cheese		
Antipasto.....	2.99	4.69
Salami, Mozzarella, Cukes, Onions, Croutons & Olives		
Greek.....	3.29	4.99
Beets, Feta Cheese, Cukes, Onions & Olives		
Tuna Caesar.....	3.49	4.99
Tuna Salad & Croutons		
Chicken Caesar.....	3.69	5.29
Grilled Chicken, Croutons & Parmesan Cheese		
<i>Choice of Ranch, Honey Dijon, Caesar, Non-Fat Italian, Greek, 1000 Island, Raspberry Vinaigrette or Blue Cheese Dressings</i>		

**Lunch & Dinner Favorites**

	Lunch	Dinner
Santino's Explosion.....	5.49	8.99
A low fat blend of Grilled Chicken and Angel Hair Pasta, a touch of Olive Oil & Non-Fat Butter, topped with freshly grated Parmesan Cheese. Fat 3.6g.		
Creamy Chicken.....	5.79	8.49
Lightly Breaded Boneless Breast of Chicken sautéed in Lemon and Wine sauce with Broccoli and a side of Pasta		
Chicken Limone.....	5.79	8.49
Lightly breaded boneless Breast of Chicken sautéed in Lemon and Wine Sauce with Mushrooms and a bed of Pasta		
Chicken Parmesan.....	5.49	8.29
Breaded Breast of Chicken, sautéed and covered with Marinara Sauce & Cheese with a bed of Pasta		
Artichoke & Basil Italiano.....	4.99	8.49
Sautéed Artichoke Hearts blended with Non-Fat Tomato & Basil Sauce. Served over homemade Angel Hair Pasta & lightly topped with Parmesan Cheese. Fat 1g.		
Chicken Marsala.....	5.49	8.99
Boneless Breast of Chicken sautéed with Mushrooms in a Garlic & White Wine Sauce served with a side Pasta.		
Maria's Veggie Lasagna.....	4.79	7.99
Veggie Lasagna served with Marinara Sauce		
Meat Lasagna.....	4.79	7.69
Homemade, with seasoned Turkey & Ricotta Cheese with Meat Sauce		
Stuffed Shells.....	4.99	7.29
Jumbo Shells stuffed with Shredded Cheese & Marinara Sauce		
Eggplant Parmesan.....	4.95	7.69
Layers of Eggplant, lightly breaded, with Cheese & Marinara Sauce		
Meat or Cheese Ravioli.....	4.99	7.49
Meat or Cheese filled Pasta Pockets served with Marinara or Meat Sauce		
Cheese Manicotti.....	4.89	7.69
Cheese filled Pasta Tubes with Marinara Sauce		
Cheese or Meat Tortellini.....	4.49	7.69
Pasta filled with Meat or Cheese, topped with Mozzarella		
Cajun Pasta & Chicken.....	5.49	9.49
Seasoned Pasta Noodles with spicy Chicken Strips & Sauce		
Scott's Garlic Lover's Pasta.....	4.99	8.49
Angel Hair Pasta sautéed in mounds of Garlic & Tomatoes. Fat 1.6g.		
Protein Lover's Pasta.....	5.99	8.99
Grilled Chicken or Steak with Mixed Vegetables on a bed of Pasta		

**House Favorites**  
*(Served with Salad & Garlic Bread)*

Sausage Francesca.....	8.69
Italian Sausage with seasoned Garlic and Oil and fresh Veggies mixed with Angel Hair Pasta	
Veal Parmesan.....	9.79
Breaded Veal sautéed and topped with our Marinara Sauce & Cheese with a side of Pasta	
Seafood Primavera.....	10.99
Shrimp & Seafood mix sautéed in Red or White Sauce over Fettuccine with Veggies	
Chicken Primavera.....	9.49
Chicken Breast sautéed in Red or White Sauce over Fettuccine and Veggies	
Shrimp Scampi.....	10.99
8 pieces of Shrimp sautéed in White Wine & Cream, served over Linguine	
Salmon & Eggplant Pasta.....	9.49
Seasoned Eggplant & Salmon tossed with Angle Hair Pasta, dressed with a seasoned White Wine Sauce, Garlic and a touch of Lemon, lightly topped with Parmesan Cheese. Fat 1.5g	
Scallops & Tomato Napoli.....	10.59
Fresh Scallops sautéed with Tomatoes & Garlic, topped with a slice of Lemon, served over homemade Linguine and lightly topped with Parmesan Cheese. Fat 2g	
Santino's Combo.....	8.69
Meat Lasagna & Eggplant Parmesan with side of Pasta and Meatballs	
Sausage & Chicken Fettuccine Alfredo.....	8.99
Fresh Sausage & Grilled Chicken in a creamy Alfredo Sauce with Fettuccine Noodles	

**Kid's Menu**  
*(All Include 1 Slice of Garlic Bread and a Santino's Surprise)*

Spaghetti with choice of Sauce.....	2.49
(Or Butter Substitute)	
Ravioli - Meat and/or Cheese.....	3.49
Jessica's Chicken Fingers (3).....	2.99

**WEDNESDAY**  
**KIDS EAT FREE**

*One Free with an Adult Dinner!*  
*(Maximum of 2 free meals. Not Valid with any other offer).*

**8" Subs With Chips**

Santino's Italian Sub.....	4.29
Ham, Salami, Cheese, Italian Dressing, Tomato & Lettuce	
Grilled Chicken.....	4.49
Boneless Chicken, Honey Dijon, Cheese, Tomato & Lettuce	
Italian Sausage.....	4.29
Served with Peppers, Onions, Meat Sauce & Cheese	
Veal Parmesan.....	4.29
Breaded Veal, Meat Sauce & Cheese	
Chicken Parmesan.....	4.29
Breaded boneless Chicken Breast, Marinara & Cheese	
Meatball Sub.....	3.99
Homemade Italian Meatballs, Meat Sauce & Cheese	
Steak & Cheese.....	4.29
Steak Patties with Cheese, Lettuce, Tomato & Steak Sauce	
Turkey & Cheese.....	3.99
Low fat Smoked Turkey with Lettuce, Tomato & Ranch Dressing	
Ham & Cheese.....	3.69
Served with Mozzarella Cheese, Lettuce, Tomato & Onion	
Jenny's Tuna Sub.....	3.49
Seasoned Tuna Salad, Cheese, Lettuce, Tomato & Onion	
Veggie Sub.....	3.29
Feta Cheese, Lettuce, Tomato, Onion, Seasonings & Olives	
Pepperoni & Cheese Sub.....	3.49
"Mounds" of Pepperoni & Cheese in a Meat Sauce	
1/4 Fat Free Burger.....	3.49
Golden Soy Burger topped with Fat-Free American Cheese. Tastes like a real meat burger	

**Side Orders**

Meatballs.....	1.49 (2)
Sausages.....	1.49 each
Garlic Bread.....	1/2 Loaf 1.99
Garlic Bread.....	Full Loaf 3.49
Side Salad.....	1.49
Chicken Fingers.....	4.99

**Free Dessert**  
*With Any Purchase Over \$10.*  
*One dessert per order*  
With Coupon • Expires 2-28-97

**Family Pasta Meal**  
*Feeds 7 Hungry People!*  
*Includes Salad & Garlic Bread*  
**\$12.99**  
Not Valid W/Other Offers. With Coupon • Expires 2-28-97

**15% OFF**  
**Entire Order**  
Not Valid W/Other Offers. With Coupon • Expires 2-28-97

**\$ Santino's Buck**  
**\$1.00 Off Any Dinner**  
Not Valid W/Other Offers. With Coupon • Expires 2-28-97



The "Original"  
**CURTAIN SHOPPE**  
 With a personal touch

- LACE
- RUFFLE
- CUSTOM

Over 1400 Wall paper Books including  
 Waverly & Schumacher Discounted at 30%

*Judy's Curtain Shoppe*  
 105 N. Center St. • Northville  
 (810) 348-3520



**FANTASTIC ALTERATIONS**  
 10% off your order of \$25 or more

I offer twelve years experience with clothing alteration service for men & women including everything from mending to major tailoring.

Pick up & delivery are available.

To add your name to our list of happy clients, call:



**(810) 449-7320**



**GREAT LOOKING CERAMIC TILE FLOORS BEGIN AT NOVI TILE SALES**

**INVENTORY REDUCTION SALE**  
 10 to 70% OFF IN STOCK CERAMIC TILES  
 WIDE SELECTION

We display the latest fashion; customer driven, in demand ceramic tiles—we inventory what we show

**LOW PRICE:**  
 We are direct buyers of imported and domestic ceramic tile and we pass the savings onto you!

**HIGHEST QUALITY**  
 We buy only standard grade materials so you know you are not getting second or builder grade

**PROFESSIONAL ADVICE**  
 Just ask! Our personnel have over 100 years of combined knowledge and experience of the ceramic tile business

*Guarantee Your Investment  
 Buy from the Pros at:*

❖ **NOVI TILE SALES** ❖

(810)473-0606  
 40500 Grand River, Novi  
 \*Sale Ends February 28th



Opens at 10 am  
 Now Serving Breakfast!

*Come Join Us at*  
**Pebble Creek Golf Course**

**Tavern & Grill**  
 (810) 437-5411

24095 Currie Road • South Lyon

**Satellite TV • Shuffle Board • Pool Tables**

Join us for our every friday fish fry

**\$5.95**  
 only

**Dinner includes:**

- Baked or Fried Cod • Cole Slaw
- French fries • Roll & Butter

Featuring a Full Winter Menu

# The SECRET is out!



**MAIL BOXES ETC.®**

## is in!

Announcing the convenient way for you to get 1-stop shopping for all your Postal, Business and Communication needs without waiting in long lines, from a staff that appreciates each and every customer.

### IT'S REALLY QUITE SIMPLE

Just visit the professionals at Mail Boxes Etc. where quick and friendly customer service is our **GUARANTEE TO YOU.**

#### FOR YOUR CONVENIENCE WE PROVIDE:

- UPS® Ground Service - Declared Value FREE up to \$100 and traceable
- UPS® - Overnight and 2nd Day Air - Guaranteed Delivery, Free Information
- Motor Freight - "Big or Small, We Ship It All."™ - Domestic and International
- Color Copies
  - Reduce or Enlarge Your Photographs
  - Enhance Your Business Presentations *With Color*
  - ETC., ETC., ETC.
- Copies - High Quality Reproductions - Full or Self Service
- Fax Services - Send and Receive, let our fax be your fax
- Printing - Business Cards, Letterheads, Envelopes, Labels and more
- P.O. Style Mailbox Service - Free 24-Hour Access plus Many Additional FREE Services
- Moving, Packaging Services - New Boxes (40 Sizes) Bubble Wrap, Loose Fill, Tape...
- Professional Packaging Services - For Your Convenience We'll pack Everything; from Fragile to not-so Fragile.

## COUPON SPECIALS

**FAST! COUPON EASY!**

**2 FOR 1 COPIES  
BLACK & WHITE**



MAIL BOXES ETC.

Crisp, Clean-Copies  
Limit 500  
Offer Expires 3-31-97

**FAST! COUPON EASY!**

**2 FOR 1  
COLOR COPIES**



MAIL BOXES ETC.

State of the Art  
Canon Color Copies  
Limit 100  
Offer Expires 3-31-97

**FAST! COUPON EASY!**

**FREE MAILBOX SERVICE**  
Rent A Private "P.O. Box" Style Mail Box For 3  
Months & Receive



MAIL BOXES ETC.

**3 MONTHS FREE**

First Time Box-Holder Only.  
Not Valid for Renewals  
Offer Expires 3-31-97

**Milford**

510 Highland Ave. 48381  
(810) 684-1141 (fax) 684-7045

**Northville - Downtown**

118 Main Centre 48167  
(810)344-1980 (fax) 344-4963

**Novi**

43422 West Oaks Drive 48377  
(810)347-2850 (fax) 347-1890

MAIL BOXES ETC. Franchised Centers are independently owned and operated. ©1995 Mail Boxes Etc.

**THE SOURCE**  
 Your South Lyon Area Internet Directory  
**www.slyon.com**  
 Local Web Sites - News - Weather  
 Lotto - Web Links - Local Listings  
 Hosted by DesignNet  
**810-486-1505**

**JANUARY & FEBRUARY  
 Specials**

**"World's Best"  
 Pedicure**  
**\$30<sup>00</sup>** Reg. \$35.00 First Time Clients  
 W/Dee Exp. 2-28-97

**Acrylics - Full Set**  
**\$28<sup>00</sup>** Reg. \$40.00  
**Acrylic Fills**  
**\$18<sup>00</sup>** Reg. \$25.00  
 W/Susan Exp. 2-28-97

**20% OFF**  
**All Perm & Color  
 Services**  
 W/Darlene Exp. 2-28-97  
 First Time Clients



**LINDA'S HAIR & MORE**  
 Full Service Family Hair Salon  
**(810) 349-0730**  
 43535 Grand River  
 Novi • 1/2 block west of Novi Rd.

**VALUABLE COUPON**

**30% OFF**  
**ON ALL INCOMING CUSTOM CLEANING\***  
 (Maximum Discount \$10.00)

HURRY  
 Limited Time  
 Offer  
 Exp. 2-26-97

**MAI-KAI**

Must Present  
 Coupon with  
 Incoming Order  
 Only  
 exp. 2-26-97

**cleaners**

**22136 NOVI RD.**  
 AT 9 MILE • OAK POINT PLAZA  
 (810) 344-8660

**47310 W. 10 MILE RD.**  
 AT BECK • BRIAR POINTE PLAZA  
 (810) 344-8266



**SALE - A - BRATION**

**ONE WEEK ONLY**

**NO PAYMENT  
 NO INTEREST  
 UNTIL 1998**  
 or we pay your  
 sales tax.





**SAVE  
 HUNDREDS**  
 on Bedrooms,  
 Living Rooms,  
 Mattresses...  
*Everything For  
 Your Home*

**WATERFORD/WEST BLOOMFIELD**  
 7570 COOLEY LK. RD.  
 (E. of Union Lake & Next to O.C.C.)  
**Ph. 810-363-2800**

**FURNITURE DIRECT**

*Always the Right Price!*

**HOURS:**  
 MON.-FRI. 10-9 SAT. 10-6 SUN. 12-5  
 90 Days Same As Cash  
  
 \$300 Minimum Purchase O.A.P.



# CLEARANCE SALE



**SAVE UP TO 60% OFF**  
**on Gold and Gemstone Jewelry**

**Closeout 14K Gold Jewelry**  
**From \$10.00/Gram**

*45% Off Suggested Retail Price on Discontinued*  
**Bulova, Seiko, and Citizen Watches and Clocks.**

**Save up to 40% Select Watch Bands.**  
**Sale Prices start at \$2**

**Save an additional 20% Off our already**  
**Guaranteed Lowest Prices on Selected Loose Diamonds**

**Save on hundreds of closeout Gold and**  
**Gemstone Rings, Bracelets and Pendants.**

**CLEARANCE SALE WILL BE**  
**FROM JAN. 20TH - FEB. 1ST.**

*Diamond  
Castle*

JEWELERS SINCE 1902



**(810) 442-2440 • 39955 Grand River • Novi**



**Sam's  
CAFE**

**\$5<sup>00</sup> OFF  
Any Meal Over  
\$15<sup>00</sup>**

Exp. 2-28-97

**10% OFF  
Any Meal**

Exp. 2-28-97

PHEASANT RUN PLAZA  
39777 Grand River  
Novi, Michigan 48050

474-8887

CARRY OUT - DINE IN

• EXCLUDING SPECIALS •



• NOVI •

**GRAND RIVER**

Just West of  
Haggerty

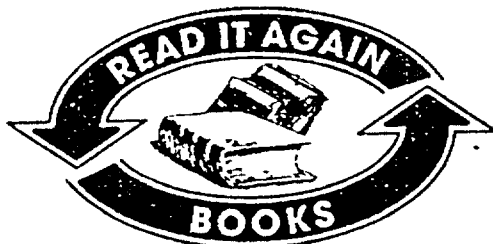
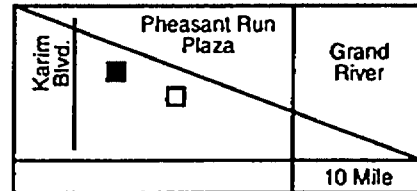

**NEW  
USED  
RENTALS**

**\$4 OFF** min. \$20 purchase  
**\$3 OFF** min. \$15 purchase  
**\$2 OFF** min. \$10 purchase

• USED BOOKS ONLY •

Cannot be combined w/any other coupon offer. Exp. 2-28-97

HOURS: Mon-Fri. 10-8  
Sat. 10-6, Sun 11-4  
39733 Grand River • Novi  
Pheasant Run Plaza

**810-474-6066**

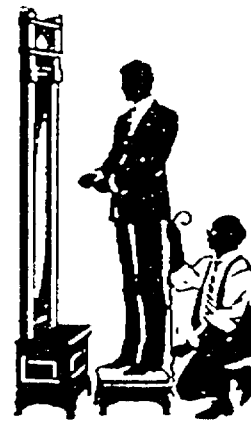

**Oxford**

TAILOR & CLOTHING

has a new home

visit us at 39863 Grand River  
Pheasant Run Plaza • Novi

For the perfect fit, we do expert alterations  
for Ladies and Men

**\$75<sup>00</sup> OFF**

Regular Price  
Suits or Sport Coat and Slacks

Thanks for your support over the last 10  
years. We look forward to continuing to  
serve the community.

**810-474-1904**

\*NOVI

Pheasant Run Plaza  
Grand River at Haggerty  
474-9777  
FULL SERVICE RESTAURANT



**CALL UP PAPA**  
For Carry Out or Delivery

**BIG SICILIAN**

**MON. & TUES.**

**MEDIUM PASTA**

A 12" x 18" Premium Sicilian  
Deepdish Pizza with Cheese and  
your choice of 2 items  
Additional items \$1.25 ea. h  
Double Cheese extra

**ONLY \$10<sup>52</sup>** Plus Tax

The pizza that made us famous  
Cheese & your choice of 1 item  
Add items \$1.25 ea  
Add \$1.00 for big Sicilian pizza  
Double cheese extra

**ONLY \$7<sup>99</sup>** Plus Tax

Italian delight! Fancy colored  
Noodles topped with Green Peppers,  
Onions, Tomatoes, Mushrooms  
Cauliflower, Broccoli, Parmesan  
Cheese & Italian Dressing

**ONLY \$4<sup>22</sup>** Plus Tax

All sites independently owned and operated  
Good at participating sites only. Del. Extra

All sites independently owned and operated  
Good at participating sites only. Del. Extra

All sites independently owned and operated  
Good at participating sites only. Del. Extra

**Home Is Where the Heart Is**

If your heart is looking for a new home  
Call a realtor who cares  
Call a Reliable agent

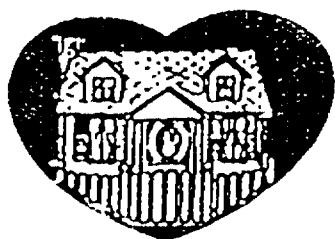

Mention this ad for a  
**COMPLIMENTARY  
Home Warranty\* with the Sale  
or Purchase of Your home.**

**810-476-0540**

**RELIABLE**  
Real Estate, Inc.  
RED CARPET  
REIM

\*some limitations apply, (a \$345.00 value)

**GA**  
**GINA AGOSTA**  
HAIR COLOR AND DESIGN

*To All First Time Clients*

*50% Off Haircuts... Hair Color  
Full Set of Acrylics... European Facial  
One Hour Make-Up Lesson...*

Valid with certificate  
Expires Feb. 28, 1997  
Not available on Saturdays

39831 Grand River • Pheasant Run Plaza  
• Novi • 810-477-2266

For those who enjoy the

*finer things* in life.

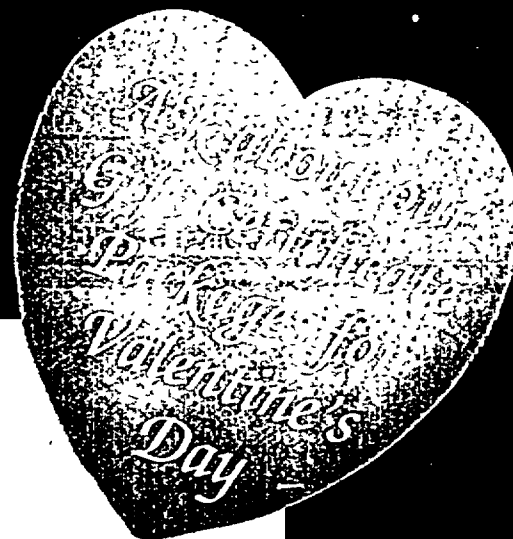

*Gift* CERTIFICATE



*GINA AGOSTA*  
HAIR COLOR AND DESIGN

39831 Grand River • Pheasant Run Plaza • Novi • 810-477-2266

## DON'T MISS OUR CARHARTT SALE!

CARHARTT  
SWEATSHIRTS  
**15% OFF**

BIBS, COATS,  
JACKETS  
**10% OFF**

SHIRTS  
any style or size  
**\$27.95**

T-SHIRTS  
**\$13.95**

### PURINA HORSE FEED ON SALE!

Sweet 12% ..... **\$6.85**

Horseman's Edge..... **\$7.45**

Omolene 200 ..... **\$9.95**

Equine Senior..... **\$9.95**

### BIRD HOUSES and FEEDERS

Bird Seed Available **15% OFF**

### PINE SHAVINGS

**\$3.99** 1-9 Bales **\$3.49** 10+ **\$3.29** 20+

### NOVI FEED AND SUPPLY

43963 Grand River • Novi • 349-3133

(Just West of Novi Rd.)

Mon.-Fri. 9-5; Sat. 9-2

### SOFTENER SALTS

40 Lb. Pellets

40 Lb. Red Out

**\$3.99**

**\$4.79**

Now  
Leasing



## South Lyon's Finest

1, 2 & 3 bedroom apts. - Garages Available

3 bedroom single family homes,  
full basement, 2 car attached garage



(810) **437-9959**

# BI-RITE AUTO SUPPLY

- National Brands at discount prices
- Complete line of new & rebuilt parts for all cars & light trucks
- Complete line of lawn & garden belts and spark plugs

*We turn brake drums & rotors*



BECK/ARNLEY  
WORLDWIDE



If we can't help you,  
nobody can.

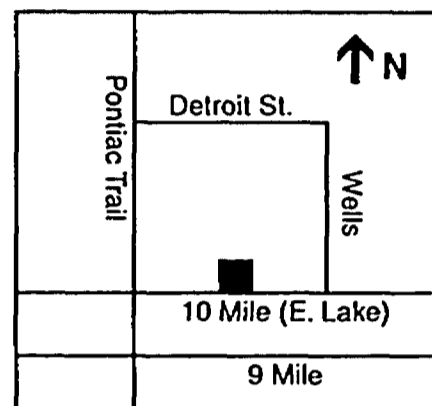

**437-6995**



125 E. Lake St. • South Lyon • 1 Block East of Pontiac Trail

Hours: Monday - Friday 8:30am - 7:00pm;  
Saturday 8:30am - 6:00pm; Sunday 10:00am - 3:00pm

FOR THE  
*Perfect  
Wedding*

## Barnstormer's Banquet Facility

Complete Custom  
Catering Packages

4 Newly Remodeled Banquet Rooms  
Our Elegant Oak Ballroom - up to 440 guests  
Gorgeous Cedar Ballroom - up to 350 guests  
Garden Room 2 - up to 120 guests  
Lounge - up to 190 guests.

What Ever The Event - We Cater To You!

From 10 to 1000 Guests

- Weddings • Meetings • Product Presentations • Seminars • Banquets
- Showers • Receptions • Trade Shows • Special Parties & Events
- Private Picnic Grounds

Call Today For  
An Appointment **(313) 449-0040**



### DAILY ENTERTAINMENT

Monday - Closed - New Game Room  
Tues. - Karaoke - Starts February  
Wednesday - Pool League  
Thursday - Pool, Darts, Foosball Tournaments  
High Energy Dance Music  
Fri. & Sat. - High Energy Dance Party 9pm-2am  
HOURS: Tues.-Thurs. 4:00 pm-12am  
Fri. & Sat. 4:00pm-2am

HAPPY  
HOUR  
4 PM - 8 PM



9411 E. M-36  
Whitmore Lake  
Just West of US 23

(313) 449-0040

### BARNSTORMER COUPON

Buy One Entree  
Get Second Entree  
50% Off

With Coupon Expires April 20, 1997

## 1997 Peaches & Cream BRIDAL EXPO

Sunday, February 16th  
Noon - 4 p.m.

at  
**BARNSTORMER'S**  
Catering & Banquet Center

FASHION SHOW STARTS AT 1:30 P.M.

Appetizers • Door Prizes

### PARTICIPATING COMPANIES INCLUDE:

- Colleen's Rose Garden Florist • In Good Taste
- Pure Country Girl • Rent & Rave Party Equipment
- Carriage House Designs • The Bridal Suite
- Per Your Request Cakery • Rawlinson Photography
- Princess House Crystal • Mary Kay Cosmetics
- Elite Sweets • Best Western • Royal Presige
- The Balloon Lady • Brighton Tux • Hearts & Flowers Wedding Boutique • Barnstormers
- & Many More

"Barnstormer's offers gourmet excellence & professional, courteous service."

(313) 449-0040

9411 E. M-36, Whitmore Lake

Follow US 23 to Exit 54 then to 1/4 mile west of US-23!

Mail in this coupon for your ONE FREE Bride's Admission  
with purchase of one

Brides' Name \_\_\_\_\_ Phone \_\_\_\_\_

Address \_\_\_\_\_ City \_\_\_\_\_ Zip \_\_\_\_\_

Wedding Date \_\_\_\_\_ Qty. \_\_\_\_\_ Enclosed \$ \_\_\_\_\_ at \$4.00 each

Tickets are \$4 in advance / \$6 at door • SEND TODAY! SHOW SELLS OUT EARLY  
Barnstormer's Peaches & Cream Bridal Show • 9411 E. M 36  
Whitmore Lake, MI 48189 • (313) 449-0040



2nd  
LOCATION

# THE BEVERAGE WAREHOUSE

MARKET PLACE  
"THE NAME SAYS IT ALL"  
24150 NOVI RD • NOVI

(Previously Erwin Farms) 349-2034  
Quality Is Our Speciality

LARGEST WINE  
VARIETY IN THE  
STATE OF  
MICHIGAN. BEST  
PRICES  
GUARANTEED!

We'll match any other store  
price with price proof.

**10% SENIOR  
CITIZEN  
DISCOUNT**  
WEDNESDAYS  
IN DELI, PRODUCE,  
& MEAT

- FINE WINES • BEER • POP  
• IN-STORE BAKERY • GOURMET DELI  
• FRESH FRUITS & VEGETABLES  
• FRESH MEATS • GOURMET SPECIALITIES  
**LET US DO YOUR CATERING!**

NOVI RD.	TEN MILE
NOVI RD.	BEVERAGE WAREHOUSE (Previously Erwin Farms)

A Fine Selection Of French Burgundy, Bordeaux, Loire, Rhone, ETC and Wines from several countries around the world and across the U.S. and Canada. • All Special Case Prices.

## WINE SALE



**Kendall Jackson  
Chardonnay**  
**\$10<sup>99</sup>** Limit 2 bottles



**Hess Select  
Chardonnay**  
**\$10<sup>99</sup>**  
87 Hess Select Chardonnay California 1994  
A fresh and flavorful white at a bargain. The apricot and pear flavors swirl around refreshingly on the palate. Drinkable now.  
Coupon Only • Expires 2-5-97



**Armenet  
DYNAMITE  
CABERNET**  
**\$15<sup>99</sup>** 750 Bottle  
Coupon Only • Expires 2-5-97



**IL Tasso  
Chianti 1994**  
**\$6<sup>99</sup>** Bottle  
Coupon Only • Expires 2-5-97



**Kunde  
Chardonnay**  
**\$12<sup>99</sup>** Bottle  
Coupon Only • Expires 2-5-97



**1994 Simi  
Chardonnay**  
**\$13<sup>99</sup>** Bottle  
Coupon Only • Expires 2-5-97



**Napa Ridge  
Cabernet  
Sauvignon**  
**\$6<sup>99</sup>** Bottle  
Coupon Only • Expires 2-5-97



**Lyeth  
Cabernet  
Sauvignon  
Meritage**  
**\$13<sup>99</sup>** Bottle  
**\$15<sup>49</sup>** Bottle  
Coupon Only • Expires 2-5-97



**J. LOHR  
ESTATES  
Cabernet  
Chardonnay**  
**\$9<sup>99</sup>** Bottle  
Coupon Only • Expires 2-5-97

## CHAMPAGNE SALE



**White Star Extra Dry  
MOËT & CHANDON  
CHAMPAGNE  
PERNAY-FRANCE**  
**\$24<sup>99</sup>**  
Coupon Only • Expires 2-5-97



**TAITTINGER  
FRANCE  
CHAMPAGNE**  
**\$25<sup>99</sup>**  
Coupon Only • Expires 2-5-97



**CHAMPAGNE  
Veuve Clicquot  
FRANCE**  
**\$29<sup>99</sup>**  
Coupon Only • Expires 2-5-97



**PERRIER-JOUËT  
GRAND BRUT**  
**\$23<sup>99</sup>**  
Coupon Only • Expires 2-5-97

## MEAT SALE

USDA Choice  
**Porterhouse  
Steaks**  
**\$3<sup>69</sup>** Lb.  
Save \$3.30 Lb.



USDA Choice  
**T-Bone  
Steaks**  
**\$3<sup>39</sup>** Lb.  
Save \$3.30 Lb.



USDA Choice  
**Ground Beef  
From Round**  
**\$1<sup>69</sup>** Lb.



**Skinless Boneless  
Chicken Breast**  
**\$1<sup>99</sup>** Lb.



# Pat Guy INTERIORS

- Designer Wallcoverings & Fabrics • Custom Window Treatments • Carpets, Vinyl, Ceramic & Wood Flooring
- Re-upholstery • Consultations • New And Existing Homes From Start To Finish

Whether you are looking for ideas, or have a project large or small, our seven professional designers can assist you at home or in our studio.



317 N. Lafayette • South Lyon

**(810) 486-5321**

Look us up on the Internet [www.rust.net/cabrose](http://www.rust.net/cabrose)

**ART SOURCE is having a SHATTERING SALE!**

**FREE GLASS**

on complete custom framing orders of \$75 or more. (Regular glass only)  
Orders must be placed by January 31, 1997



**ART SOURCE**

AFFORDABLE ART PICTURE FRAMING SPECIALISTS

126 MainCentre Building  
Downtown Northville  
(810) 348-1213

Mon.-Sat. 10:00-6:00 (Fri. 'til 8:00)

# The Most Advanced Protection You Can Get for Your Truck Bed!

ALSO GREAT FOR SNOWMOBILE TRAILERS

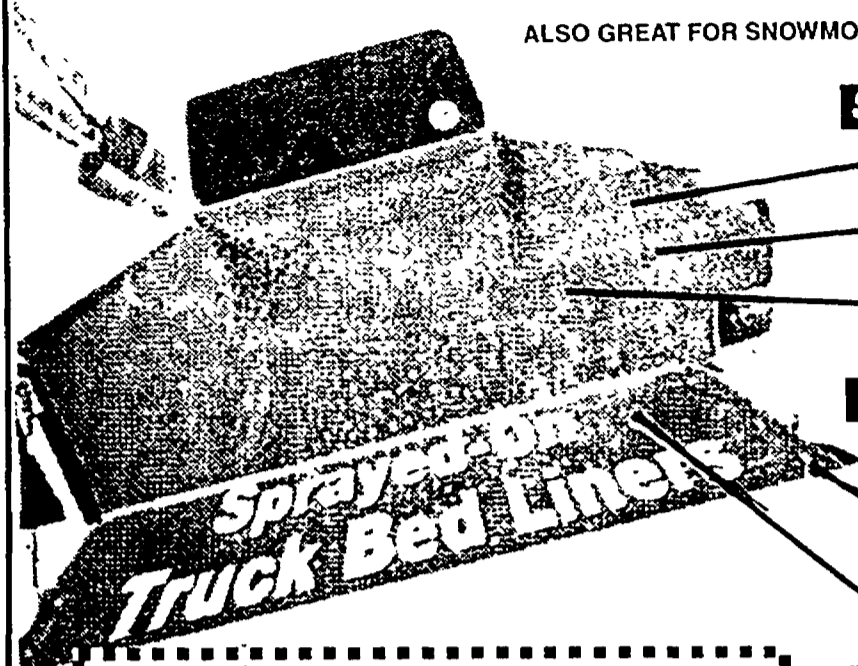

**See It!**

- Will not Warp, Crack or Split
- Contour Fit
- Withstands Weather Extremes

**Touch It!**

- Reduces Cargo Slippage
- Not a Paint...Up to 1/4" Tuff Stuff Polyurethane
- Resists Dents & Scratches

**Believe It!**

- Watertight Seal Eliminates Rust & Corrosion
- Reduces Noise & Vibration

**\$25<sup>00</sup> OFF ANY BEDLINER PURCHASE**  
OFFERS EXPIRES FEBRUARY 22, 1997  
**LIMITED TIME OFFER!**



**Rhino Linings**  
Sold for over a decade

RHINO LININGS OF S.E. MICHIGAN  
41787 Grand River • Novi, MI 48375  
(810) 380-RHINO  
(810) 380-7446

Also available from finer truck dealers in your area!  
LOCATED BEHIND A. KEAN PICTURE FRAMES

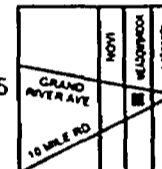

*Where Angels Learn To Spread Their Wings*

**Kiddie Academy**  
CHILD CARE LEARNING CENTERS

**Hurry! Register your child today!**  
**One Week FREE!!**

**SAVE UP TO \$156!**

Coupon required. Valid 90 days after enrollment.  
For new enrollments only. *One coupon per family*

- ◆ Care for Infants to 6-Year-Olds
- ◆ Full and Part-Time
- ◆ Year-Round Programs
- ◆ Preschool COMPUTER Learning
- ◆ Foreign Language Program
- ◆ Lunch & 2 Snacks Provided for Full-Time

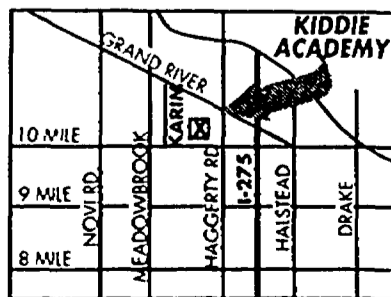

OPEN FROM 6:30 A.M. TO 6 P.M.  
MONDAY - FRIDAY

**(810)426-6789**

NOVI  
24300 Karim Blvd.  
SW. corner Grand River and Haggerty

• GOLD • DIAMONDS • MOVADO • SEIKO • MONT BLANC •

**50% OFF** New  
♡

*Must See!*

Hugs & Heart Kisses Bracelet  
14 kt. Solid Gold, yellow gold  
\$400 **Now \$199.99**

Contemporary Bangle • 14 kt Gold  
was \$700 **Now \$349.99**

*Perfect for your Valentine!*

Puffed 14 kt Gold Heart  
**Now only \$44.99**

Custom 14 kt Gold Heart Pendants  
starting from **\$39.99**

Custom Jewelry • Fine Time Pieces • Distinctive Gifts  
We turn dreams into reality using the finest quality gems.

**RAM Creations**  
Custom Jewelers

NOVI TOWN CENTER  
26024 Ingersol Dr. • Novi, MI 48375  
Phone (810)305-8686  
HOURS: Tues-Fri 11am-8pm  
Sat 11am-6 pm  
Sun 12-5 pm  
Closed Monday

• DIAMONDS • RADO WATCHES • SEIKO • MONT BLANC •

**\$100<sup>00</sup> REWARD WANTED**

**DEAD OR ALIVE**

Old, Tired, Worn Out Water Softeners

Now is the time to replace that old softener while it still has some value.

Country Water Treatment Inc. will give you **\$100<sup>00</sup>** trade in on a new "State of the Art" Water System. During the month of February 1996.\*

**ODOR FREE, IRON FREE, SOFT WATER**

A family owned business serving the area for over 30 years.

**Day or Evening Delivery** Salt Delivery, Bottled Water, Drinking Water Systems

**CALL NOW!**

(810) **437-9136** (810) **684-5869**  
(810) **229-1870** (313) **449-8722**

For **FREE** Estimate and Professional Water Analysis

**COUNTRY WATER TREATMENT**

13658 W. Ten Mile South Lyon

1 mile west of Pontiac Trail  
Monday - Friday 9-6; Saturday 9-4

\*Offer cannot be used with other coupons

**WE CARRY THE BEST.** And We Carry It Right To Your Home.

**\$1<sup>00</sup> Off Delivery**

**50% Off Installation**

of any Dura-Cube Salt of any Rental Unit

Ad must be presented at time of purchase with this ad. Absolutely expires 2-22-97. Cannot be combined with any other offer or discount. Cash sale only, no charges. Must mention coupon when ordering.

**BUY WHITE NOW!**

**96 CLOSEOUTS** AT TJ's Sales & Service

NO Interest Till 7-4-97      NO Payments Till 7-4-97



**White LT-15**

- 15 HP OHV Engine
- 42" Mower
- Cast Iron Front Axle
- 3 Gal. Fuel Tank
- 8 Speed Cruisematic Transmission

**\$1,399<sup>00</sup>**

\* \$39.00 per month



**White GT-2055**

- 20 HP V-Twin Engine
- Full Pressure Lubrication w/Filter
- 50" Shaft Driven Mower
- Hydraulic Lift
- Shaft Driven Dual Range Heavy Duty Transmission
- 3.5 Gal. Fuel Tank
- 3 Point Hitch
- 60" Shaft Driven Mower (optional)

**\$4,999<sup>00</sup>**

\* \$137.00 per month

**50% OFF Mower Blade Sharpening**

Offer Expires Feb. 28th, 1997

REPOSITION 196

50 MILE RD

196

7/3

7/3

194

**TJ'S SALES & SERVICE**

Just East of US 23 at Exit 50  
284 Six Mile Rd., Suite 100, Whitmore Lake MI 48189

**(313) 449-9900**

**WHITE**

OUTDOOR PRODUCTS

It's "Incredible"

See Dealer For Details

**Parkside Cleaners**  
**437-8353**

22645 Pontiac Trail • South Lyon

**15% Off**

**All Incoming Dry Cleaning Only!**

expires 2-6-97

Don't Forget Your  
 Valentine - February 14th

- Valentine Arrangements
- Greeting Cards
- Stuffed Animals
- Balloons & More

*Bakman*  
**FLORIST**

22880 Pontiac Trail • South Lyon  
 In King Plaza - Next to Rifles

(810) 437-4168

**50% Off**  
 A Mixed Bouquet  
 with this coupon  
 expires 2-8-97



*Whatever your price range, we have it!  
 From affordable to high fashion.*

**Royalty Jewelers, Inc.**

41714 W. 10 Mile at Meadowbrook • Novi  
 (Farmer Jack Center)

**(810) 347-7773**

Mon.-Fri. 11-7 Sat. 11-5

**Over 25 Years of Jewelry Experience -**

- Gold Chains and Charms
- Diamonds at True Discount Prices
- Watch Batteries & Bands
- Repairs Done on Premises by Expert Jewelers
- Pearl Restringing
- Gem Identification Service

**Special Prices  
 on all  
 Gold Bracelets  
 and  
 Color Stones**

**When You Purchase a  
 Diamond Ring You'll  
 Receive a Matching Band  
 FREE!**

Photo Engraving Available on Gold or Silver - Laser Engraving  
 Perfect Gift That Will Last a Lifetime!

**WATCH BATTERIES**  
**\$1.99**  
 Installed while you wait  
 Limit 2

**30% OFF**  
**BULOVA**  
**WATCHES**



Susannah Holstein and Kate

*Elizabeth's Bridal Manor*

Dear Elizabeth . . .  
 I can't thank you and your staff enough  
 for the professional and caring way you  
 treated Kate and her bridal party.  
 Everyone did their utmost to please us.  
 Finally to you Elizabeth for being there  
 for us - it meant a great deal to me -  
 Thank You! I could relax and know every-  
 one was in good hands.  
 Why anyone would go anywhere else for  
 Wedding dresses I can't understand.

Thank you -  
 Sincerely  
 Susannah Holstein

402 S. Main • Northville  
**(810)348-2783**  
 (2 blocks north of West 7 Mile Rd.)

\*Not valid with any other  
 previous purchase or offers

<b>HOURS:</b>	
Mon., Wed. & Thurs.	11-9
Tuesday.....	11-5
Friday.....	11-6
Saturday	Sunday
10-5	12-5

*Bring your Mom and Receive 15% Off Your Bridal Gown\**



Wave  
goodbye to  
expensive  
waves.

576 N. Lafayette • South Lyon  
Huntington Square Plaza

**486-1661**

# Fantastic Sams

Hours: Monday - Friday 9-8; Saturday 9-5

## PERM PLUS

- Shampoo
- Precision Cut
- Quality Perm
- Style

# \$32.95

regular \$38

Expires 2-23-97 • Longer Hair Extra *Fantastic Sams*

**Stop in and take advantage of our  
Paul Mitchell Specials!**

Each salon independently owned and operated. Fantastic Sam's International, Inc. 1994

# No Time To Read?

Listen to best-selling authors while you commute, exercise, etc.  
Over 4,000 titles available

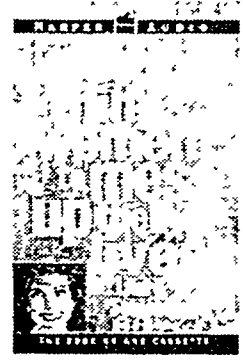

MICHAEL CRICHTON

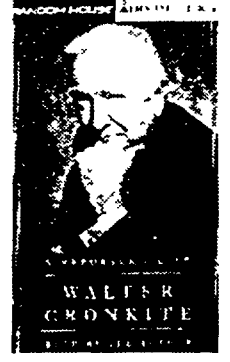

WALTER CRONKITE

## FREE AUDIO BOOK!

### Rent 1, Get 1 Free

New customer only  
With Coupon • Of Equal Or Lesser Value • Expires 3-1-97

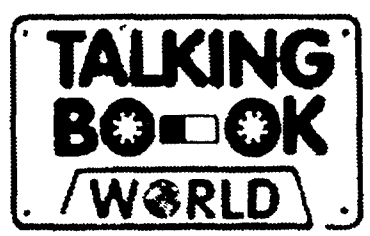

## Audio Book Rental & Sales

**HOURS** Mon-Fri 10am-8pm  
Sat 10am-6pm  
Sun 12 Noon-6pm

24291 Novi Rd.  
North of 10 miles, Pine Ridge Center

**810  
449-9100**

# TORO WHEELHORSE SALE!

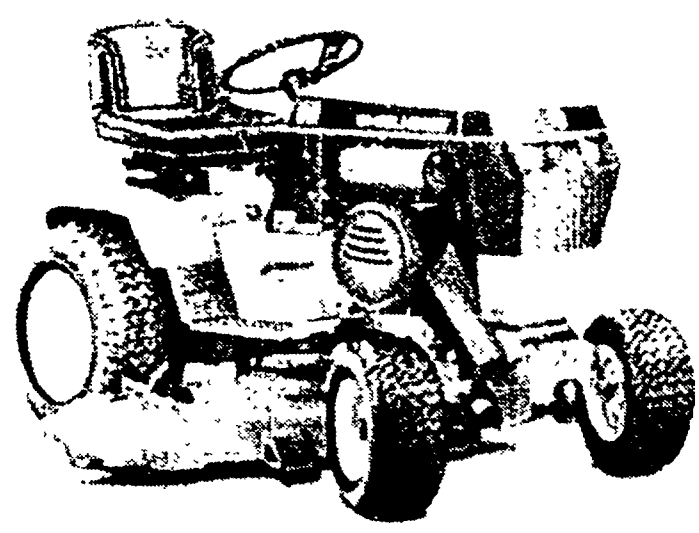

**\$250 Rebate**  
On All Wheelhorse  
300, 400, 500 Series  
Expires Feb. 28, 1997

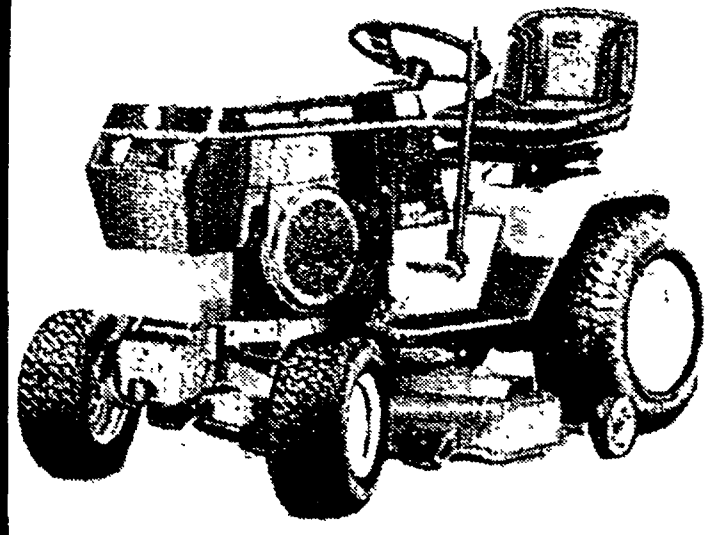

**LOW  
9.9%  
Financing**

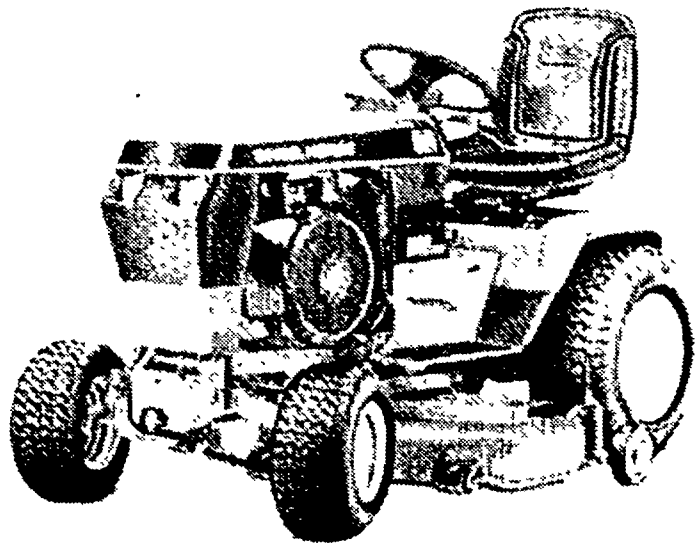

**TORO** Wheel Horse®  
Tractors & Riding Mowers

**When you want it done right®**



# Cougar CUTTING PRODUCTS & SUPPLY, INC.

Hours:  
M - 7:30-6:00; T-Fr 7:30-5:30  
Sat. 9-3 pm

"Where Quality Counts"  
**(810) 348-8864**

46845 12 Mile Rd., Novi  
@ I-96 & Beck Rd.





# GRAND RIVER EQUINE FEEDS

51680 Grand River • Wixom • (810) 348-8310  
Hours: Mon.-Fri. 8a.m.- 5p.m.; Sat. 8:00a.m.-2:00p.m.



**Horse Feed • Hay • Straw**  
**Quantity Price Breaks Available**  
*While You Wait!*

- Dog & Cat Food • Horse Supplies • Straw
- Wild Bird Seed • Wood Shavings • Poultry Feed

**BON-A-ROSE**

Italian



American

**RESTAURANT**

56808 Grand River • New Hudson

(810) **437-8788**

Hours: Lunch Only Tues., Wed., Thurs. 11-3  
Lunch & Dinner Only Fri. 11-10;  
Dinner Only Sat. 4-10

**Please come in and enjoy a delicious  
homemade meal and we will treat  
you to FREE dessert & coffee**

must present this ad • offer good only with purchase of adult meal • up to  
4 offers per ad • expires 3-10-97 • Friday and Saturday night only

**Every Tuesday  
Seniors 20% Off Lunch**



**BRIARPOINTE  
VETERINARY CLINIC**



**FEBRUARY IS NATIONAL PET  
DENTAL HEALTH MONTH**

During this month we are offering a

**Dental Check-Up at**

**NO-CHARGE**

and this \$10.00 certificate towards a dental  
prophylaxis. Take advantage of this  
opportunity to give your dog or cat the dental  
care they need.

Expires 2/28/97

**(810) 449-7447**

47330 Ten Mile • Novi  
(corner of 10 Mile & Beck)

**VCR  
REPAIR  
FREE  
ESTIMATES**

**Rent-A-Flick  
VIDEO  
SUPERSTORE**

**ALL  
GENERAL  
TITLES  
\$1.50**

**47230 W. 10 Mile Road  
Novi, Michigan 48374  
Corner of 10 Mile & Beck Road  
810-349-2000**

**Mon.-Thurs.  
2 for 1  
Rentals**  
(General Movies Only)

**"The Video Dozen"  
Rent 12 get 1  
FREE**  
ALL DAY, EVERYDAY

**Rent Nintendo 64  
&  
Play Station  
Systems**

**ADMIT 1**

**Rent (1)  
Get (1)  
FREE**

Some Restrictions Apply

Exp. 3-1-97

**FREE  
KIDVID  
RENTAL**

Exp. 3-1-97

**\$1.00 OFF  
Any  
Rental**

(Does Not Include Games)

Exp. 3-1-97

**ADMIT 1**

**NEW LOCATION!**

**Coe's CLEANERS** 155 E. Commerce Suite 100  
 (810) 685-3121 or (810) 685-0770

**HOURS:**

Mon.-Fri. 7am-7pm; Sat. 9am-5pm

- Professional Dry Cleaning • Shirt Laundry • Alterations • Shoe Repair
- Leather Cleaning & Repairs
- Wedding Dress Cleaning & Boxing

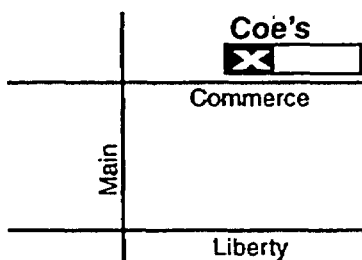

**25% OFF**

Incoming Dry Cleaning Only

Expires 2-8-97

**Coe's CLEANERS**

**QUICKSILVER**

PRINTING CENTER

120 N. Mill St. • South Lyon, MI 48178

810-486-1777 • Fax 810-486-1780

- DESKTOP PUBLISHING
- ENVELOPES
- BUSINESS CARDS
- LETTERHEAD
- CONTINUOUS FORMS
- FORMS
- CHECKS
- AND MORE...

*We'll make a personal visit to discuss your printing needs!*

**Great News!**

**COUGAR CUTTING PRODUCTS NOW CARRIES A FULL LINE OF CARHARTT WORK & CASUAL CLOTHING!**

**\$10<sup>00</sup> Off SALE PRICE**

on selected Jackets & Sweatshirts

(Styles 71218, JR105, JR106)

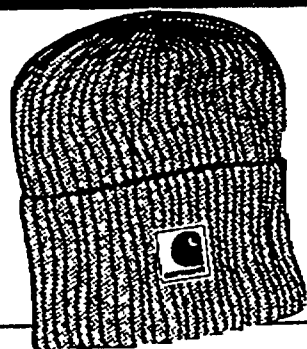
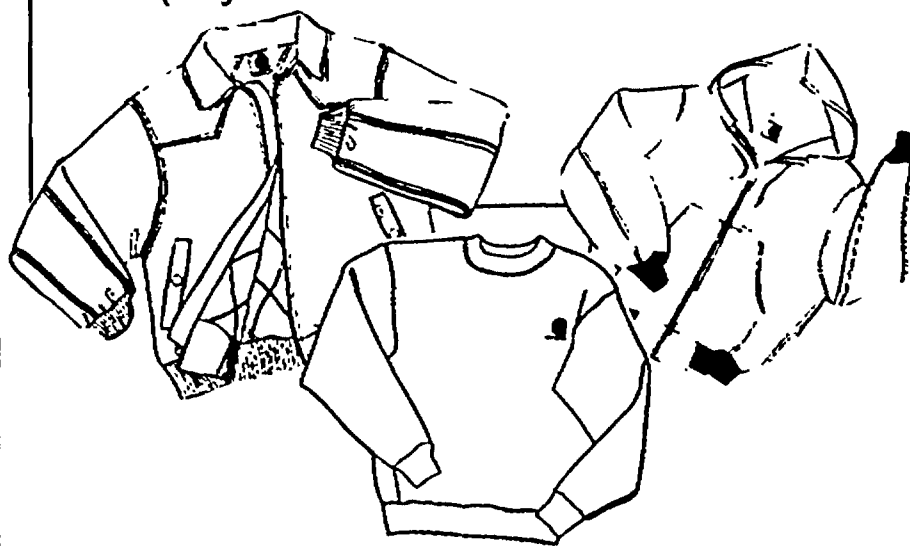

**WARM KNIT WATCH CAPS**

**\$4.99**

Style MV056

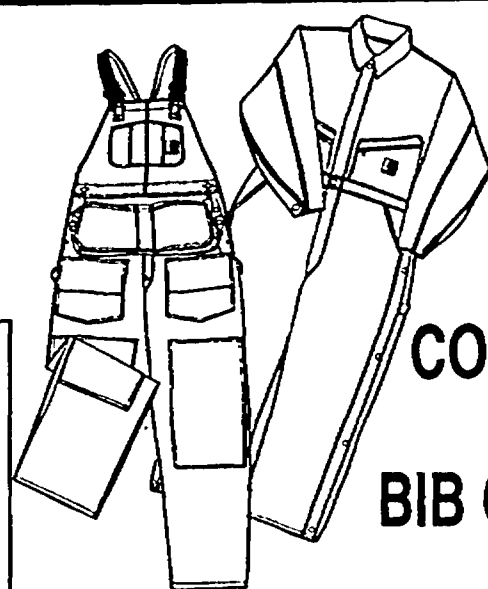

**COVERALLS AND BIB OVERALLS**

On Sale Starting At

**\$42.99**

Style 6FB

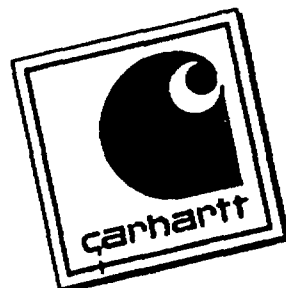

**Original equipment for the American worker.™**



**Cougar CUTTING PRODUCTS & SUPPLY, INC.**

Hours:  
M - 7:30-6:00; T-Fr. 7:30-5:30  
Sat. 9-3 pm

"Where Quality Counts"

(810) **348-8864**

46845 12 Mile Rd., Novi  
@ I-96 & Beck Rd.



**ANEW**  
THERAPEUTIC  
MASSAGE

Give Someone  
You Love...  
Something They'll  
Love!!!

**20% OFF**  
Valentine's Day Gift Certificates

with this ad (Standard & Deluxe Only)

145 E. Cady  
Northville  
(810) 449-2639 Rita Wightman, CM



*The Kitchen Witch*

"A Unique Kitchen Shop"

We're Having A SALE

A Large Selection  
of Cookbooks **50% OFF**

The Kitchen Witch

118 E. Main St.  
Northville, MI 48167  
348-0488

**25% OFF** Farberware  
Millenium

• ALL CLAD • LeCREUSET • BERNDES

10% OFF THESE BRANDS OF OPEN STOCK COOKWARE\*

\*excludes special orders & promotional sets



BUY 1 SPECIALTY  
BREAD  
GET 1 HALF-OFF  
BAKED FRESH IN STORE  
7 DAYS A WEEK

- Cinnamon Raisin
- Cheddar Cheese
- Sourdough
- Garlic
- Cinnamon Apple
- Cinnamon Swirl

CATERING  
MICRO BREW BEERS  
FINE WINES  
810-305-9702  
fax 810-305-9910  
Corner of 10 Mile & Beck Road • Novi  
In The New Briarpointe Plaza  
47210 W 10 Mile

**PIZZA SPECIAL**

OUR FAMOUS  
CHEESE & PEPPERONI  
"YOU-BAKE"  
2 LARGE  
**\$13.98** exp. 2/28/97

OUR FAMOUS  
CHEESE & PEPPERONI  
"WE BAKE"  
2 LARGE  
**\$15.99** exp. 2/28/97

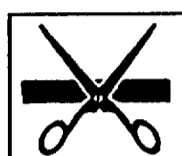

**Jerry's Family  
Barber Shop**

Across from New Hudson Food Market



Also Ladies Haircuts

Closed Mondays

One FREE cup of coffee w/haircut

**Haircuts** All long hair \$2.00 extra

**Senior Citizen**  
First time customers only  
(not working)  
**\$7.00**  
**\$1.00 OFF**  
coupon not valid on Sat.  
expires 3-1-97

**Children's**  
First time customers only  
12 Years & Younger  
**\$8.00**  
**\$1.00 OFF**  
coupon not valid on Sat.  
expires 3-1-97

**Adult Men**  
First time customers only  
**\$10.00**  
**\$1.00 OFF**  
coupon not valid on Sat.  
expires 3-1-97

**Women's**  
First time customers only  
**\$12.00**  
**\$2.00 OFF**  
coupon not valid on Sat.  
expires 3-1-97

Hours: Thurs. 9-7 • Tues., Wed. & Fri. 9-6; Saturday 8-4; Closed Sunday and Monday  
56461 Grand River • New Hudson (810) **437-7355**

**Prom Preview Sale**

**Early Bird Special**

Purchase or order your prom gown before  
February 28th and receive 10% off

**Prom Preview:**

Sunday Feb 2 - 5:30:00 pm

Call for your Reservations  
Enter our drawing to receive  
a free prom gown

\*must be present to win

*Elizabeth's Bridal Manor*

402 S. Main • Northville • 348-2783  
(2 blocks North of West 7 Mile Rd.)

Hours	
Mon., Tues., Thurs.	11-9
Tuesday	11-5
Friday	11-6
Saturday	10-5
Sunday	12-5

teacher apple teacher apple teacher apple teacher apple

**Building your science fair project?**  
See us for

**15% OFF**

All science kits, books & supplies  
with this coupon expires 2-14-97

**The Purple Cow**  
Educational toys for all ages

570 N. Lafayette  
Huntington Square, South Lyon  
(810) 486-3890

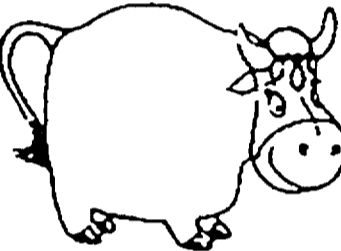
 3603 E. Grand River  
Wal-Mart Plaza, Howell  
(517) 545-0176

teacher apple teacher apple teacher apple teacher apple

**Winter Specials HOMELITE®**

32:1 Mix 6 pack <b>\$5.95</b>	Files <b>94¢</b>	Bar & Chain Oil Retail \$8.29 Gal. <b>\$3.77</b>
-------------------------------------	---------------------	---

**Saw Chain Specials**

14" 53L \$20.79	\$13.00	Super Chisel
16" 59L \$22.79	\$15.00	Pro Chain
20" 70L \$25.95	\$19.00	available at reduced prices



**Super XL Big Red Chain Saw**  
Retail \$469.00  
Sale **\$329.00**  
• 20" bar & chain • 3.5 cubic inch engine • 13 lbs. weight • Manual override

**New Hudson Power**  
53535 Grand River at Haas, 2 miles east of Pontiac Trail  
(810) **437-1444**

**1997 Pre-Season Specials**  
**SAVE SAVE SAVE**  
Our Tractor Comes with a Lifetime Warranty!



**New 1997 Models!** **Spring Tune-up Specials!**

LIFETIME WARRANTY **TOP™** Financing Available

**New Hudson Power**  
53535 Grand River at Haas, 2 miles east of Pontiac Trail  
(810) **437-1444**  
Largest Ingersoll Dealer In The U.S.!

22750 Pontiac Trail • South Lyon  
Between 9 & 10 Mile  
(810) **437-4800**

**Tuffy Auto Service Centers**

**1997 MID WINTER SPECIALS!**

<b>50% OFF</b> Bendix BRAKE PADS AND BRAKE SHOES Lifetime Warranty on Pads & Shoes • Free Inspection/Estimate • Turn Rotors or Drums • Check all Hoses & Seals • Install New Pads or Shoes • Check Master Cylinder • Repack Non-Drive Wheel • Semi-Metallic Pads Extra Bearings Most Cars & Light Trucks Good at South Lyon location only expires 3-15-97	<b>50% OFF</b> Tuffy Auto Service Centers PREMIUM OR MSL MUFFLERS Lifetime Warranty Most Cars & Light Trucks Good at South Lyon location only expires 3-15-97	<b>FREE SHOCK OR STRUT</b> MONROE SENSATRAC BUY 3 STRUTS OR SHOCKS & GET 4TH FREE equal or lesser value Good at South Lyon location only expires 3-15-97	<b>\$16.95</b> Kendall MOTOR OIL OIL CHANGE INCLUDES FILTER Good at South Lyon location only expires 3-15-97
--	---	---	--

**We also specialize in**

**HUNTER Engineering Company**  
Computerized Alignments

**MOOG** Front End Suspension Repairs

**INTERSTATE BATTERIES**

**Ask Us About**

- Heating & Air Conditioning
- Radiators
- Hoses
- Belts
- Lights
- Wiper Blades
- Tune ups
- Starting & Charging
- Tires & Tire Repairs
- Axle Shafts
- CV joints

# Attention Golfers!

**INCREDIBLE '2 FOR 1'  
GOLF OFFER  
AT LOCAL COURSES!**

Act now on this great golf and dining special for any one of the featured courses. Worth over \$200.00 each! Valid through 1997.

Only **\$25.00** per certificate

Each certificate entitles you or your guest to complimentary golf and dining when a second of equal or greater value is purchased.

Choose from:

- \* **WHISPERING PINES** - Pinckney  
5 FREE ROUNDS OF GOLF  
AND 1 FREE BONUS 9 HOLE ROUND
- \* **HICKORY CREEK** - Canton  
5 FREE ROUNDS OF GOLF  
& FIVE FREE BUCKETS OF BALLS
- \* **CAPTAIN'S CLUB** - Grand Blanc  
5 FREE ROUNDS OF GOLF, 5 FREE LUNCHES  
& 5 FREE DINNERS
- \* **BRENTWOOD** - White Lake  
5 FREE ROUNDS OF GOLF, 5 FREE LUNCHES  
& 5 FREE DINNERS
- \* **REDDEMAN FARMS** - Chelsea (just W of Ann Arbor)  
5 FREE ROUNDS OF GOLF, 5 FREE LUNCHES & 5 FREE DINNERS
- \* **RUSH LAKE** - Pinckney / **REDDEMAN FARMS 'COMBO CARD'**  
5 FREE ROUNDS OF GOLF AT EACH COURSE  
& 5 FREE LUNCH OR DINNERS
- \* **HIGHLAND HILLS** - 5 FREE 18 HOLE  
& 5 FREE 9 HOLE ROUNDS OF GOLF  
& 5 FREE LUNCHES

Call (810) 669-8815 or (800) 838-5294  
or send check or money order to  
Dickenson Sawyer, Inc.

P.O. Box 396, Milford, MI 48381

Please specify which certificate you wish to order!  
Certificates are not available at the course



**Dazzling  
Diamond Dogs  
Professional Pet  
Grooming**  
22312 Pontiac Trail  
**486-2555**  
Do-it-yourself pet  
wash available

New Clients Only!  
**\$4.00  
OFF**  
Full Grooming  
must present coupon  
expires 2-28-97

## SOUTH LYON CYCLE

### WINTER BIKE SALE

#### Big Savings

ON POPULAR MODELS FROM  
TOP BRANDS INCLUDING:

**SCHWINN**

**GIANT**

**DIAMONDBACK**

### USE OUR SPRING LAYAWAY

**MOUNTAIN BIKES**

as low as **\$189.95\***

**SUSPENSION BIKES**

as low as **\$399.95 - \$599.95\***

\* while supplies last

**SCHWINN BOYS & GIRLS**

**20" WHEEL BIKES**

**\$129.95**

All Bicycles Include:

- FULL Warranty
- FREE Assembly & Adjustment
- FREE Tune-up after 30 riding days

Also in Stock:

- Winter Trainers • Winter Clothing
- Studded Winter MTB Tires

209 S. Lafayette - downtown South Lyon  
2 blocks south of 10 Mile

**437-0500**

Bertch Cabinet Mfg. Inc. Bertch Cabinet Mfg. Inc. Bertch Cabinet Mfg. Inc.



## Bertch Cabinet Mfg., Inc.

PLAN YOUR NEW  
BATHROOM WITH  
BERTCH QUALITY CABINETS



all in  
matching  
shades

**50% off**

All  
Bertch  
Oak Cabinets

Offer Good  
Through  
FEB. 2, 1997

# MATHISON'S

Kitchen, Bath and Plumbing Showrooms

6130 Canton Center      31535 Ford Rd.      28243 Plymouth  
Canton • 455-9440      Garden City • 422-3888      Livonia • 522-5633

HOURS: Mon.-Fri. 8-9; Sat. 9-6; Sun. 11-3

Bertch Cabinet Mfg. Inc. Bertch Cabinet Mfg. Inc. Bertch Cabinet Mfg. Inc.

## Need an Engine?

3 Day Service in Some Applications

Check Our Prices  
& Quality

### Remanufactured

INSTALLED, EXCHANGED OR

CARRY-OUT

Cars, Vans, Pick-Ups &  
Heavy Trucks

Standard 12 Month

Unlimited Mileage Warranty

Extended Warranties Available

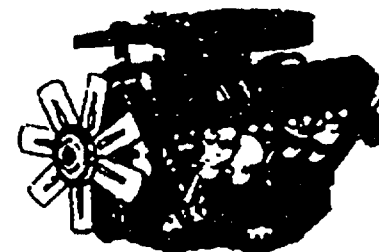

**\$100<sup>00</sup>**

**OFF**

With This Ad

## INDEPENDENT AUTO & TRUCK SERVICE

**(810) 360-4400**

4370 Haggerty Road • Walled Lake • Michigan • 48390

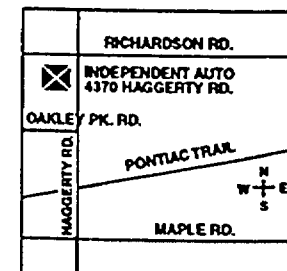

## Mayville Sales & Service, Inc.

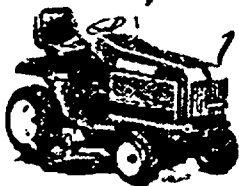

11417 South Hamburg Road  
Hamburg, MI 48139  
(810) 231-1110



*Selling and Servicing Quality Outdoor Power Equipment  
Since 1966*

### PRE SEASON CHECK-UP

*Now Thru March 15, 1997*

Mayville's factory trained mechanics will perform the following professional service -

Flush and clean fuel system • Replace fuel filter • Fill gas tank and stabilize fuel • Change engine oil Proper disposal of fuel and engine oil • Replace Spark Plug • Clean air filter • Adjust carburetor settings (if applicable) • Adjust valves (if needed) • Check and set engine RPM • Sharpen Blade(s) • Adjust and lube cables/check operation • Final operation and safety check • Power wash unit • Clean deck and engine blower housing • Call with estimate if further repairs are needed

#### Push & Self-propelled ROTARY MOWERS

Checkup  
Special  
**\$49<sup>95</sup>**

*Includes Pickup and Delivery!!!  
Limited Area Call For Details*

#### TRACTORS & RIDING MOWERS

Checkup  
Special **\$119<sup>95</sup>**

*1/2 Price on Pick-up & Delivery.  
Includes Pickup and Delivery!!!  
Limited Area Call For Details*

CALL TODAY FOR PICK-UP/DELIVERY APPOINTMENT

(810) **231-1110**

*After The Sale It's The Service That Counts*

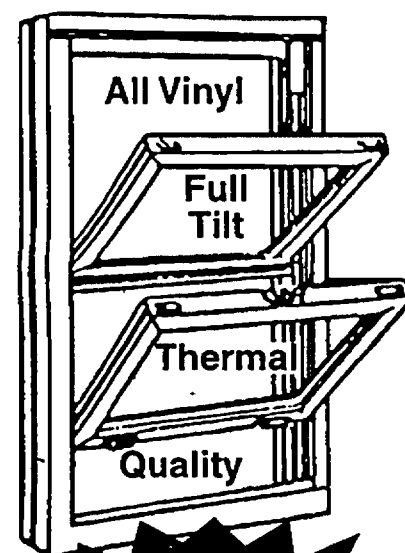

## Low Low Prices on great windows

We Manufacture the most popular thermal vinyl windows. Any size, any style. Buy 1 or 100 and save.

**We accept  
Visa &  
Mastercard!**

Quality Backed  
by **SunShield**  
Alcoa VINYL COMPOUND



Lifetime Warranty

**Call For FREE In-Home Estimate**

24 Hr. Message Center **Factory**

1-800-327-3159

437-5870

## SUNAIRE WINDOW MANUFACTURING CO.

7936 Boardwalk • Brighton, MI

Member of Better Business Bureau

# Paint 'n Paper Plus

*Finishing Touches*

117 N. Lafayette • South Lyon

(810) **486-4910**

*The Best Paint . . .  
and so much more!*

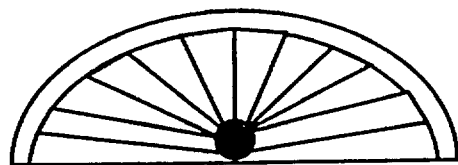

Hunter-Douglas  
and  
Kirsh Window  
Treatments  
up to

**70%  
OFF**

- Faux Finish Classes (now forming)
- Wallpaper - Great Selection!
- Custom Soft Window Treatments
- Decorating Consultation Available
- Antiques
- Home Accessories
- Gifts, Cards & Candles

**50% OFF**  
Remaining Christmas Items

**\$3.00 OFF**  
per gallon

All Benjamin Moore best  
interior Regal Paints.



A Stroke Of Brilliance.

valid thru 2/8/97

# **WE'RE FIGHTING FOR THE CHILDREN.**



**IT'S TOUGHER THAN EVER TO RAISE A CHILD RIGHT. AND PARENTS ACROSS AMERICA NEED ALL THE HELP THEY CAN GET. WHICH IS WHY MORE THAN 350 ORGANIZATIONS ARE NOW UNITED TOGETHER TO BE A STRONGER FORCE THAN THE PROBLEMS FACING OUR FAMILIES AND OUR CHILDREN.**

**WE'RE THE COALITION FOR AMERICA'S CHILDREN. AND WE KNOW HUNDREDS OF WAYS, BIG AND SMALL, YOU CAN HELP STRUGGLING FAMILIES IN YOUR COMMUNITY.**

**CALL US AT 1-888-544-KIDS OR REACH US ONLINE AT [WWW.KIDSCAMPAIGNS.ORG](http://WWW.KIDSCAMPAIGNS.ORG). WE'RE FIGHTING FOR THE CHILDREN. WHOSE SIDE ARE YOU ON?**

Generous support is provided by the AT&T Foundation

The Coalition for America's Children 

# Victoria's Place



We'll be closing our doors after 12 yrs. in downtown Northville on February 1st.

**50 - 70%  
Storewide**

**Thank you Northville  
for all your support.**

**118 E. Main • Northville**

\* Additional 30% off sale merchandise  
\*\* Excluding all handcrafted items

**"STOREWIDE SALE"  
10% OFF  
JAN 23 - FEB 1  
PRESENT THIS AD  
OTHER ITEMS AT GREATER SAVINGS**

- BRIO • Safari • Breyer
- Gund • Playmobil
- Applause • Darda • Tomy
- Thomas Tank • Ravenburger
- Geo Safari • Wood board Games, 3D & Other Puzzles
- Unique, Unusual and Educational Toys & games for All Ages

*Ultimate*  
**TOYS & GIFTS**

**107 N. Center St., Northville**  
Hours: Mon.-Sat. 10:00 a.m. - 5:30 p.m., Fri. 10:00 a.m. - 7:00 p.m.  
**(810) 305-9990**

Name \_\_\_\_\_

Address \_\_\_\_\_

Phone \_\_\_\_\_

Good Thru  
1/25/97

# Carter

*Lumber*

PLUMBING • ELECTRIC • HEATING

**65 YEARS  
SINCE 1932**



#3 PINE BOARDS			
	1"x6"	1"x8"	1"x12"
6'	\$1.90	\$2.70	\$5.41
8'	\$2.53	\$3.61	\$7.21
10'	\$3.16	\$4.51	\$9.01

other widths & lengths available in pine boards

POPLAR BOARDS			
	1"x2"	1"x4"	1"x6"
4'	\$1.59	\$3.09	\$4.89
5'	\$1.99	\$3.89	\$6.09
6'	\$2.39	\$4.69	\$7.39

(other sizes & length available)

#2 PINE BOARDS			
	1"x4"	1"x6"	1"x8"
6'	\$2.30	\$3.52	\$5.21
8'	\$3.07	\$4.70	\$6.95
10'	\$3.84	\$5.87	\$8.69

OAK BOARDS			
	1"x2"	1"x4"	1"x6"
4'	\$2.19	\$4.69	\$7.89
5'	\$2.79	\$5.89	\$9.79
6'	\$3.29	\$7.09	\$11.79

**THE LASTING LOOK OF  
Dutch Boy**  
CONFIDENT  
INTERIOR  
LATEX FLAT **\$9.89**  
7311 1 GAL.

CONFIDENT  
INTERIOR  
LATEX  
SEMI-GLOSS **\$13.59**  
7315 1 GAL.

**NON-SPATTERING  
CEILING PAINT**  
**\$12.99**  
7322 1 GAL.

- Spatter resistant
- Hides minor imperfections
- Available in bright or soft white

**MINWAX**  
**POLYSHADES**  
• Stain and polyurethane in one easy step  
**\$10.79**  
7520 1 QT.

**WOOD FINISH**  
• Available in 16 rich shades  
• Penetrated deep into wood fibers  
**\$6.99**  
7467 1 QT.

**POLYURETHANE**  
• Long lasting durable finish  
• Easy to apply, easy care  
**\$9.39**  
7542 1 QT.

**• Complete Service • Large Selection • Quality Products • Affordable Prices**



• Quantities may be limited • Not responsible for typographical errors • Pictures may vary from actual product • Not all items stocked at all stores • Prices may be subject to change with changing market prices • Details on product warranties are available at the store

**We Deliver**

Apply today for your Carter Credit Card

**Hours: Weekdays 7:30 a.m. - 6:00 p.m.; Saturday 7:30 a.m. - 4:00 p.m.; Sunday 9:00 a.m. - 3:00 p.m.**

# Carter Lumber

1451 N. Territorial Rd., Whitmore Lake, East of US-23

Delivery Available

(313) 665-5531

fax (313) 665-0229

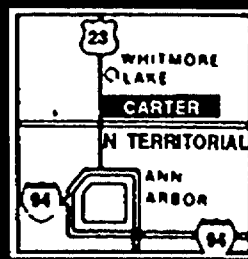



**TOMMY'S  
TIRE & AUTO REPAIR**  
Formerly Metro 25 Tire  
COMPLETE AUTOMOTIVE REPAIR

January 1996  
A leading consumer  
magazine tests 10  
name brand light  
truck radials and  
declares  
**DUNLOP RADIAL  
ROVER #1**

**For Only 4 TIRES  
\$129**

Do you need a set of  
tires, but don't have  
the time?  
Do you need service  
work, but always in a  
hurry?  
We'll arrange to have your car picked up, then  
worked on, and returned to you in order to meet  
your busy schedule.

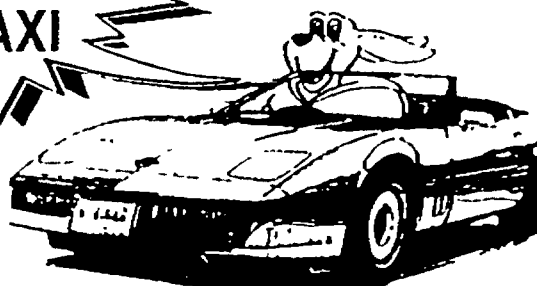

- 12 HOT SIZES**
- P155/80R13
  - P165/80R13
  - P175/80R13
  - P185/75R14
  - P185/80R13
  - P195/75R14
  - P205/75R14
  - P205/75R15
  - P215/75R14
  - P215/75R15
  - P225/75R15
  - P235/75R15

**COUPON**  
ALL THREE ONE LOW PRICE!  
**WINTER  
SERVICE PACKAGE!**  
1. COMPLETE VEHICLE  
INSPECTION  
In-depth visual analysis of major systems:  
• Tires • Suspension • Brakes • Cooling •  
Starting • More  
2. OIL CHANGE & FILTER  
3. FOUR-TIRE ROTATION  
**\$24.99**  
\*plus  
EDF Most Vehicles.  
Reg. \$38.99

**COUPON**  
**Oil Lube & Filter**  
• New Oil Filter  
• Lubricate Most Cars  
• up to 5 qts. 10w30  
present coupon at write up  
**\$14.99** plus  
EDF

**FLUSH & FILL**  
**\$29.90**  
**POWER FLUSH**  
**\$49.90**  
• Plus  
Recycling Fee

**\$29.90**  
STD.  
ALIGNMENT  
Most Cars  
Thrust  
Alignment  
**\$39.90**  
4W  
Alignment  
**\$49.90**

**BATTERIES**  
from **\$24.90**  
• With Exchange  
• Installation Available

**BRAKE SPECIAL**  
from **\$39.90**  
**BENDIX**  
has lifetime warranty.  
• Most Cars & Trucks  
• Semi Metallic Pads  
and Labor Extra

**SHOCKS & STRUTS**  
**MONROE**  
• Lifetime Warranty  
• Free Inspection  
7 Days a Week  
from **\$39.90**  
Installation  
Available

**TUNE-UP**  
4 cyl. **\$39.90**  
6 cyl. **\$49.90**  
8 cyl. **\$59.90**  
• Includes plugs  
• Timing  
• Adjust Idle  
• Most Cars, Vans  
Slightly Higher

**20% OFF**  
Mufflers,  
Belts or  
Hoses

STEEL RADIALS	PREMIUM STEEL RADIALS	TRUCK-VAN & R.V.	HIGH PERFORMANCE	MICHELIN
<b>\$17.99</b> 145SR13	<b>\$28.99</b> 165/80R13	<b>\$37.99</b> 235/75R15	<b>\$31.99</b> 175/70R13	<b>\$60.99</b> 205/65R15
175/70R13.....\$29.99 185/70R13.....\$31.99 185/70R14.....\$32.99 195/70R14.....\$34.99 195/75R14.....\$29.99 205/75R14.....\$31.99 215/75R15.....\$34.99 235/75R15.....\$36.99	175/70R13.....\$31.99 175/70R14.....\$34.99 185/70R14.....\$39.99 205/70R14.....\$40.99 215/70R14.....\$41.99 215/70R15.....\$44.99	31-10.50R15.....\$75.99 30-9.50R15.....\$69.99 235/85R16.....\$75.99 245/75R16.....\$75.99 27X850R14.....\$67.99 225/85R16.....\$70.99	185/70R14.....\$38.99 195/60R15.....\$44.99 195/70R14.....\$44.99 205/65R15.....\$49.99 215/65R15.....\$50.99 255/70R15.....\$49.99	215/70R15.....\$69.99 215/75R14.....\$69.99 225/60R16.....\$75.99 205/70R15.....\$84.99 235/75R15.....\$74.99

**CUSTOM WHEELS**  
**\$21.99** & Up

**Firestone FR360\***  
or  
60,000 mile Premium Golden Bears

**4 for \$99.99** P155/80R13

**ANY 13" TIRES** **4 for \$139.99**  
P145/80R13 P175/80R13 P175/70R13  
P165/80R13 P185/80R13 P185/70R13

**ANY 14" TIRES** **4 for \$169.99**  
P175/70R14 P205/75R14 P185/70R14  
P185/75R14 P205/70R14 P195/70R14  
P195/75R14 P215/70R14 P215/75R14

**ANY 15" TIRES** **4 for \$199.99**  
P205/75R15 P225/75R15 P205/70R15  
P215/75R15 P235/75R15 P215/70R15  
P195/60R15 P205/60R15 P225/70R15

**DUNLOP D60**  
**\$37.99** P175/70R13

- 175/65HR14.....49.99
- 185/60HR14.....52.99
- 195/60HR15.....59.99
- 195/70HR14.....53.99
- 205/55HR16.....89.99
- 205/60HR15.....62.99
- 205/65HR15.....65.99
- 225/60HR16.....85.99

**DUNLOP SP40**  
**\$35.99** P165/80R13

- 185/70R14.....46.99
- 185/75R14.....40.99
- 195/70R14.....45.99
- 195/75R14.....44.99
- 205/65R15.....49.99
- 205/70R15.....56.99
- 205/75R14.....48.99
- 235/75R15.....54.99

**DUNLOP SP20**  
**\$48.99** P195/65R15

- 175/70R13.....34.99
- 185/70R14.....39.99
- 175/65R14.....44.99
- 185/65R14.....45.99
- 195/65R14.....47.99
- 195/70R14.....44.99

**Firestone**  
**\$54.99** P195/60R15

- 185/65R14.....55.99
- 225/70R14.....65.99
- 215/70R15.....50.99
- 225/60HR15.....59.99
- 195/60R15.....61.99
- 265/75R15.....89.99

**GENERAL**  
**\$23.99** P155/80R13

- 185/70R14.....44.99
- 205/65R15.....49.99
- 235/75R15.....51.99
- 205/70R15.....53.99
- 225/60R16.....65.99
- 215/75R14.....48.99

**UNIROYAL**  
**\$30.99** P165/80R13

- 145/80R13.....26.99
- 205/75R15.....46.99
- 215/75R15.....57.99
- 205/70R15.....58.99
- 185/65R14.....47.99
- 235/75R15.....56.99

**GOODYEAR**  
**ALL GOOD YEARS ON SALE**

- 175/65R14.....62.99
- 205/70R15.....81.99
- 235/75R15.....85.99
- 225/70R16.....89.99
- 225/60R16.....103.99
- 205/55R16.....104.99

**NO PAYMENTS FOR 90 DAYS!**  
**NO INTEREST NO ANNUAL FEE**

\*Not available in all sizes. Items not exactly as pictured.  
**ROAD SERVICE**

**TOMMY'S TIRE**  
Formerly Metro 25 Tire  
43111 Grand River • Novi, Mich. 48375  
(1/4 Mile East of Novi Rd.) • South side of Grand River  
**(810) 348-2080**

**OPEN EVERY DAY**  
SUNDAY: 10:00 to 4:00  
MON.-FRI. 8:00 to 7:00  
SATURDAY 8:00 to 6:00  
Just Say Charge It!

**R**elax in the warm comfort of our dining rooms and enjoy some of Chef Rocky's latest creations such as:

- \* **GRILLED VENISON LONDON BROIL** - in a natural sauce served with scalloped potatoes and fresh vegetables.
- \* **BRAISED SHORT RIBS OF BEEF** - with rich brown sauce, scalloped potatoes and fresh vegetables.
- \* **PAELLA** - a Spanish entree combining saffron seasoned rice cooked with fresh seafood, chorizo sausage, chicken and assorted vegetables.
- \* **VENISON STEW** - braised venison in a rich wine sauce with dried fruit, served over rice.
- \* **CASSOULET OF DUCK** - confit of duck baked with white beans, vegetables and mushrooms.
- \* **GNOCCHI AND FLORIDA ROCK SHRIMP** - Portabella mushrooms, fresh basil and Gorgonzola tomato sauce.
- \* **GRILLED CENTER CUT PORKCHOPS** - lamac in garlic, homemade apple salad and scalloped potatoes.

After dinner settle in next to the fire and enjoy the comfort of the "Winter Warmer" cocktail and our **PEPPERMINT PARTY** cake. For more information call Peppy at 810-227-7900. **CAFE ROCKY** is open 7 days a week, 11:00 am - 10:00 pm. For more information call Peppy at 810-227-7900.

Best of all, you can enjoy the **MEALS OF THE MONTH** at a special price. Call Peppy at 810-227-7900 for more information. **"Winter Delights"** is available from 11:00 am - 10:00 pm. Sign up for our **WINTER DELIGHTS** conference. For more information call Peppy at 810-227-7900. *It's a great way to warm up your winter!*



**NORTHVILLE**

**BRIGHTON**



**\$5.00 Off Brunch**

**P** \$5.00 OFF *any entree*

**Rocky's**  
OF BRIGHTON

5311 Brighton Rd.  
Brighton, MI

810-227-7900

**\$5.00 Off Lunch**

**P** \$5.00 OFF *any entree*

**Rocky's**  
OF BRIGHTON

5311 Brighton Rd.  
Brighton, MI

810-227-7900

**\$8.00 Off Dinner**

**P** \$8.00 OFF *any entree*

**Rocky's**  
OF BRIGHTON

5311 Brighton Rd.  
Brighton, MI

810-227-7900

**\$5.00 Off Lunch**

**P** \$5.00 OFF *any entree*

**Rocky's**  
OF NORTHVILLE

11122 W. SIXES MILE ROAD  
NORTHVILLE, MI

810-349-4434

**\$8.00 Off Dinner**

**P** \$8.00 OFF *any entree*

**Rocky's**  
OF NORTHVILLE

11122 W. SIXES MILE ROAD  
NORTHVILLE, MI

810-349-4434

WARM UP YOUR WINTER WITH CHEF ROCKY'S



**R**ocky's offers a variety of seasonal menus for your winter dining.

- GRILLED VENISON LONDON BROIL  
SERVED WITH POTATOES
- BRAISED SHORT RIBS OF BEEF  
WITH MUSHROOMS
- PASTA -  
WITH SAUCE
- VENISON STEW
- CASSOULET OF DUCK
- GNOCCHI AND  
FLORIDA ROCK SHRIMP
- GRILLED CENTER  
CUT PORKCHOIS

- WHITE WINE
- PEPPERMINT PARTY
- CALL  
ROCKY

Winter Delights

It's a great way to warm up your winter

**Rocky's**



**\$5.00 Off Brunch**

**P** \$5.00 OFF

*Rocky's*

5311 Brighton Rd.  
Brighton, MI  
810-227-7900

**\$5.00 Off Lunch**

**P** \$5.00 OFF

*Rocky's*

5311 Brighton Rd.  
Brighton, MI  
810-227-7900

**\$8.00 Off Dinner**

**P** \$8.00 OFF

*Rocky's*

5311 Brighton Rd.  
Brighton, MI  
810-227-7900

**\$5.00 Off Lunch**

**P** \$5.00 OFF

*Rocky's*  
OF NORTHVILLE

11122 W. SIXTH MILE ROAD  
NORTHVILLE, MI  
810-349-4434

**\$8.00 Off Dinner**

**P** \$8.00 OFF

*Rocky's*  
OF NORTHVILLE

11122 W. SIXTH MILE ROAD  
NORTHVILLE, MI  
810-349-4434

# BUILDERS SQUARE

**THE LASTING PACKAGE**  
*Dutch Boy*

**Dirt Fighter Interior Latex Paint**  
Premium quality, subtle flat, washable finish. One coat coverage.

WAS: 12.89

**NOW 9.99** Gal.

5 Gal. Dirt Fighter.....47.45



**UNIVERSAL FLOORING**

**12" x 12" Solid Oak Parquet Floor Tile**  
Genuine oak. No wax, pre-sealed urethane finish. Tongue and groove design. #45203

WAS: 1.39 per pc.

**NOW 1.29** per pc.

Carton of 10  
WAS 13.97.....12.90  
All items are available while quantities last. Limited to stock on hand. Sorry, no rain checks.

**SPECIAL BUY**

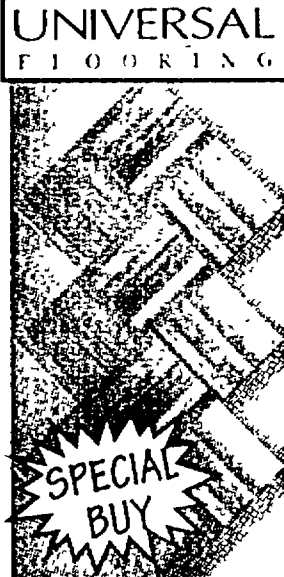

**KV Shelf-Help™ System**  
18" x 36" x 71" Heavy Duty 5 Shelf Steel Shelving  
Each shelf holds up to 250 lbs. Limited lifetime warranty. #11586

WAS: 21.99

**NOW 16.96**



ALL SIZES VINYL MINI BLINDS

**NOW 20% Off**  
our everyday low price  
WAS: \$4.28-\$16.58

# SPRUCE UP *and* SAVE Square by Square!

Prices guaranteed Wed., January 22 thru Tues., January 28, 1997

**SYLVANIA**  
75 Watt Indoor Reflector Flood Bulbs  
#15134/15133

WAS: 3.99

**NOW 2.77**



**4' x 8' x 3/4" BC Sanded Plywood**

**NOW 20% OFF**  
OUR EVERYDAY LOW PRICE

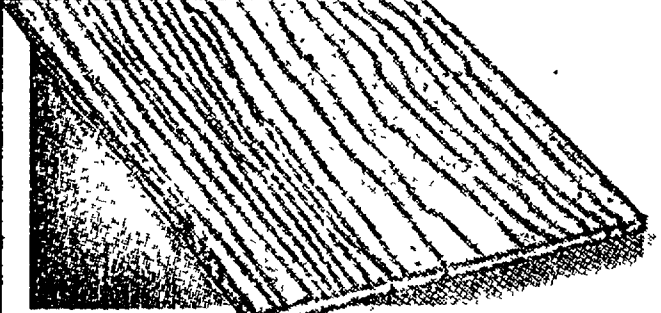

**Special**

**\$25 OFF**

OUR EVERYDAY LOW PRICE

**ANY IN-STOCK LAWNMOWER**

VALUED AT \$150 OR MORE

**LIMIT ONE PER CUSTOMER**

All items are available while quantities last. Limited to stock on hand. Sorry, no rain checks.

AMERICAN MADE  
YARD MACHINES  
BRIGGS & STRATTON

**\$100 MERCHANDISE VOUCHER OFFER**

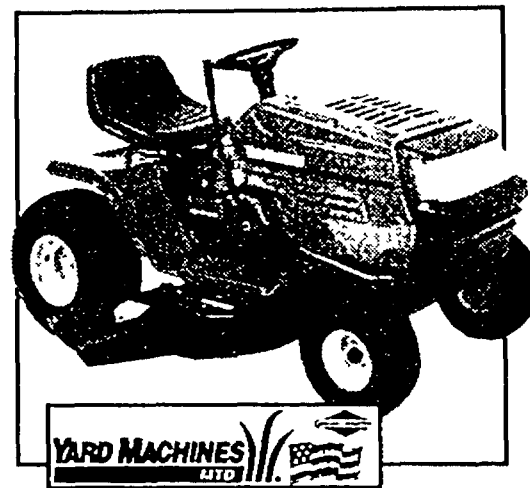

OUR EVERYDAY LOW PRICE **1299<sup>97</sup>**

MAIL IN MERCHANDISE VOUCHER **100<sup>00</sup>**

FINAL VALUE AFTER MAIL IN VOUCHER **1199<sup>97</sup>**

**18.5 HP LAWN TRACTOR**

- Briggs & Stratton twin cylinder I/C engine.
- 7 Speed shift-on-the-go transmission.
- 46" Triple blade mowing deck. SKU# 1137751 #13AS675H302

YOUR NAME \_\_\_\_\_

ADDRESS \_\_\_\_\_

CITY, STATE, ZIP \_\_\_\_\_

Mail this coupon and your original cash register receipt to:  
**BUILDERS SQUARE, INC., 1700-A RANCH ROAD 12 - SUITE 301, SAN MARCOS, TX, 78666.**

Builders Square is not responsible for lost, incomplete, or misdirected mail. Merchandise voucher is not redeemable for cash, each customer will receive a \$100 Builders Square merchandise voucher redeemable at any Builders Square location. Voucher is valid for purchases made between 1/22/97 and 01/28/97. All coupons must be postmarked no later than 02/28/97. Allow 3 - 5 weeks delivery. Merchandise voucher is valid for 90 days.

**BIG pre-season savings!**

**6 MONTHS SAME AS CASH**

\*NO PAYMENTS NO INTEREST FOR 6 MONTHS ON MOWERS AND TRACTORS OVER \$249! Minimum purchase required. Same as cash - If balance is paid within the 6 month period, accrued finance charges will be waived; if not, finance charges will be assessed from the date of purchase. With qualified credit when you use your Builders Square or Square Plus credit card. The rate may vary. As of 4/1/96, 20.75% APR on Builders Square credit card. The rate may vary. 12.5% APR on Square Plus credit card. \$ .50 Minimum finance charge. Not valid with any other offer. Offer expires 1/28/97.

**Homelite<sup>®</sup>**  
**WEED EATER<sup>®</sup>**  
**RYOBI.**  
**Poulan<sup>®</sup>**

**\$10 OFF**

OUR EVERYDAY LOW PRICE

**ALL GAS STRING TRIMMERS**

All items are available while quantities last. Limited to stock on hand. Sorry, no rain checks.

**Homelite<sup>®</sup>**  
**McCULLOCH<sup>®</sup>**  
**Poulan<sup>®</sup>**

**\$15 OFF**

OUR EVERYDAY LOW PRICE

**ALL GAS CHAINSAWS**

All items are available while quantities last. Limited to stock on hand. Sorry, no rain checks.

**10% off**

OUR EVERYDAY LOW PRICE

NOT ALL ITEMS AVAILABLE IN ALL STORES

**All Tractor Attachments**

CHOOSE FROM ASSORTED TRACTOR CARTS, GRASS BAGGERS, TOW SPREADERS, SWEEPERS, DETHATCHERS & AERATORS.

All items are available while quantities last. Limited to stock on hand. Sorry, no rain checks.

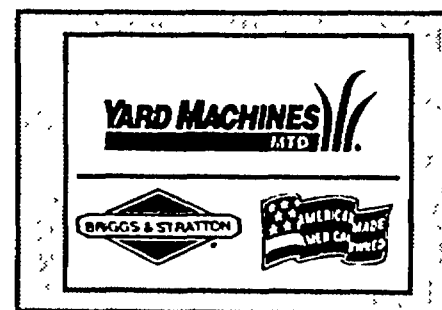

**\$20 OFF**

OUR EVERYDAY LOW PRICE

**ALL MTD GARDEN TILLER FRONT OR REAR TINE**

All items are available while quantities last. Limited to stock on hand. Sorry, no rain checks.

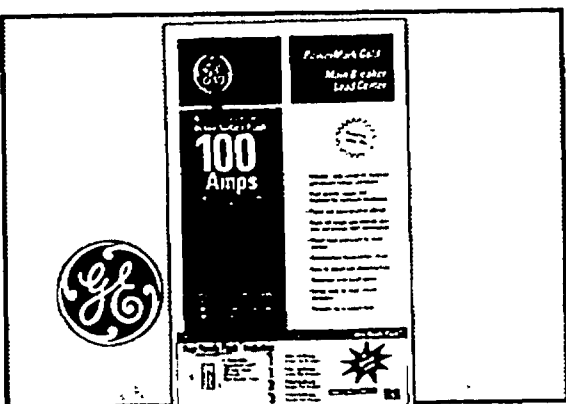

**MAIN BREAKER LOADCENTER VALUE PACK**  
 Contains: • 1-TM2010CCP 100 AMP, 20 circuit, Main Breaker Panel • 6-15 AMP • 6-20 AMP Single Pole Breaker • 1-30 AMP, 2" Double Pole Breaker • 1-50 AMP, 2" Double Pole Breaker  
**79<sup>52</sup>**  
 #TM2010CKIT4 If Purchased separately..... **128.52**

**200AMP** #TM2020CKIT2..... **132** If Purchased separately..... **177.71**

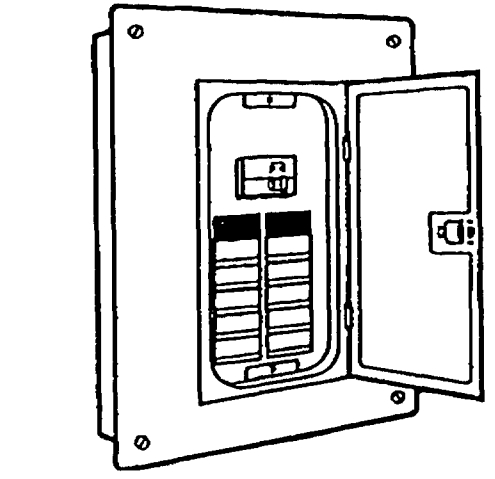

**LOAD CENTER WITH 100 AMP MAIN BREAKER**  
 • 4-20 AMP Breakers

**56<sup>98</sup>** #HOMVP10 If Purchased separately..... **80.64**  
**200AMP** #HOMVP9..... **125.98** If Purchased separately..... **195.34**

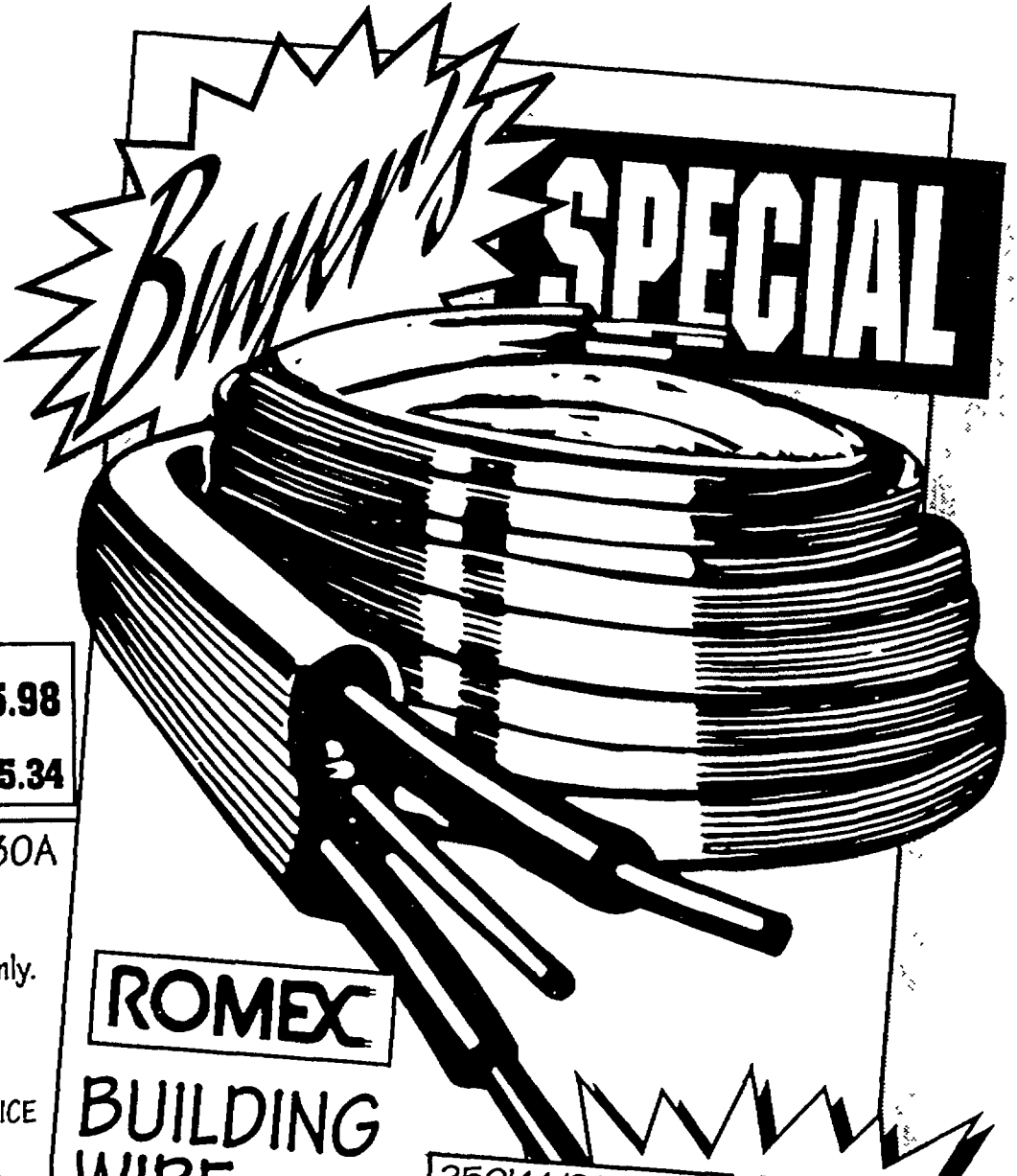

**ROMEX BUILDING WIRE**  
 For both exposed and concealed interior wiring.

250' 14/2 NW WIG  
**NOW ONLY \$17**  
 WAS 18.26

250' 12/2 NW WIG  
**NOW ONLY 24<sup>75</sup>**  
 WAS \$28

**SQUARE D** 30A 2 CIR. INDOOR LUG LOADCENTER  
 2 full size circuits 30A lug. Surface cover indoor. #Q02L30SCP  
**8<sup>88</sup>**

**SQUARE D** Q0 15A, 20A, 30A SINGLE POLE BREAKER  
 Q0 loadcenters only.  
**5<sup>98</sup>** YOUR CHOICE  
 15A, 20A, 30A SINGLE POLE BREAKER  
 Homeline loadcenters only.  
 #HOM115, #HOM120, #HOM130  
**3<sup>48</sup>** YOUR CHOICE

**GREAT STUFF FOAM SEALANT**  
 #M51212-01  
**3<sup>63</sup>** 12 OZ.  
 20 OZ. #M52412-01..... **7.99**

**Money-saving prices on electrical projects!**

**Carlson** SINGLE GANG BOX WITH CAPTIVE NAILS  
 2-7/8"D X 2-1/4"W X 3-3/4"L. 18 cubic inches. #B118A-UPC  
**19<sup>c</sup>**  
 2-1/2"D X 2-1/4"W X 3-3/4"L. 16 cubic inches. #B116A-UPC  
**18<sup>c</sup>**

**RACO** HANDY BOX 1-7/8"D X 2-1/8"W X 4"L. Welded construction with 1/2" knockouts. U.L. Listed. #8660  
**55<sup>c</sup>**  
**HANDY BOX WITH BRACKET** #8662  
**85<sup>c</sup>**

**RACO** 4" OCTAGON BOX 1/2" knockouts. U.L. Listed. #8125  
**62<sup>c</sup>**  
 4" OCTAGON BOX 1/2" & 3/4" knockouts. #127  
**72<sup>c</sup>**  
 WITH CLAMPS #8146..... **1.12**

**SQUARE D** T-STRIPPER  
 Stripper for 10-18 AWG solid wire or 12-26 AWG stranded wire.  
 #45-120, #45-121  
**8<sup>98</sup>** YOUR CHOICE

**SYLVANIA** DELUXE BULBS Cool white. F40 #24474-F40CWXCYP  
**12<sup>75</sup>** 10 PACK

**LEVITON** GROUNDING QUIET SWITCH Choose from ivory, brown or white.  
**44<sup>c</sup>**  
**DUPLEX OUTLET** Choose from ivory, brown or white.  
**36<sup>c</sup>**

**LEVITON** KEYLESS PORCELAIN LAMP HOLDERS Fits either 3-1/4" or 4" standard outlet boxes.  
**1<sup>25</sup>** #000-9875 W/PULL CHAIN  
**1<sup>96</sup>** #011-29816-C

**GB** 4 WAY TESTER #GET 203  
**4<sup>25</sup>**  
**RECEPTACLE TESTER** Detects faulty wiring in ground receptacles. #GRT-500  
**4<sup>75</sup>**



**58-LB READY MIX ALL PURPOSE JOINT COMPOUND**

Repairs cracks and holes in plaster, wall board, ceilings and walls. Finish gypsum wallboard joints.

NOW ONLY **6.48**

WAS 7.98

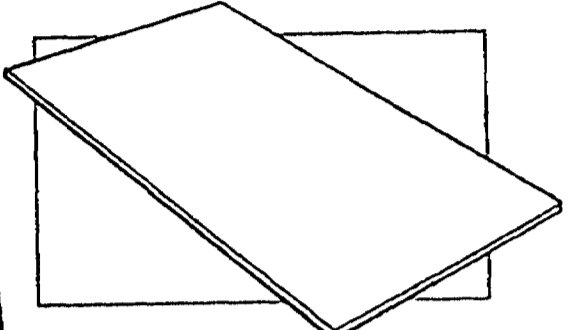
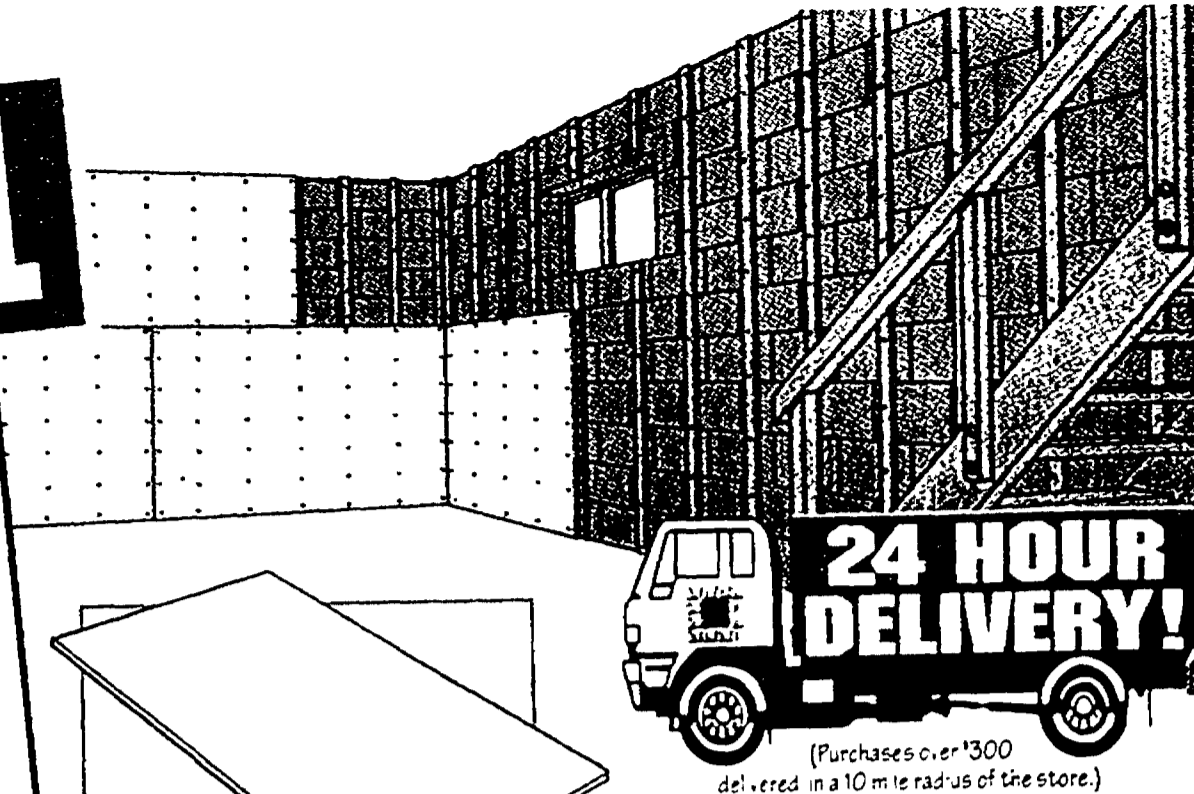

**4'x8'-3/8" REGULAR GYPSUM BOARD**  
Tapered edges for easy finishing. For new construction. Perfect for remodeling.

**4.74**

4'x8'-1/2" WATER RESISTANT.....**7.58**

4'x8'-5/8" FIRECODE.....**6.58**

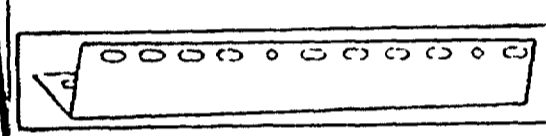

**DRYWALL CORNER BEAD**  
1 1/2"x1 1/2"x8'  
Galvanized. **1.05**



**3 1/2"-8' 25 GAUGE METAL SCREW STUD** **1.46**

10' DRYWALL CORNERBEAD...**1.39**

3 1/2"-10' STUD.....**1.84**

3 1/2"-10' TRACK.....**1.88**

**Quality materials at budget prices every day!**

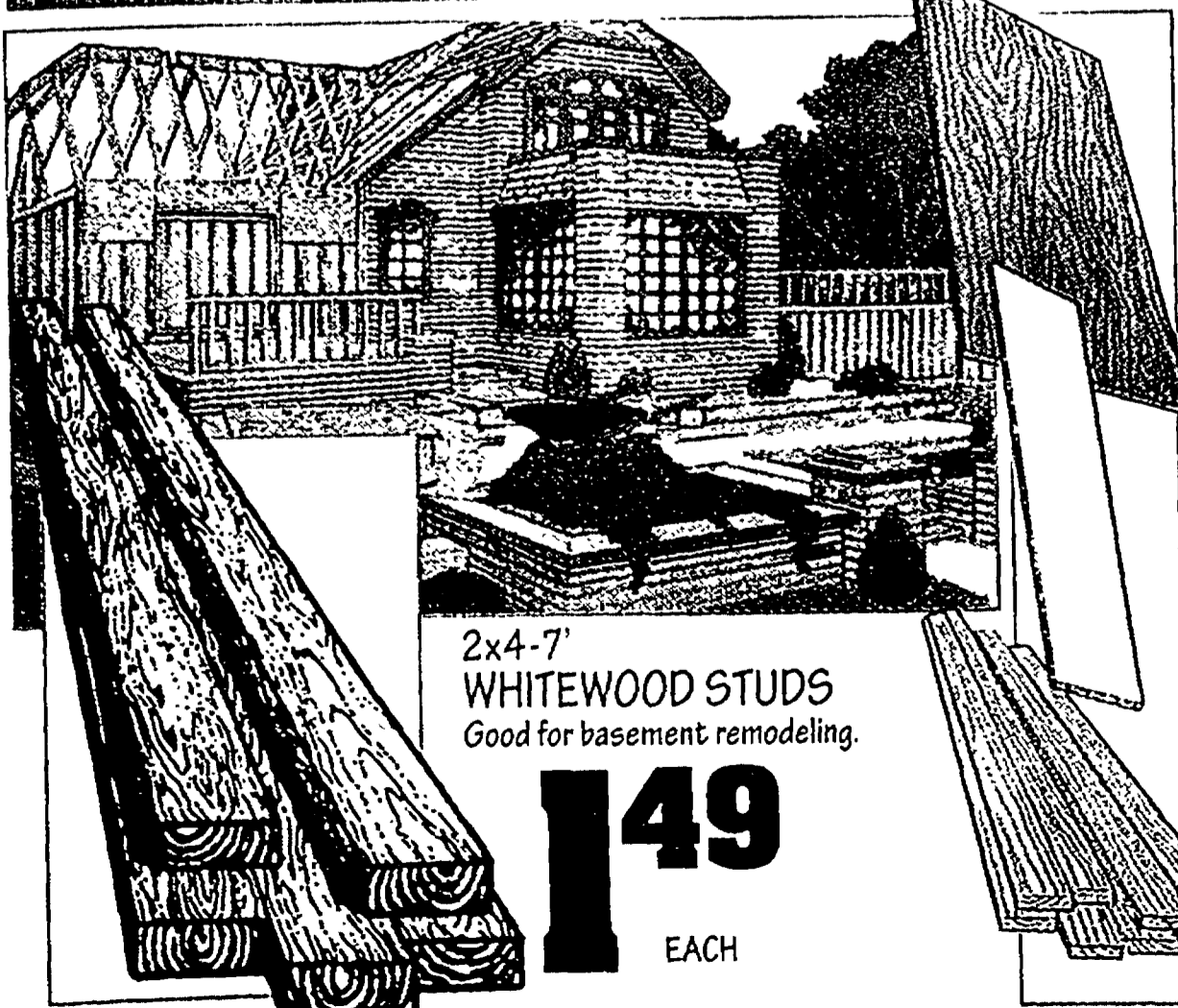

**2x4-7' WHITEWOOD STUDS**  
Good for basement remodeling.

**1.49** EACH

**4x8-1/2" BC SANDED PLYWOOD**

**12.49**

4x8-1/2" BC .....**9.16**

**2x8-1 1/2" WALLMATE**

**7.45**

**WHITEWOOD BOARDS**

SIZE	6'	8'	10'	12'
1x4	1.93	2.50	3.19	3.98
1x6	2.96	3.64	4.68	5.98
1x8	3.69	4.79	6.98	8.68

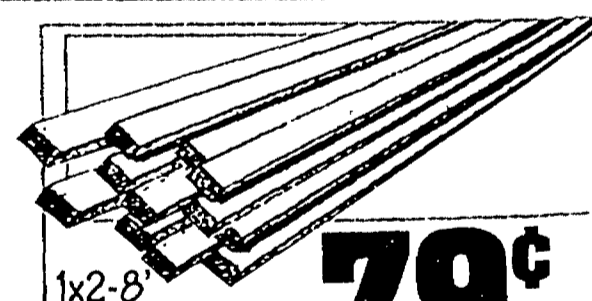

**1x2-8' WHITEWOOD FURRING STRIPS** **79¢** EACH

A basic whitewood for paneling applications and construction projects.  
1x3-8'.....**1.35** 2x2-8'.....**1.39**

**ATTENTION CUSTOMERS:**  
TO CORRESPOND WITH THE LUMBER COMMODITY MARKET OUR PRICES ARE ADJUSTED DAILY. PRICES IN THIS AD MAY VARY FROM ACTUAL PRICES AT TIME OF PURCHASE.



8 1/4" X 16" ATTIC & CRAWL SPACE INSULATION  
R-25 PINK PLUS MIRAFLEX  
Virtually itch-free. New compact roll. Easier to handle and install. 8.75 thick/16" wide 33.33 sq ft. No vapor barrier/perforated poly wrap. #A43

**13<sup>88</sup>**

8 1/4" X 24"  
20.79



6 1/4" X 15" MULTI-PURPOSE INSULATION R-19  
KRAFT FACED FIBERGLASS  
48.95 sq. ft. coverage per roll. Kraft faced vapor barrier prevents moisture build-up. For exterior walls, floors, crawl spaces & attics.

**11<sup>27</sup>**

3 1/2" X 15" 77.5 SQ.FT. WALL INSULATION R-13 PINK PLUS  
Comfortable to touch. Less itch and irritation. Easy to handle and install. #C91

**16<sup>89</sup>**

Savings vary. Find out why on the seller's fact sheet on R-values. Higher R-values mean greater insulating power.

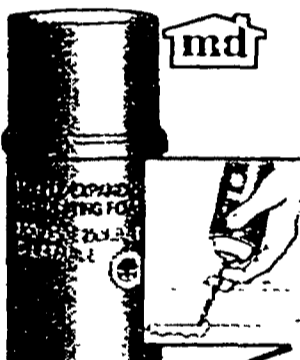
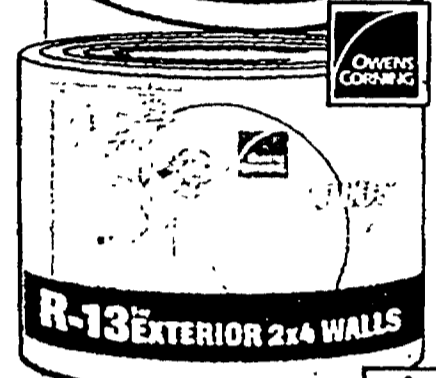

TRIPLE-EXPANDING INSULATING FOAM  
Fill holes and stops drafts. Used for insulating around electrical outlets, around window, doors, and air conditioners. #17442

**3<sup>98</sup>**

12 oz.

Savings vary. Find out why on the seller's fact sheet on R-values. Higher R-values mean greater insulating power.

**SPECIAL**

OWENS CORNING

3 1/2" X 15" WALL INSULATION R-13 KRAFT FACED MINI ROLL  
40 sq. ft. coverage per roll. Kraft faces vapor barrier prevents moisture build-up. Do-it-yourself installation is quick and easy. #K95

**R-13 For EXT**

NOW ONLY **6<sup>99</sup>** WAS 8.99

**INSTALLS**

**We install drop ceilings.**

job code 0467

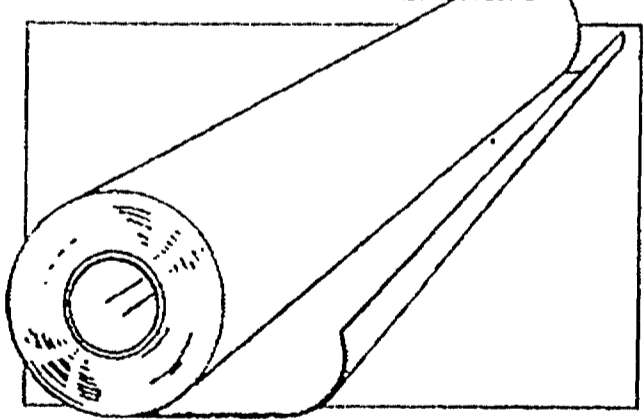

**POLYETHYLENE SHEETING**

10x100x.006 CLEAR	25.92
10x100x.006 BLACK	25.92
20x100x.006 CLEAR	49.99
20x100x.006 BLACK	49.99
10x100x.002 CLEAR	11.99
10x100x.002 BLACK	11.99

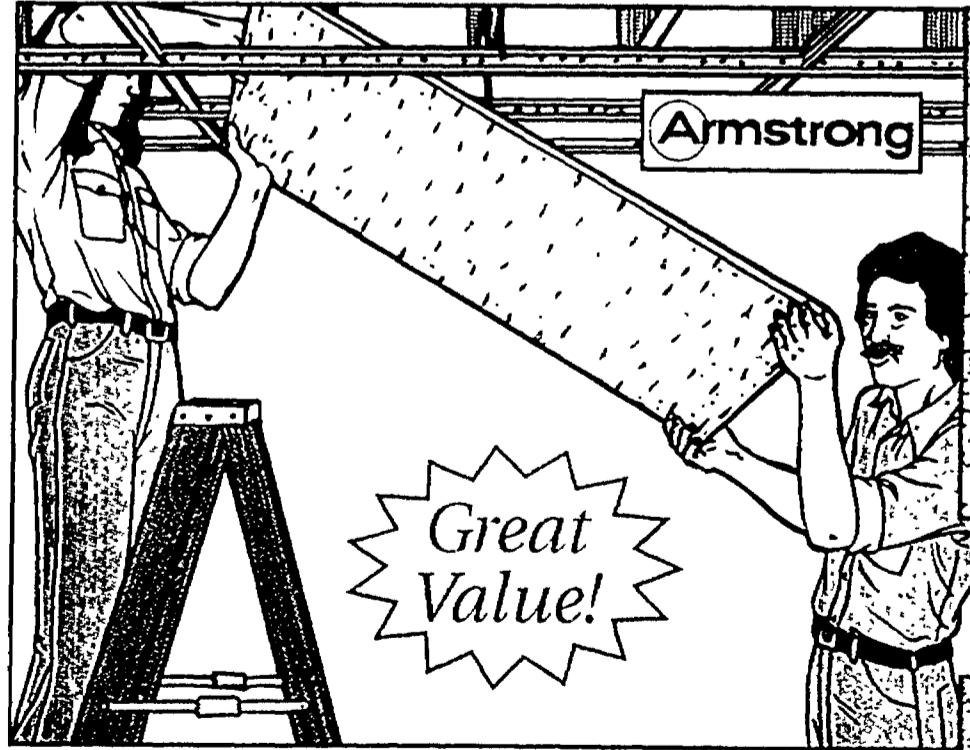

**Great Value!**

DESCRIPTION	PRICE	DESCRIPTION	PRICE
2x4 LAY-IN BALTIC	18.72	2x4 RANDOM TEX	28.90
2x4 FIBERGLASS	58.88	2x2 BRIGHTON	39.52

Armstrong

2'x4' TEXTURED CEILING PANEL  
Fire retardant 5/8" thick. Washable, textured surface. #942

**22<sup>80</sup>**

Armstrong

12'x12' BALTIC CEILING TILE  
Washable. Textured. 40sq. ft. per carton. #1132

**15<sup>60</sup>**

\* #TACLA001191C, #62623, #PC81017705, #105954, #2102085035, #TACLB002928C, #210208503, #TACLA000876, #MN0006039, #0003812M4, ICT#1481, 3208, 2888, 2728



# SPECIAL

## PRO-TECH.

### 10"/15 AMP COMPOUND MITER SAW

5000 rpm motor  
includes  
dust bag, workpiece clamp  
extension arm and angle  
scale. #5005

NOW ONLY

# 179<sup>96</sup>

WAS 199.96

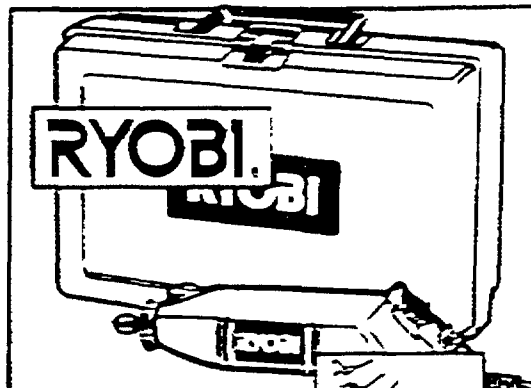

RYOBI  
10-PIECE  
MULTI-TOOL KIT  
50% more power than competitive  
brands. Variable speed control. 1/2" driver.

# \$52

22 ACCESSORIES  
AND STORAGE  
CASE



Makita  
1.6 AMP  
FINISHING SANDER  
WITH DUST BAG  
Uses 1/4 sheet sandpaper. #504552

# \$46

COMPACT AND  
LIGHTWEIGHT

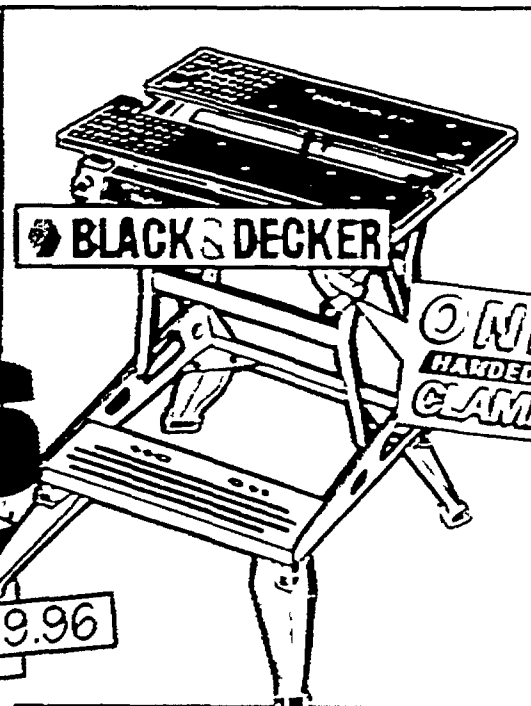

BLACK & DECKER  
WORKMATE 225  
PROJECT CENTER

Advanced one-handed clamp™ system  
with exclusive clutch design for easy  
clamping. Advanced clutch design allows  
for fine-tuning. Folds for easy storage.  
Steel construction holds up to  
450 lbs. Dual height for use as a  
workbench, bench tool stand, vise  
or sawhorse. #WV225

ONE  
HANDED  
CLAMP™

# 59<sup>96</sup>

## Money savers for do-it-yourselfers.



RYOBI  
DETAIL  
BISCUIT JOINER  
Revolutionary design utilizes three ultra-small  
7-scut sizes. Reversible fence  
for 90° and 45°. 10-foot  
rubber cord. #50350

# 69<sup>97</sup>



DEWALT  
9.6V-3/8"  
CORDLESS  
VSR DRILL KIT  
Dual range 0-400  
0-100 RPM. Fan cooled  
motor with electronic  
brake. Includes 1/2" tool  
charger, 2 batteries,  
double-ended screwdriver  
bit, and carrying case.  
#DWE521-1

# 124<sup>98</sup>

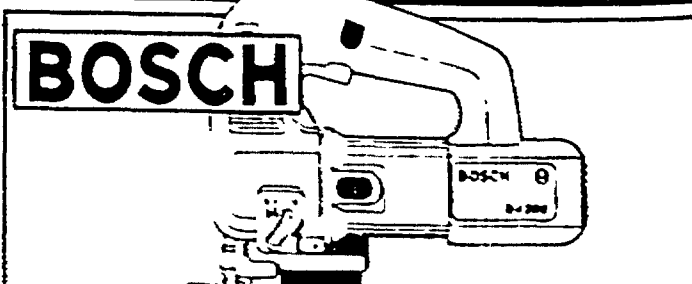

BOSCH  
VS TOP-HANDLE  
ORBITAL JIG SAW  
4.8 AMP variable speed 500-3,100 SPM. 1"  
stroke length. 4-position  
orbit action. Ball & roller  
bearing construction.  
#5400

# 159<sup>96</sup>

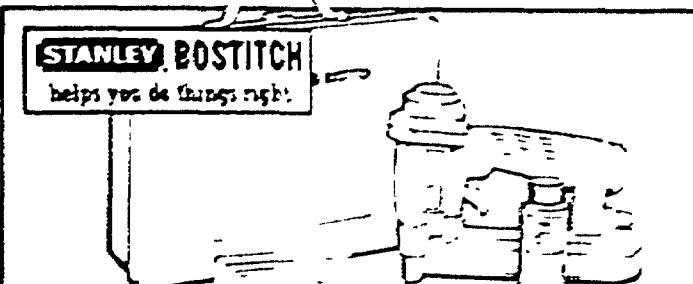

STANLEY BOSTITCH  
helps you do things right.  
PNEUMATIC 1-3/8"  
BRAD TACKER KIT  
Uses: paneling, cabinet work, interior trim, molding,  
staircases, crafts.  
Features: powerful motor  
#57354

# 178<sup>99</sup>



shop-vac  
4 HP-20 GALLON  
WET/DRY VAC  
Powerful motor for the  
toughest mess-wet or  
dry. Rugged tanks made  
of rust-proof, dent  
resistant plastic.  
Automatic float shut off  
prevents wet pick-up  
overflow. #570-24

# \$99

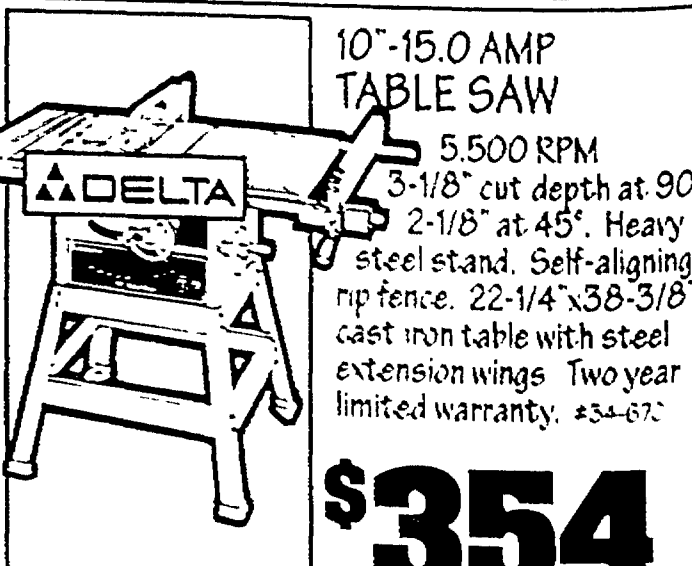

DELTA  
10"-15.0 AMP  
TABLE SAW  
5,500 RPM  
3-1/8" cut depth at 90°  
2-1/8" at 45°. Heavy  
steel stand. Self-aligning  
rip fence. 22-1/4"x38-3/8"  
cast iron table with steel  
extension wings. Two year  
limited warranty. #34-670

# \$354

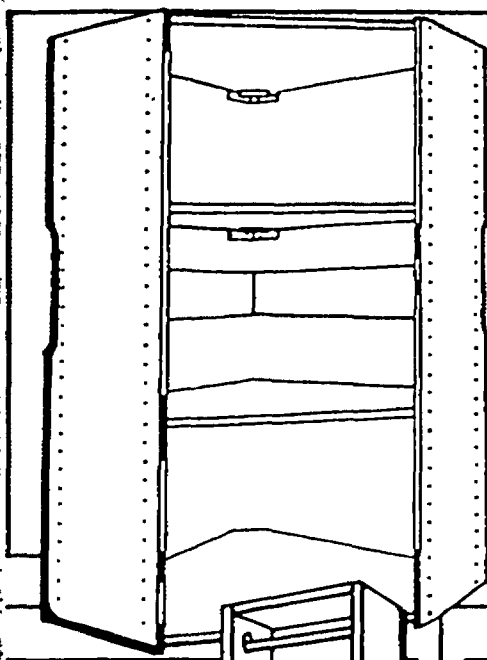

**SYSTEM WORKS!**

**CORNER STORAGE CABINET**  
Turns corners into useable space. The solution to walk in closet design. Hangs from existing shelf supports. #2406M6

**59<sup>99</sup>**

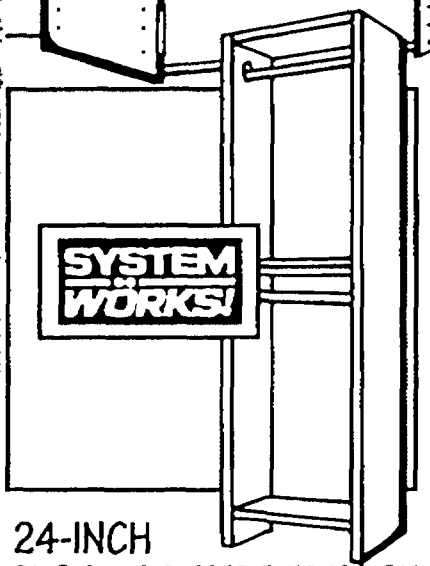

**24-INCH CLOSET STARTER PACK**  
Scratch & stain resistant melamine finish. Customize with easy fitting doors, drawers or shelves. #2400

**59<sup>99</sup>**

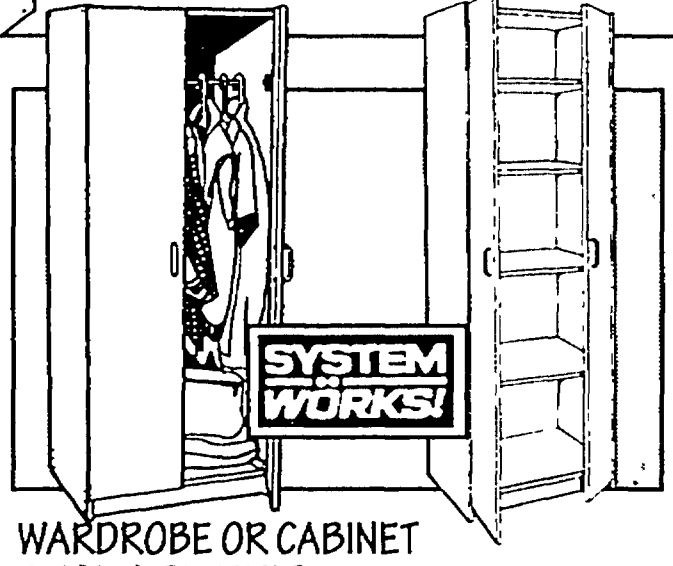

**WARDROBE OR CABINET STORAGE UNIT**  
Easy to assemble. Durable melamine laminate. Includes concealed self-closing hinges. Lifetime guarantee. #2420 51. #2430 52

**119<sup>99</sup>** EACH

**YOUR CHOICE!**

**4-FOOT SHELF BONUS PACK**  
Increased visibility of stored items. Pre-finished surface that is maintenance free. Does not warp or collect moisture, like wood. Environmentally friendly. #B5212

**LeeRowan**

**NOW ONLY 7<sup>88</sup>**

**WAS 10.97**



**LeeRowan**  
**49" - 94" CLOSET ORGANIZER**  
Fits closets up to 8-ft. wide. Includes long hang and double hang for garments. Shelves provide additional storage space. Installation hardware included. #5138

**34<sup>99</sup>**

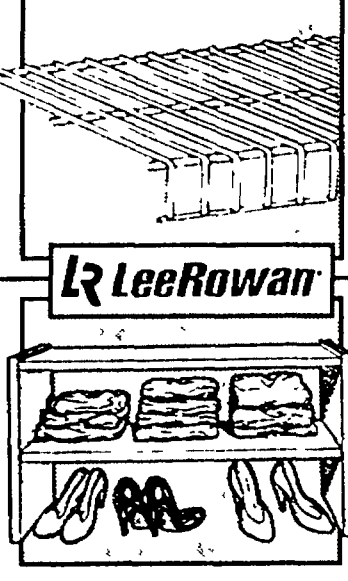

**LINEN SHELVING**  
Increased air circulation. Extends clothing's life span.

4'x12" #42124	4.59
8'x12" #41296	6.17
8'x16" #41696	9.97

**SHOE STACKER**  
Create extra space and avoid shoe pile-ups. Stackable, easy to assemble. #1000MB

**13<sup>99</sup>**

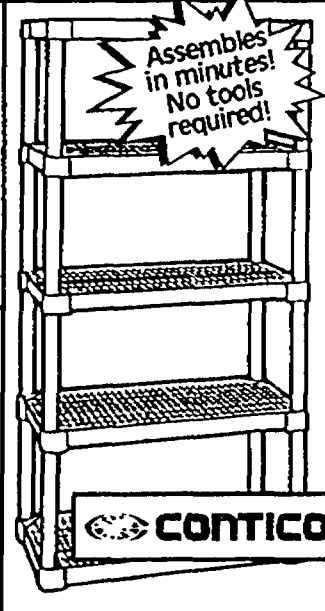

**5 SHELF VENTILATED STORAGE SHELVING**  
Very strong, yet lightweight, multi-purpose shelf that can handle a heavy load. Organize areas where additional space is needed, inside or out. Never rust or needs painting. #3618-5BK

**CONTICO \$44**

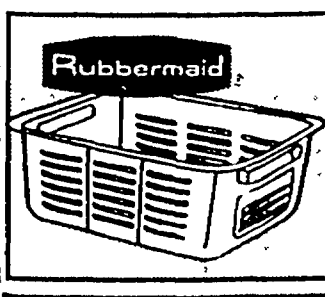

**STACKABLE BASKETS**  
In blue, white or hunter green. Not all colors available in all sizes.

Small #5225	1.99
Medium #5226	2.99
Large #5227	3.99
Extra Large #5228	4.50

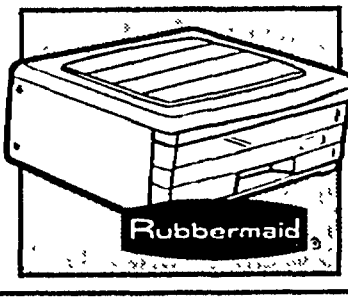

**STACKING DRAWER**  
Drawers hook together to stack in multiple combinations. See through drawers lets you see what's inside.

Small #2344	10.99
Jumbo #2345	17.77

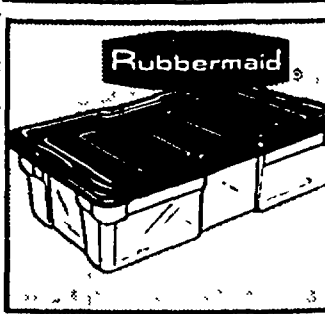

**65-QT. KEEPERS CLEAR BOX**  
#2227

**18<sup>49</sup>**

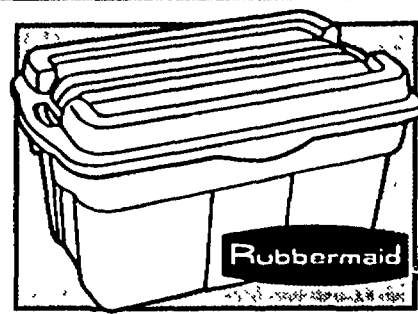

**28 GAL. HINGED ROUGHTOTE®**  
Unique snap on hinged lid. Hi-Top lid for added storage. Easy one handed access. #2461

**10<sup>99</sup>**  
40Gallon Jumbo Roughtote #2547... **17.99**

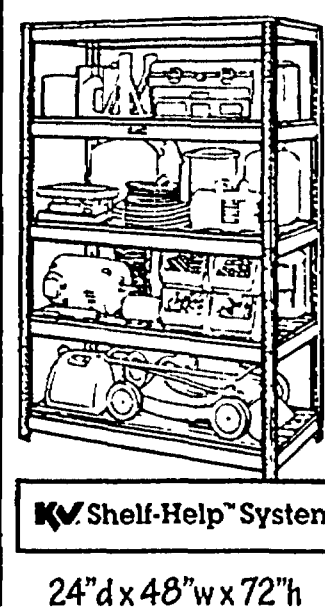

**5 SHELF STEEL MEGA-RACK™ SHELVING**  
Heavy gauge steel "L" angle post. 1/2" Thick particle board shelves. Shelves adjust every 1-1/2". Units can be joined together as a complete wall of shelving. #TMR548

**Shelf-Help™ System \$69**  
24" d x 48" w x 72" h

# Bumper SPECIAL

**Monarch**  
WINDOW FASHIONS

## PREMIUM RIBBED VINYL VERTICAL BLINDS

Deluxe valance included. Room darkening vanes. Made to European quality. Easy to maintain. Easy installation. White or alabaster. #V78B4A. #V78B4W

WHILE QUANTITIES LAST

NOW ONLY

78"x84"  
WAS 36.99

WAS 44.99  
NOW 38.88

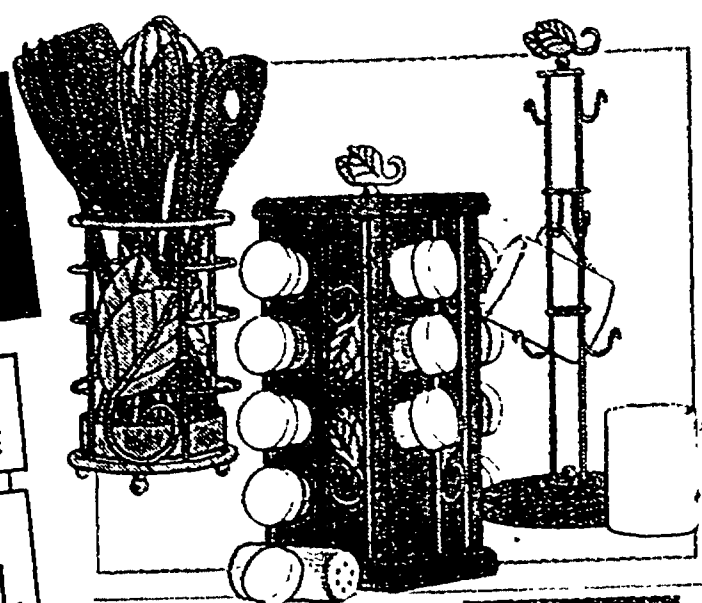

**10% OFF**  
OUR EVERYDAY LOW PRICE.

KAMENSTEIN OAK LEAF KITCHEN ACCESSORIES  
Natural oak-finished wood, brass and stylized leaves of aged verdigris.  
NOT AVAILABLE IN ALL STORES

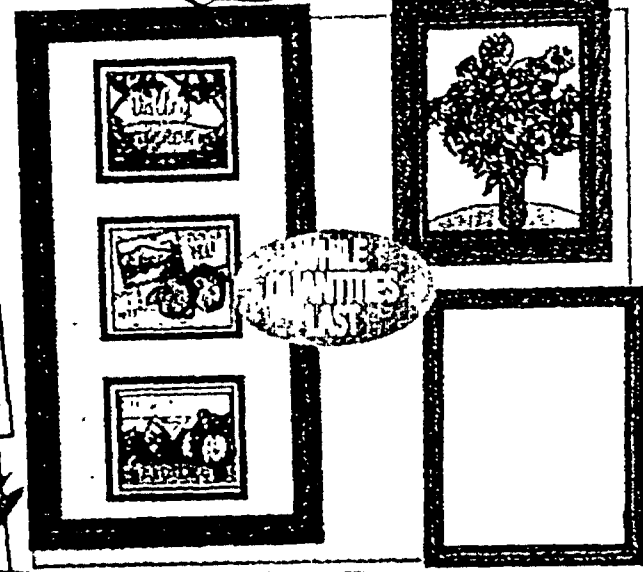

ART FAIR  
FRAMED ART AND MIRRORS  
16"x20", 11"x14", 8"x18"  
8"x10", 8"x20".  
Miscellaneous styles of art and mirrors to choose from.

**\$4.99 TO \$9.99**

VALUES UP TO \$20.00  
NOT AVAILABLE IN ALL STORES

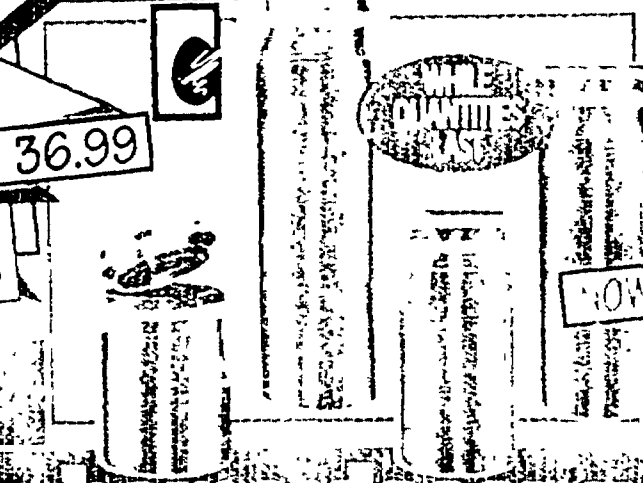

ITALGLASS DECORATIVE GLASS CANISTER SETS  
4-pc. gift boxed. Each canister has airtight seals, metal closures & virgin rubber gaskets. Green, clear, or blue.

**9.99** WAS 12.99  
YOUR CHOICE

YOUR #1 SOURCE FOR HOME DECOR VALUES.

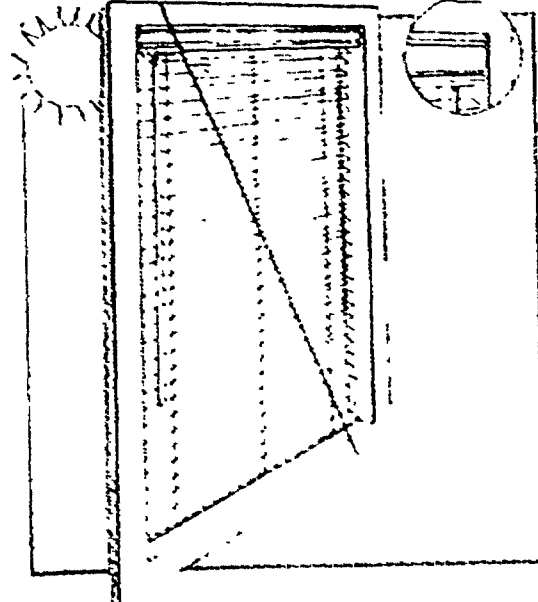

ROOM DARKENING MINI-BLINDS  
More slats for better closure. Heavy-duty headrail. Attractive 1 1/2" decorator valance. Color coordinated tilt wand. Crease-resistant/anti-dust slats. Quick release cord lock. Installation hardware included. White, alabaster, hunter.

**10% OFF**  
OUR EVERYDAY LOW PRICE  
23"x64" UP TO 48"x64"

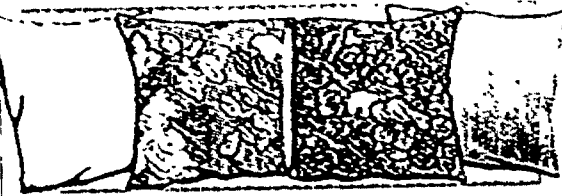

17-INCH KNIFE EDGE PILLOWS  
Available in assorted designed prints and solids. Designs may vary by store. #F40007K

**3.99** WHILE QUANTITIES LAST  
VALUES TO \$11.99



ASSORTED GREENERY ARRANGEMENTS  
Hanging baskets, table top baskets #55-500

**17.99** WHILE QUANTITIES LAST

**10% OFF**  
OUR EVERYDAY LOW PRICE.

Annual **white & bright SALE**

**LEVOLOR**  
METAL BLINDS VERTICAL BLINDS WOOD BLINDS & CELLULAR SHADES

**BALI**  
VERTICAL WOOD BLINDS & DIAMOND CELL

AVAILABLE BY **Special ORDER**

**M&B** 2" MAXI ALUMINUM AND 2" POLY BLINDS

**Graber** VERTICALS, WOOD BLINDS AND CRYSTAL PLEATS



**Glidden**

**X-PERT 10-YR. PAINT BY GLIDDEN**  
10 year warranty. One coat coverage. Easy to apply.

DESCRIPTION	1 GAL.	5 GAL.
A. INTERIOR FLAT LATEX WALL PAINT	7.97	35.90
B. INTERIOR LATEX SATIN WALL PAINT	11.21	53.75
C. INTERIOR LATEX SEMI-GLOSS WALL PAINT	11.59	53.95



THE LASTING LOOK OF  
**Dutch Boy**

**RENAISSANCE INTERIOR PAINT**  
One coat coverage saves you time. Our best interior paints.

DESCRIPTION	1 GAL.
A. INTERIOR ACRYLIC LATEX FLAT	18.99
B. INTERIOR ACRYLIC LATEX SATIN	19.99
C. INTERIOR ACRYLIC LATEX SEMI-GLOSS	21.99

**SPECIAL**

**CONFIDENT Dutch Boy INTERIOR LATEX FLAT**

**CONFIDENT INTERIOR LATEX FLAT**  
Subtle finish ideal for any decor. Provides washable finish.

**NOW ONLY**

**1 GAL. 41.90**  
~~WAS 9.99~~

**We offer FREE custom paint mixing!**

**ZINSSER**  
**BULLS EYE 1-2-3**  
WHOLE-HOUSE WATER-BASED PRIMER-SEALER  
For all interior/ exterior surfaces.

**16.97** 1 GAL.  
**6.70** QUART

**ZINSSER**  
**PERMA-WHITE**  
Mildew-Proof Bathroom Paint

SEMI GLOSS PERMA-WHITE  
THE PERFECT PAINT FOR BATHROOMS  
Water based.

**19.97** 1 GAL.  
**6.99** QUART

**CUPRUM**  
200 LB DUTY RATING

**TYPE III 6-FOOT HOUSEHOLD WOOD STEP LADDER**  
Handy shelf-lock spreader system.

**26.91**

**STEP LADDER CADDY BLACK**  
**7.49**

**KRAUSE**  
Patented Krause Hinge System  
300 LB DUTY RATING

**12' ALUMINUM MULTIMATIC LADDER**  
Patented Krause hinge system with one-hand release bar. U.L. listed and O.S.H.A. approved.

**AS SEEN ON TV**

**HOMERIGHT**  
**8-PIECE PAINTING KIT**  
Kit includes: Paint stick, Roller cover, Splatter shield, Paint can cover, Fill tube, Roller cleaner, Handy painters tool & video.  
#800345

**31.95**

**EZ PAINT'R**

**7 PIECE "ONE COATER SET"**  
Guaranteed for one coat coverage.  
#70042-50555

**9.99**

**CUPRUM**  
200 LB DUTY RATING

**TYPE III 6-FOOT HOUSEHOLD ALUMINUM LADDER**  
Extra large automatic pail shelf.

**33.26**

**4' '28 5' 31.17**

**\$104**

**ALUMINUM 10' \$154**

**STEEL ADJ. FOLDING 13' 99.97**

# Blowout SPECIAL



Shaw  
RUGS

COTTAGE  
COLLECTION

## "COTTAGE COLLECTION" AREA RUG

Manufactured from premium permacolor fiber for durability and beauty. Caspian-brick, castille-forest cream and callie-navy. #3X10201800  
3'3"X5'3".....19.99

NOW ONLY

**35.98**  
5'6"X7'11"  
WAS \$45

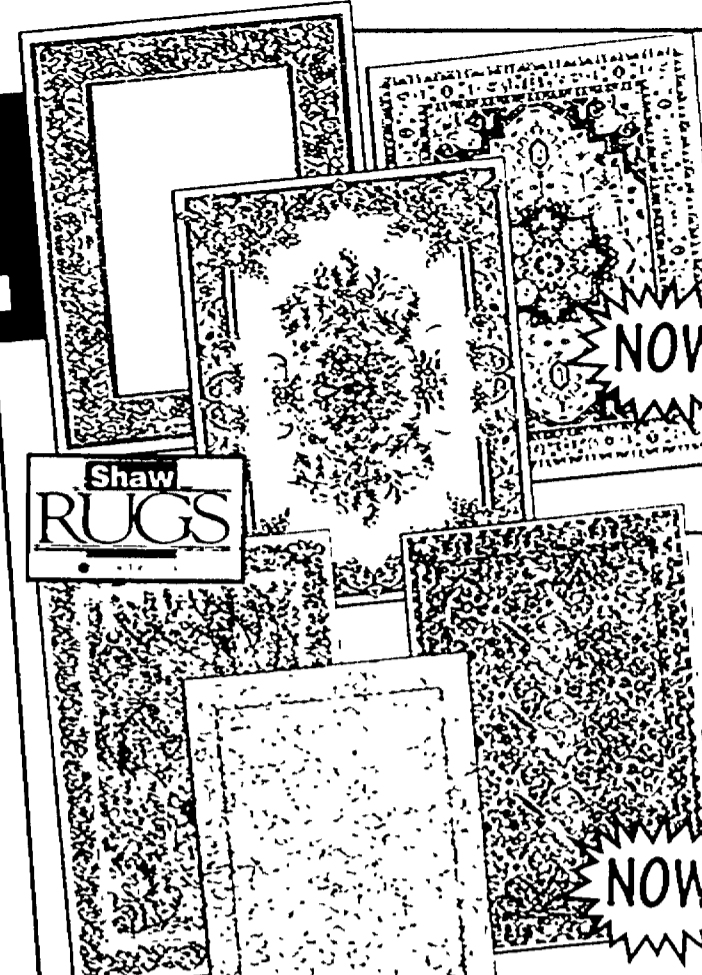

Shaw  
RUGS

5'3"X8'1"  
AREA RUG  
Choose from assorted styles and colors.  
Produced in America.  
#3X30204100

NOW

**84.97** WAS: 89.97

5'5"X7'8"  
AREA RUG  
Choose from assorted styles and colors.  
Produced in America.  
#3X41802500

NOW

**\$109** WAS: \$119

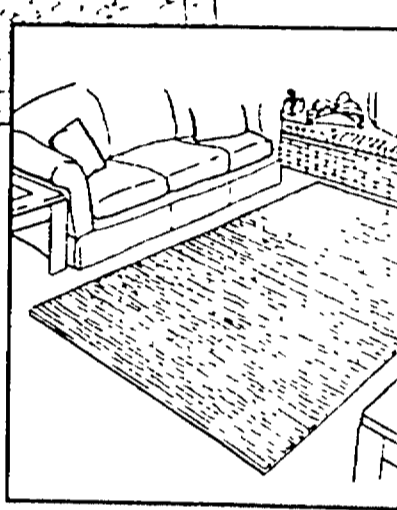

JEFFERSON RUGS

6'X9'  
BROADLOOM RUG  
Assortment of quality plushes. Saxony-cut loop. Action back. #KM695-A

**38.97**

Product shown is representational of selection. Styles, patterns, sizes and/or colors may vary by store. See store for selection.

## Update your home with new carpeting

Commercial level loop.

**46** SQ. FT.

**4.12** Sq. yd.

12' WIDE INDOOR SEAPOINT 20 CARPET  
100% stain resistant olefin.  
#75027-35510,35411 Ln. Ft....**5.49**

**54** SQ. FT.

**4.87** Sq. yd.

12' WIDE INDOOR SULTANA CARPET  
100% stain resistant olefin. Solid textured saxony.  
#75016-10513 10115 Ln. Ft....**6.42**

Commercial level loop.

**34** SQ. FT.

**2.99** Sq. yd.

12' WIDE INDOOR SEAPOINT CARPET  
100% stain resistant olefin. 1/8 gauge construction.  
#75028-35713 Ln. Ft....**3.98**

REBOND CARPET PAD  
Firm and luxurious carpet support.  
#3426-04 6' wide  
**1.99** Ln. ft.

27-INCH TOPPER RUNNER  
Choose from charcoal, tan and grey.  
#2824271092  
**1.99** Ln. ft.

MULTY

24"x72" PRE-CUT RUNNER  
100% machine washable. Extra grip non-slip backing. #99400  
**8.87**

DuraScrape

ASTRO TURF DOORMAT  
Hunter green or autumn gold.  
#FL166, FL135  
YOUR CHOICE!  
**15.87** 23"X35 1/2"

DOOR MATS  
Heavy duty recycled rubber base. Nylon bristle surface.  
#243611C, 2436AFL  
YOUR CHOICE!  
**19.99** 24x36

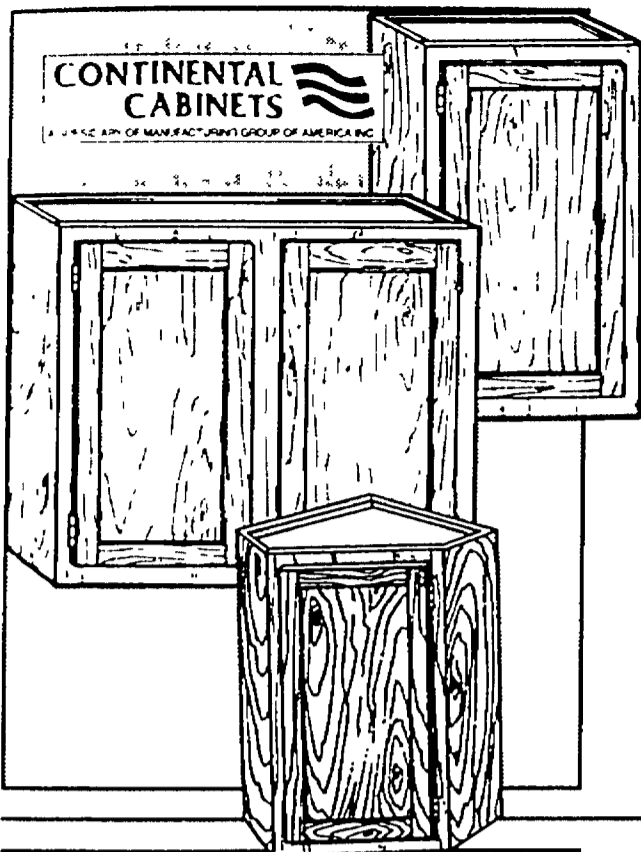

### WALL CABINETS

Solid oak face frame and door. Completely assembled and ready to finish.

1-DOOR	
12X30	\$34.65
15X30	'39
18X30	'42
24X30	'52
2-DOOR	
30X30	'59
36X30	'71
1-DOOR DIAGONAL CORNER	
24X30	'75
UTILITY CABINET	
18X24	'149

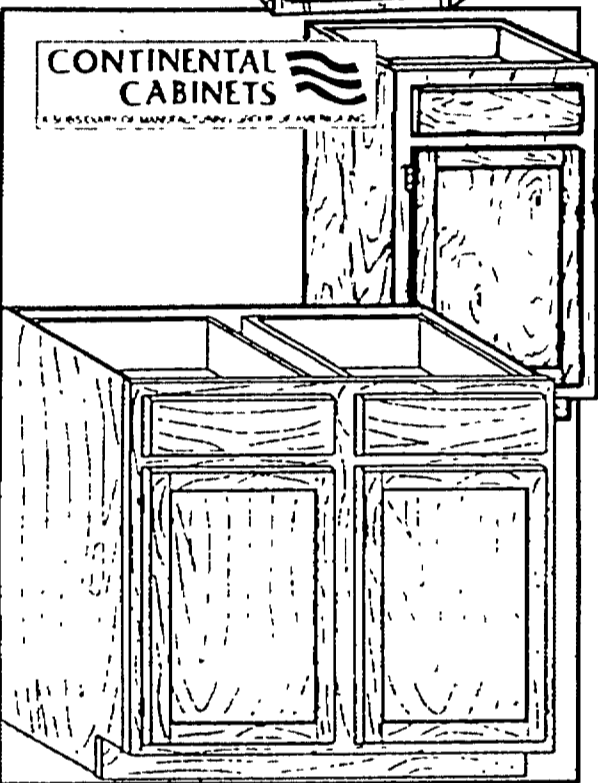

### BASE CABINETS

Solid oak face frame and door. Completely assembled and ready to finish.

1 DOOR/1 DRAWER	
12-INCH	45.15
15-INCH	53.55
18-INCH	60.90
24-INCH	69.30
2 DOOR/2 DRAWER	
30-INCH	82.95
36-INCH	91.35
LAZY SUSAN	
36-INCH	175.35

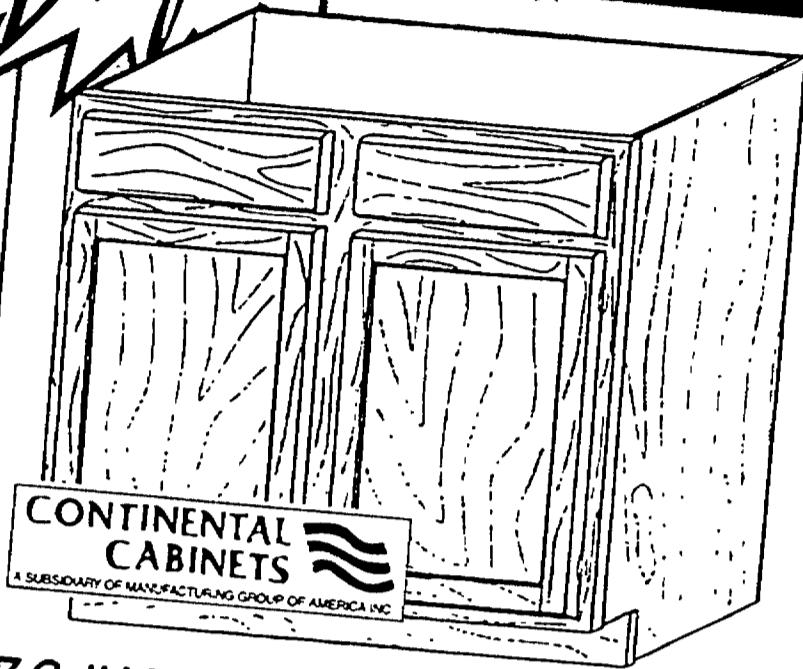

**36-INCH  
2-DOOR  
SINK BASE**  
Solid oak face frame and door. Completely assembled and ready to finish.

NOW ONLY

**69.96**  
WAS: 90.30

60-INCH SINK BASE WAS: 123.90 NOW: \$119

**\$700 of cabinets as low as \$18 per month**

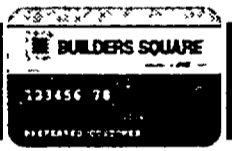

ON A BUILDERS SQUARE CREDIT CARD, WITH APPROVED CREDIT. SEE CREDIT DETAILS ON BACK COVER.

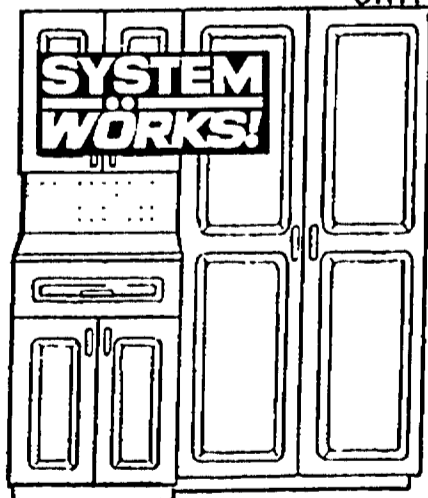

Complete package includes: 1 tall cabinet, 1 base cabinet, 1 wall and 1 countertop. Easy to assemble and install. Ready to paint surface. Assembly hardware included.

### STORAGE CABINETS

1 Raw Countertop #8430G6 Cut to Fit	34.99
2-Door Wall #8410G1	35.99
1 Drawer/2 Door Base #8400G2	68.99
Tall Utility #8436G4 36"x70"x16"	136.49

**276.46**  
Set

Raised panel doors  
Lifetime guarantee



**WHITE OR OAK FINISH  
STORAGE CABINET**  
Square raised panel doors  
3/4" MDF. Solid wood face  
frame. Has two adjustable  
shelves. #SC202130WH•#SCFR21300A

**\$79** Your Choice!  
All items are available  
while quantities last.  
Limited to stock on  
hand. Sorry, no  
rainchecks.

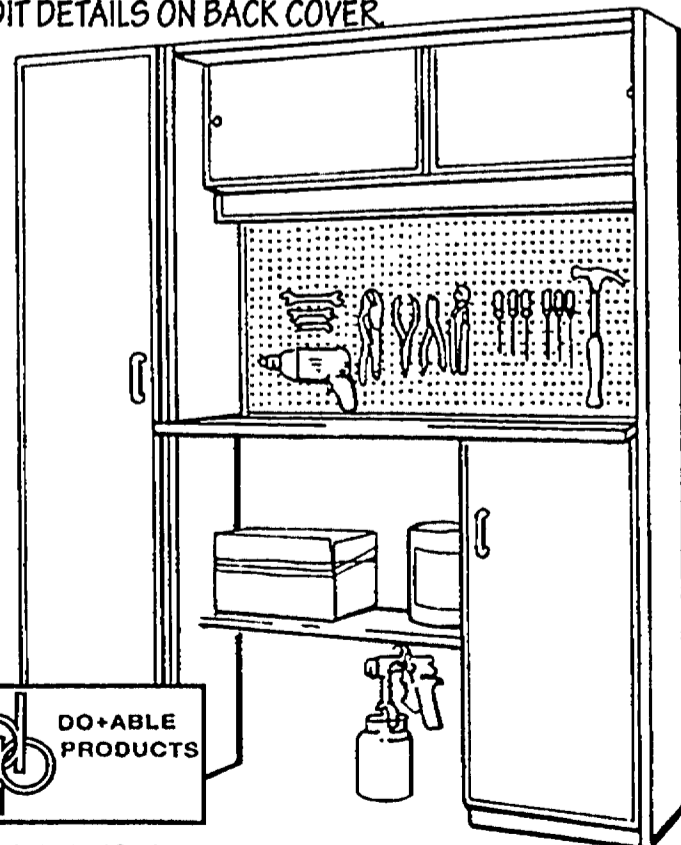

**DO+ABLE  
PRODUCTS**  
**READY-TO-ASSEMBLE  
WORK CENTER KIT \$99**  
White laminated finish.  
#12164

All items are available  
while quantities last.  
Limited to stock on  
hand. Sorry no  
rainchecks

# Blowouts SPECIAL

**Wood Crafters**  
A DIVISION OF TAN U'S SALES CO., INC.

**3 PC. VANITY SET**  
W/ MEDICINE CABINET  
and MARBLE TOP  
YOUR CHOICE! Choose from medium oak or white finish. Fully assembled. European concealed hinges.  
#NM1616P3.NE1816P3

**NOW ONLY**

**WAS \$87**

## Priced to fit any budget!

**ARLINGTON VANITY**  
2 door with drawer at base. Solid oak face frame. Solid wood door frames and drawer front. Arch raised panel door. #PY5024-21-0A

**\$129**

**ALPINE VANITY**  
1 door and 2 drawer. Hardwood face frame and doors. Self closing hinges.  
#PY2030-12-WH

**\$173.95**

**OTHER SIZES AVAILABLE**

**HIGH GLOSS FINISH**

**CONTINENTAL CABINETS**

**24" X 18" LIGHT OAK FINISH**

**30" X 18" WHITE FINISH**

**VANITY TOP NOT INCLUDED**

**BALL BEARING SLIDES IN ALL DRAWERS**

### MARBLE SINK TOP

3 sided non-drip edge. Self draining soap dish. Sleek, scratch resistant.

FAUCET NOT INCLUDED

PROMO WHITE	17x19	\$19	22x25	\$39
	19x25	\$29	22x31	\$54
	19x31	\$39	22x37	\$69
	19x37	\$49	22x49	\$89

WHITE/WHITE	19x25	\$54	22x25	\$74
	19x31	\$64	22x31	\$84
	19x37	\$79	22x37	\$99
	19x49	\$99	22x49	\$129

BEIGE/VEGETE	19x25	\$54	22x25	\$74
	19x31	\$64	22x31	\$84
	19x37	\$79	22x37	\$99
	19x49	\$99	22x49	\$129

**GM GENERAL MARBLE**

**Wood Crafters**

**BUILDERS SQUARE**

**INSTALLS**

**American Standard**

**RENAISSANCE**  
Contemporary "Euro" style. Durable and easy to clean. Available in white.  
ROUND FRONT TOILET  
#4028016020

**SEAT NOT INCLUDED**

**109<sup>88</sup>**

**American Standard**

**ANTIQUITY**  
Classic style. Available in white.  
ROUND FRONT TOILET  
Flush action-strong, efficient.  
#4094015020

**SEAT NOT INCLUDED**

**149<sup>88</sup>**

**PEDESTAL LAVATORY**  
31" high.  
"Euro" style.  
#0034025020

**115<sup>96</sup>**

**PEDESTAL LAVATORY**  
4" center.  
Classic style.  
#0224014020

**149<sup>88</sup>**

**TITON**

**CLASSIC TOILET**  
Vitreous china. White.  
#0701T

**39<sup>91</sup>** SEAT NOT INCLUDED

**STERLING**

**WINDHAM TOILET**  
White. 3 bolt-quick connect installation. #5404515WH

**\$69** WHITE SEAT NOT INCLUDED

**American Standard**

**HAMILTON TOILET**  
Elongated seat included.  
#2092017020

**224<sup>88</sup>** WHITE

ELONGATED FRONT BONE #2092017021 **259.88**

**ASSORTED TOILET SEATS**

Available in many styles and colors to fit any decor and budget.

<b>DECORATOR</b>	<b>SOFT</b>	<b>DESIGNER</b>
<b>9.99</b>	<b>13.95</b>	<b>16.99</b>

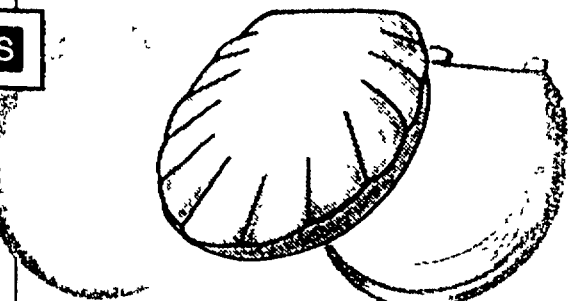

# Light fixtures and more!

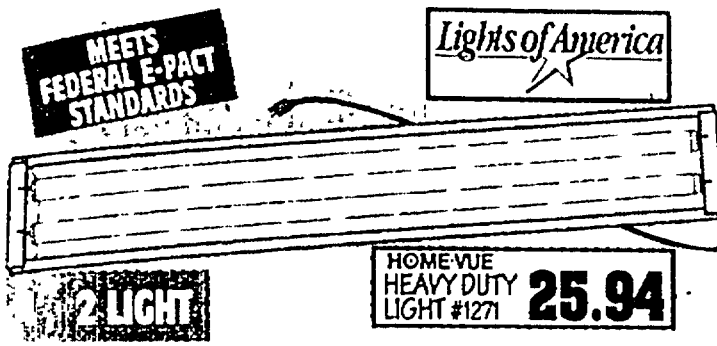

MEETS FEDERAL E-PACT STANDARDS

Lights of America

CLASSIC PLUS™  
High quality steel. Extra long 5' cord. Fully assembled. #8045

2 LIGHT

HOME-VUE HEAVY DUTY LIGHT #1271 **25.94**

**9.99**

USES 2-48" TUBES (NOT INCLUDED)

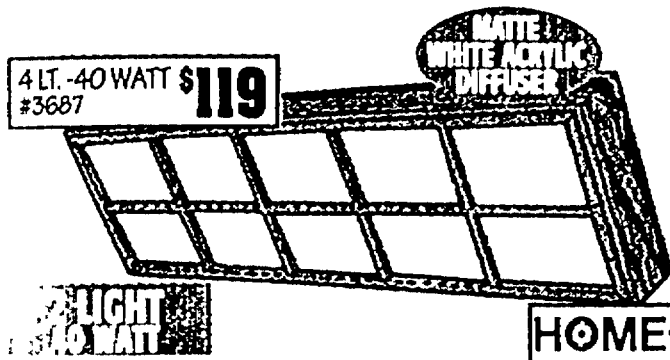

4 LT. - 40 WATT #3687 **\$119**

MATTE WHITE ACRYLIC DIFFUSER

SOFT UNIFORM  
Solid oak frame with matching integral oak grid. #3683

**\$99**

HOME-VUE

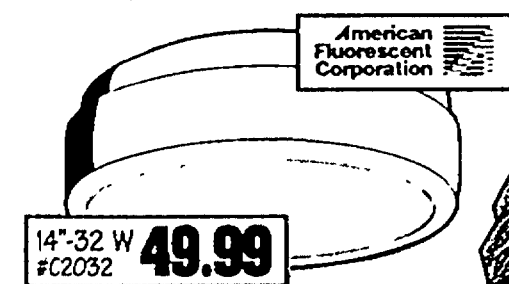

American Fluorescent Corporation

14"-32 W #C2032 **49.99**

FLUORESCENT CIRCLINE  
Molded acrylic lens. Uses 1-22 watt bulb. (Bulb not included). #C2022

**29.99**

11" x 3" FIXTURE

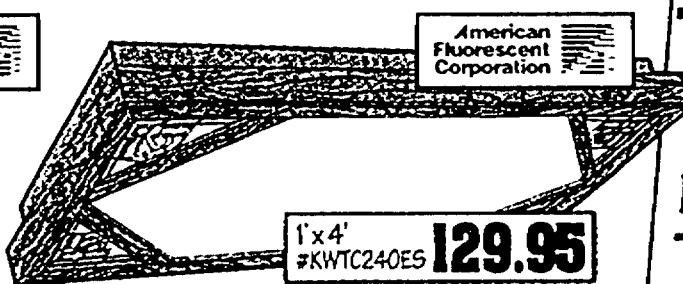

American Fluorescent Corporation

1' x 4' #KWTC240ES **129.95**

BEVELED TIFFANY PANELS  
Solid oak hand stained frame. Easy lift, shift. Energy saving ballast. #KWTC440ES

**159.95**

2' x 4' FIXTURE

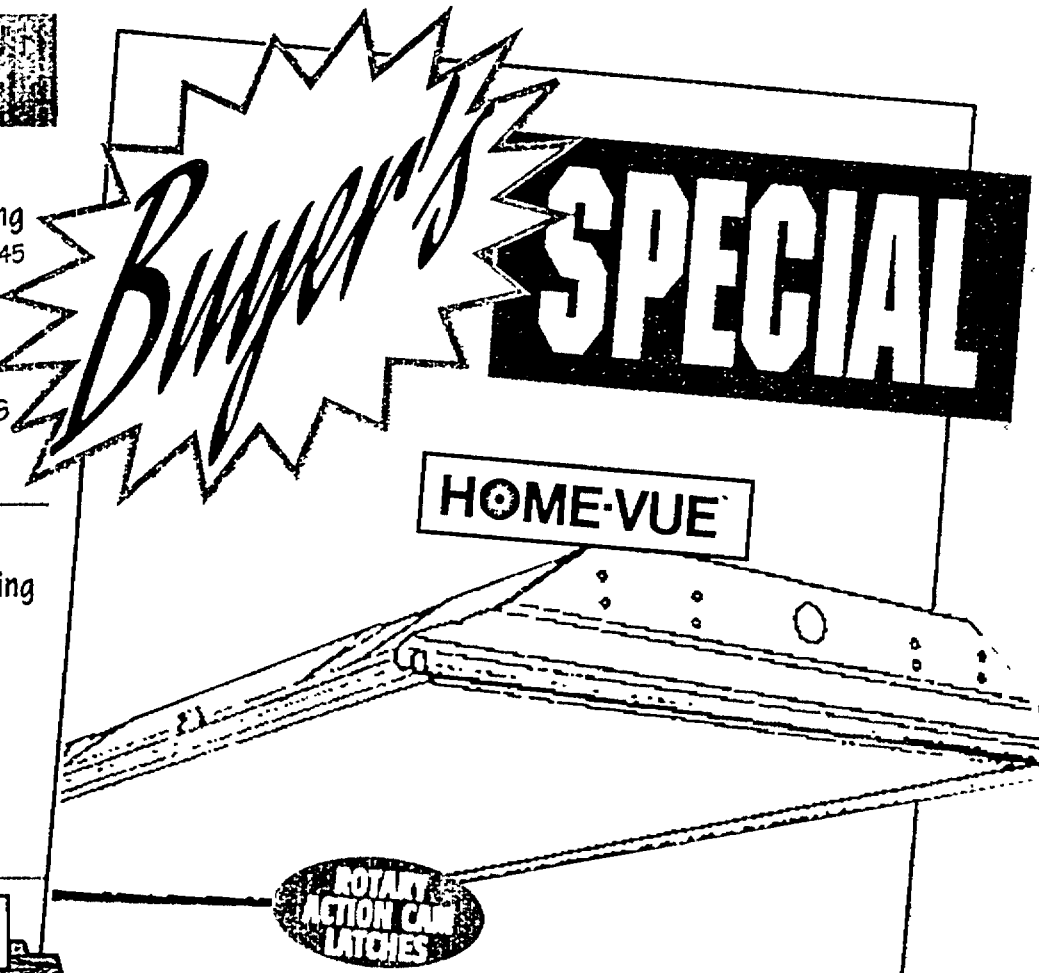

HOME-VUE

ROTARY ACTION CAM LATCHES

4 LT. - 40 WATT RESIDENTIAL TROFFER

Recessed fluorescent fixture with clear prismatic acrylic diffuser in high-reflectance white finish. Lay-in models for suspended T-grid ceiling. #3333A

NOW ONLY

**26.26**

WAS 32.82

Don't see it? We can get it! Try our Special Order catalog for thousands of popular items.

## Replacement bulb values!



12 LIGHT #807203 **\$199**

CATALINA LIGHTING

**29.96**

5 LIGHT WILLIAMSBURG CHANDELIER

Affordable, adds style. Bright brass finish. Easy to install. Includes all mounting hardware and instructions. Size: 17" h x 21". #852502

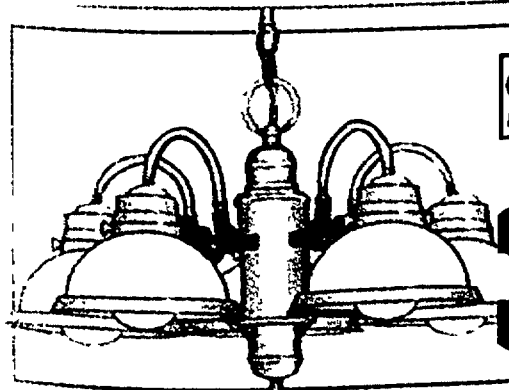

CATALINA LIGHTING

**37.51**

5 LIGHT PRISMATIC DOME CHANDELIER

YOUR CHOICE! Available in bright brass or white finish. Curved arms. Uses 60 watt bulbs. Dome shades. Size: 14" h x 24" w. #834/5,854908-1



SOFT WHITE BULBS **1.39**

YOUR CHOICE! 40, 60, 75 OR 100 WATT

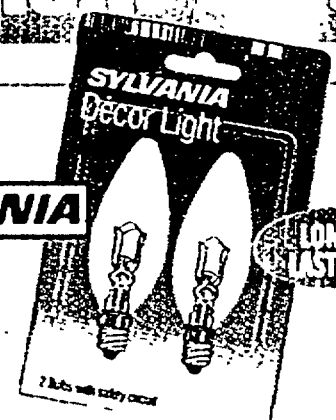

DECOR LITE BULBS **1.84**

FOR CHANDELIERS 2 BULBS WITH SAFETY CIRCUIT



4' DELUXE TUBES **2.55**

2 PK., 40 WATT COOL WHITE #24-475-F40CW2PK

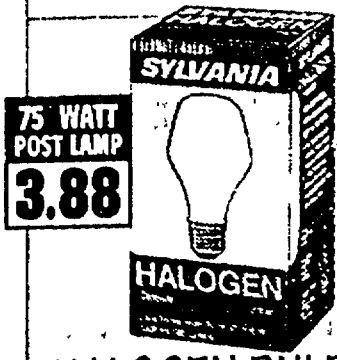

75 WATT POST LAMP **3.88**

HALOGEN BULB **3.88**

YOUR CHOICE! 60, 75 OR 100 WATT, WHITER BRIGHTER LIGHT

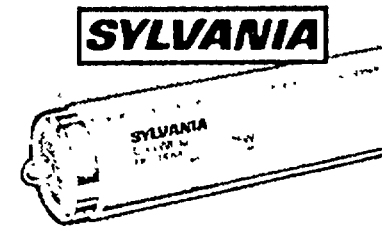

8' COOL WHITE BULB **3.90**

75 WATT DELUXE #29489



COMPACT BULB **9.99**

YOUR CHOICE! 15, 20, 23 WATT LAST 13 X LONGER



**SPECIAL**

**waterBoss™**

WATER CONDITIONING SYSTEM #93000

NOW ONLY

**\$459**

WAS \$570

We'll INSTALL the Water Conditioning System for only... **\$49**

Normal Replacement Installation Job Code #050310504

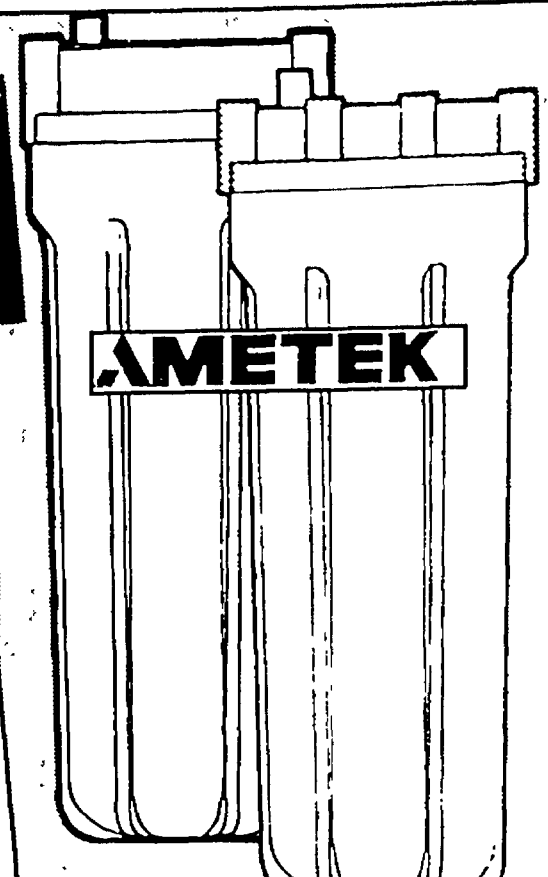

**WHOLE-HOUSE OR UNDER-SINK WATER FILTER**

Whole house filter reduces dirt, sand and silt. Extends life of household appliances and plumbing products. Easy to install. Under sink filter reduces unpleasant taste and odor such as chlorine. 3/8" connection for single faucet applications. #1511801/#158358

**9.90** YOUR CHOICE!

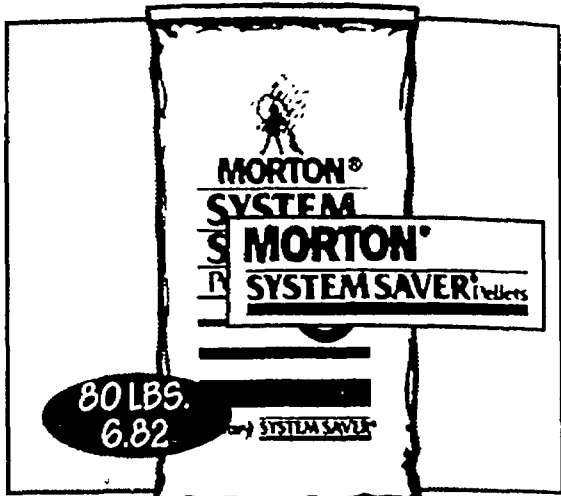

**SYSTEM SAVER™ WATER SOFTENER PELLETS**

99.5% pure salt. Continuous cleansing formula that helps fight mineral build-up.

**3.79** 40 LBS

#150013400

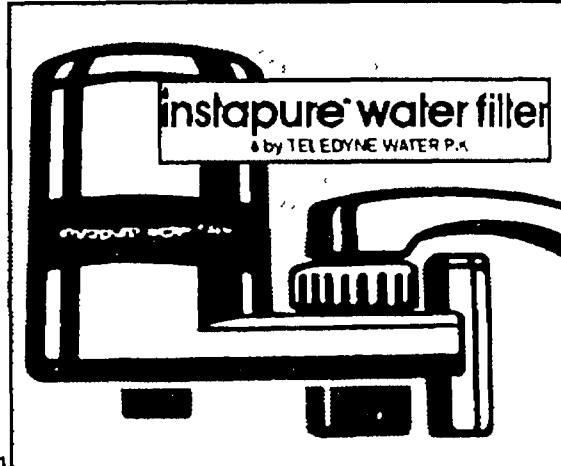

**INSTAPURE™ FAUCET FILTER**

White finish/clear cover. Reduces chlorine, without removing minerals or fluoride. #F6

**11.50**

**Huge savings on quality water heaters!**

**BUILDERS SQUARE**

**INSTALLS**

24 HOUR INSTALLATION AVAILABLE

JOB CODE#050110502

40 GALLON NATURAL GAS WATER HEATER

5 year tank warranty, 1 year parts warranty. T&P valve included with every Reliance water heater.

#5-40-NORT

**\$132**

ALL WATER HEATERS FEATURE A TEMPERATURE AND PRESSURE RELEASE VALVE THAT IS FACTORY INSTALLED FOR OUR CUSTOMER'S SAFETY.

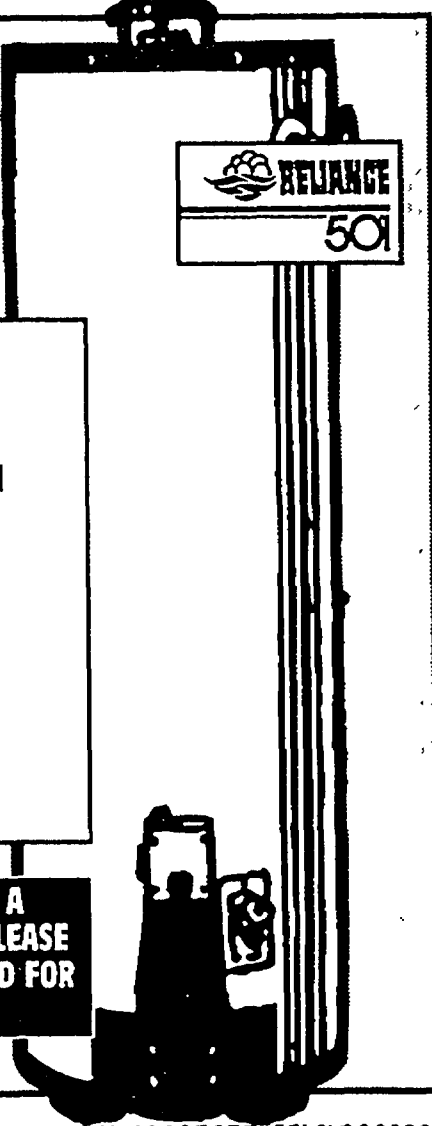

**QUALITY WATER HEATERS**

GAS DESCRIPTION	MODEL NO.	BTU	WARRANTY		PRICE
			TANK	PARTS	
▶ 30 GAL. TALL NAT. GAS	#5-30-NORT	30,000	5 YR.	1 YR.	'132
▶ 40 GAL. TALL NAT. GAS	#5-40-NORT	32,000	5 YR.	1 YR.	'132
▶ 40 GAL. TALL PROP. GAS	#5-40-PORT	30,000	5 YR.	1 YR.	'209
▶ 40 GAL. TALL NAT. GAS STA-K	#8-40-NKRT	35,000	8 YR.	8 YR.	199.95
▶ 40 GAL. TALL NAT. GAS STA-K	#10-40-NART	40,000	10 YR.	10 YR.	229.95
▶ 50 GAL. TALL NAT. GAS	#5-50-NORT	32,000	5 YR.	1 YR.	'188
▶ 50 GAL. TALL NAT. GAS STA-K	#10-50-NART	40,000	10 YR.	10 YR.	'289
ELECTRIC DESCRIPTION	VOLTAGE	MODEL NO.	WARRANTY		PRICE
			TANK	PARTS	
▶ 2 GAL. POU	110V	#1-2-1SUS-K	1 YR.	90 DAYS	'128
▶ 4 GAL. POU	110V	#1-4-1SUS-K	1 YR.	90 DAYS	'138
▶ 10 GAL. MIDGET	110V	#5-10-1SMS-K	5 YR.	1 YR.	'139
▶ 20 GAL. MIDGET	110V	#5-20-1SMS-K	5 YR.	1 YR.	'155
▶ 40 GAL. SHORT	210V	#5-40-2ORS	5 YR.	1 YR.	175.66
▶ 52 GAL. SHORT	210V	#5-52-2ORS	5 YR.	1 YR.	'169
▶ 52 GAL. TALL STA-K	210V	#10-52-2ART	10 YR.	10 YR.	'239

\* #TACLA001191C, #62623, #PCB1017705, #105954, #2102085035, #TACLB002928C, #210208503, #TACLA000876, #MN0006039, #0003812M4, ICT#1481, 3208, 2888, 2728, #41925



**BUILDERS SQUARE**  
**INSTALLS**

**CABINET REFACING**

Custom door and drawer fronts give your cabinets new life. Includes replacement of old fronts and covering all exterior surfaces with beautiful finishes. Durable covering permanently attached for lasting good looks. Normal Installation.

Receive a free Counter Top up to 10 ft. with any complete Cabinet Refacing project.

JOB CODE #0760

**BUILDERS SQUARE PROVIDES:**

- Professional Installation
- Labor Guarantee
- Dependability
- Installers are Insured & Licensed
- Credit Terms Available

#TACLA001191C, #62623, #PC81017705, #105954, #2102085035, #TACLB002928C, #210208503, #TACLA000876, #MN0006039, #0003812M4, ICT#1481, 3208, 2888, 2728

**FOR AN ESTIMATE CALL 1-800-227-INSTALL (4678)**

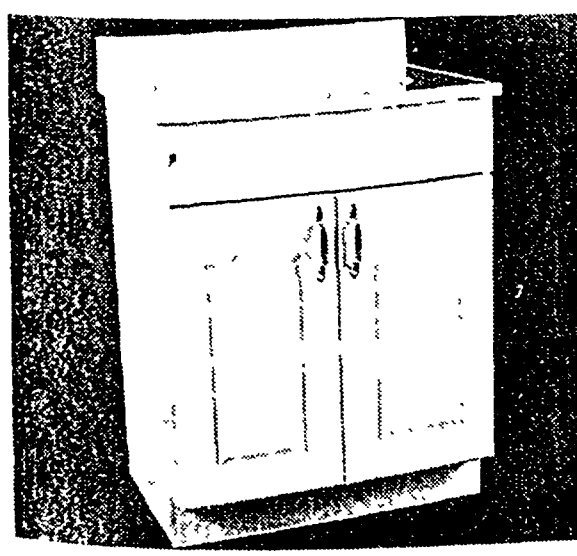

**VANITY & TOP INSTALLATION**  
 Replace your old outdated vanity. Hundreds of styles to choose from. Moving plumbing or electrical connections, or updating to comply with new building codes not included. Normal Replacement Installation.  
 JOB CODE #0509

**\$145** LABOR ONLY

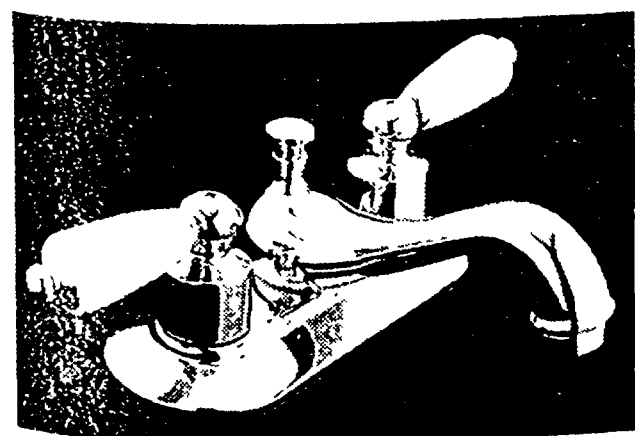

**FAUCET INSTALLATION**  
 Includes disconnecting and removal of existing faucet and replacement with new faucet. Additional plumbing and permits if required are not included.  
**\$58** LABOR ONLY  
 Normal Replacement Installation  
 JOB CODE #0510



**SHOWER & TUB INSTALLATION**  
 Includes installation in a reasonably square opening. Haulaway of existing door additional. Normal Installation.  
 JOB CODE #0506

**LABOR ONLY**

**\$68**

# HOT BUYS 4 DAYS ONLY

**4 DAYS ONLY**

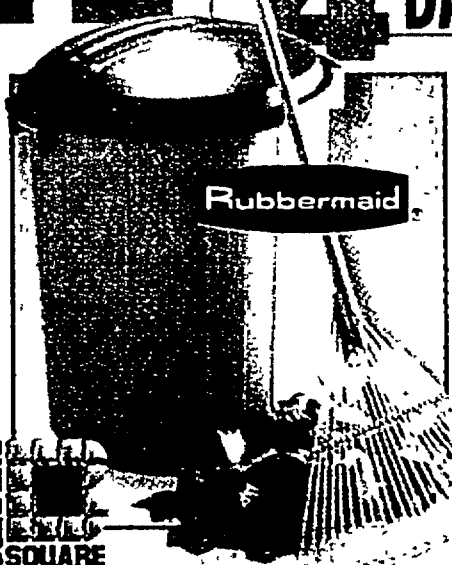

**32 GAL. ROUGHNECK REFUSE CONTAINER**  
Snap-on lid maintains shape, locks in contents. Molded in handles easy to lift. #2897

WAS: **9.98** **6.96** NOW

**THURS. JAN. 23-SUN. JAN. 26**

**4 DAYS ONLY**



**10' X 25' X .004 CLEAR or BLACK POLYSHEETING**  
Can be used for ground cover, construction projects or to protect outside materials from the weather.

WAS: **4.71** **2.96** NOW

**THURS. JAN. 23-SUN. JAN. 26**

**4 DAYS ONLY**

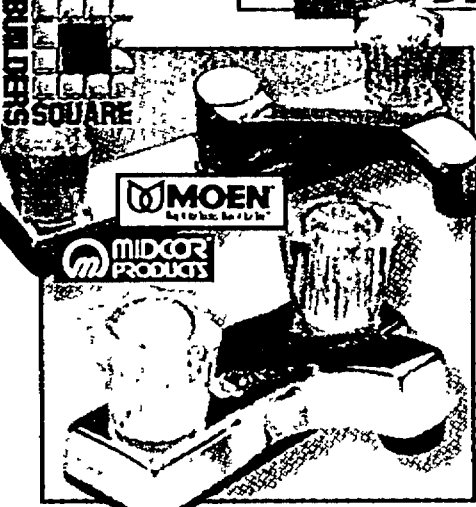

**NON-METALLIC KITCHEN or BATH FAUCET**  
#271091#84407

KITCHEN FAUCET WAS: **12.88**  
BATH FAUCET WAS: **13.88**

**7.96** NOW YOUR CHOICE

**THURS. JAN. 23-SUN. JAN. 26**

**4 DAYS ONLY**



**10.3 OZ. PAINTER'S ACRYLIC LATEX CAULK**  
Cleans up with water. Paintable, within 30 minutes. Available in white. #18065

WAS: **1.66** **88¢** NOW

**THURS. JAN. 23-SUN. JAN. 26**

ASK US ABOUT OUR SENIOR CITIZEN'S DISCOUNT PROGRAM!

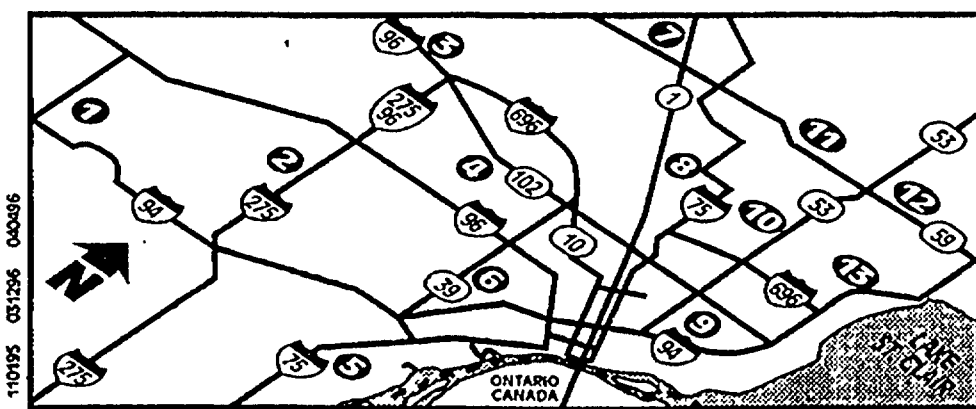

- 1 YPSILANTI 2820 WASHTENAW AVE...434-5210
- 2 CANTON 42000 FORD RD.....981-8400
- 3 NOVI 43610 WEST OAKS DR.....344-8855
- 4 LIVONIA 2965 7 MILE RD.....442-8580
- 5 SOUTHGATE 14800 DIX-TOLEDO RD..246-8500
- 6 DEARBORN 5951 MERCURY DR.....336-6900
- 7 WATERFORD 2214 SUMMIT MALL RD.681-4884
- 8 ROYAL OAK 4949 COOLIDGE HWY.....435-7910
- 9 DETROIT 8400 E. 8 MILE.....893-4900
- 10 STERLING HTS. 33801 VAN DYKE ...826-8330
- 11 ROCHESTER HILLS 223 AUBURN E. .852-7744
- 12 UTICA 45160 UTICA PARK BLVD.....726-5800
- 13 ROSEVILLE 31510 GRATIOT AVE.....294-8080
- 14 PORT HURON 4715 24TH AVE.....385-3844

NOT SHOWN  
PRINTED IN THE U.S.A. DET

**STORE HOURS: MONDAY - SATURDAY: 7:00 A.M. to 9:00 P.M. SUNDAY: 9:00 A.M. to 6:00 P.M.**

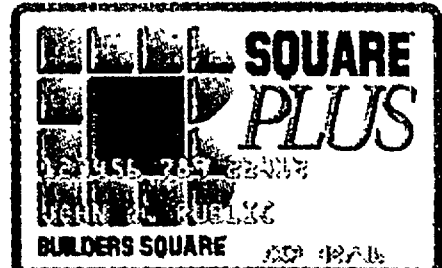
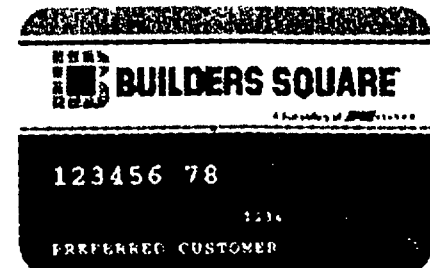

\* PRICE PROMISE DETAILS: We will match exact prices on identical merchandise from local competitors. Same manufacturer and model numbers. Limited to stock on hand. We reserve the right to limit quantities. Applies to non-member club prices and catalog prices including freight. Does not include clearance or going out of business sales.

\* CREDIT DETAILS: With approved credit. The number of months you will pay and the amount of your minimum monthly payments will depend on additional purchases and your balance. Payments fluctuate according to account balance.

©1997 BUILDERS SQUARE, INC. AD#5211

Limited quantities. Sorry, no rainchecks. At least one of each item available in the store at the beginning of the sale. Not responsible for typographical errors.